



USER'S MANUAL
NX INVERTERS
FI9 – FI14

AT LEAST THE 10 FOLLOWING STEPS OF THE *START-UP QUICK GUIDE* MUST BE PERFORMED DURING THE INSTALLATION AND COMMISSIONING.

IF ANY PROBLEMS OCCUR, PLEASE CONTACT YOUR LOCAL DISTRIBUTOR.

Start-up Quick Guide

1. Check that the delivery corresponds to your order, see Chapter 3.
2. Before taking any commissioning actions, read carefully the safety instructions in Chapter 1.
3. Before the mechanical installation, check the minimum clearances around the unit and check the ambient conditions in Chapter 5.
4. Check the size of the motor cable, DC supply cable, and mains fuses, and check the cable connections. Read Chapters 6.1.1.1 – 6.1.1.6.
5. Follow the installation instructions, see Chapter 6.1.1.8.
6. The sizes and earthing of control connections are explained in Chapter 6.2.1.
7. If the Start-Up wizard is active, select the language you want the keypad and the application to use and confirm by pressing the enter button. If the Start-Up wizard is not active, follow the instructions in 7a and 7b below.
8. 7a. Select the language of the keypad from Menu M6, page 6.1. Instructions on using the keypad are given in Chapter 7.
9. 7b. Select the application you want to use from Menu M6, page 6.2. Instructions on using the keypad are given in Chapter 7.
10. All parameters have factory default values. To ensure proper operation, check the rating plate data for the values below and the corresponding parameters of parameter group G2.1.
 - nominal voltage of the motor
 - nominal frequency of the motor
 - nominal speed of the motor
 - nominal current of the motor
 - motor $\cos\phi$

All parameters are explained in the All in One Application Manual.

11. Follow the commissioning instructions, see Chapter 8.
12. The Vacon NX Inverter is now ready for use.

Vacon Plc is not responsible for the use of the inverters against the instructions.

CONTENTS

VACON NXI USER'S MANUAL

INDEX

1	SAFETY
2	EU DIRECTIVE
3	RECEIPT OF DELIVERY
4	TECHNICAL DATA
5	INSTALLATION
6	CABLING AND CONNECTIONS
7	CONTROL KEYPAD
8	COMMISSIONING
9	FAULT TRACING

ABOUT THE VACON NXI USER'S MANUAL

Congratulations for choosing Vacon NX Inverters!

The User's Manual will provide you with the necessary information about the installation, commissioning and operation of Vacon NX Inverters. We recommend that you carefully study these instructions before powering up the inverter for the first time.

In the All in One Application Manual you will find information about the different applications included in the All in One Application Package. Should these applications not meet the requirements of your process, please contact the manufacturer for information on special applications.

This manual is available in both paper and electronic editions. We recommend you to use the electronic version if possible. If you have the **electronic version** at your disposal, you will be able to benefit from the following features:

The manual contains several links and cross-references to other locations in the manual, which makes it easier to move around in the manual. The reader can thus easily find and check things.

The manual also contains hyperlinks to web pages. To visit these web pages through the links, you must have an internet browser installed on your computer.

Vacon NXI User's Manual

Index

Document code: ud01063B
Date: 18.10.2006

1.	SAFETY	7
1.1	Warnings	7
1.2	Safety instructions.....	7
1.3	Earthing and earth fault protection	8
1.4	Running the motor.....	8
2.	EU DIRECTIVE	9
2.1	CE marking	9
2.2	EMC directive	9
2.2.1	Introduction.....	9
2.2.2	Technical criteria.....	9
2.2.3	Vacon inverter EMC classification	9
2.2.4	Manufacturer's declaration of conformity.....	9
3.	RECEIPT OF DELIVERY	11
3.1	Type designation code.....	11
3.1.1	FI9 – FI14.....	11
3.1.2	The standard features of NXI inverters	12
3.2	Storage.....	13
3.3	Maintenance.....	13
3.4	Warranty.....	14
4.	TECHNICAL DATA	15
4.1	Introduction.....	15
4.2	Power ratings.....	17
4.2.1	Vacon NXI_xxxx 5 – Supply voltage 465-800 Vdc, Motor voltage 380–500 Vac	17
4.2.2	Vacon NXI_xxxx 6 – Supply voltage 640-1100 Vdc, Motor voltage 525–690 Vac.....	18
4.3	Technical information.....	19
5.	INSTALLATION	22
5.1	Mounting	22
5.2	Fan cooling.....	29
5.2.1	Frames FI9 to FI14.....	29
5.2.2	Arranging ventilation of the enclosure	30
6.	CABLING AND CONNECTIONS	33
6.1	Power unit.....	33
6.1.1	Power connections	41
6.1.1.1	DC supply and motor cables	41
6.1.1.2	Control cable	41
6.1.1.3	Fuses, NXI_xxxx 5.....	41
6.1.1.4	Fuses, NXI_xxxx 6.....	42
6.1.1.5	Inverter supply and motor cables , NXI_xxxx 5	43
6.1.1.6	Terminal sizes, NXI_xxxx 5	44
6.1.1.7	Inverter supply and motor cables, NXI_xxxx 6	44

6.1.1.8	Terminal sizes, NXI_ xxxx 6	46
6.1.2	Installation instructions	47
6.1.2.1	Vacon NXI frames	49
6.1.3	Cable installation and the UL standards	51
6.1.4	Cable and motor insulation checks	51
6.2	Control unit	52
6.2.1	Control connections	53
6.2.1.1	Control cables	54
6.2.1.2	Galvanic isolation barriers	54
6.2.2	Control terminal signals	55
6.2.2.1	Digital input signal inversions.....	56
6.2.2.2	Jumper selections on the OPT-A1 basic board	57
7.	CONTROL KEYPAD	59
7.1	Indicators on the keypad display	59
7.1.1	Drive status indications	59
7.1.2	Control place indications.....	60
7.1.3	Status LEDs (green – green – red).....	60
7.1.4	Text lines.....	61
7.2	Keypad push-buttons.....	62
7.2.1	Button descriptions	62
7.3	Navigation on the control keypad.....	63
7.3.1	Monitoring menu (M1)	65
7.3.2	Parameter menu (M2)	66
7.3.3	Keypad control menu (M3)	68
7.3.3.1	Selection of control place	68
7.3.3.2	Keypad reference	69
7.3.3.3	Keypad direction.....	69
7.3.3.4	Stop button activated.....	69
7.3.4	Active faults menu (M4).....	70
7.3.4.1	Fault types	70
7.3.4.2	Fault codes	72
7.3.4.3	Fault time data record.....	75
7.3.5	Fault history menu (M5)	76
7.3.6	System menu (M6).....	77
7.3.6.1	Selection of language.....	80
7.3.6.2	Application selection	80
7.3.6.3	Copy parameters	81
7.3.6.4	Parameter comparison	83
7.3.6.5	Safety	84
7.3.6.6	Keypad settings	86
7.3.6.7	Hardware settings.....	88
7.3.6.8	System info	90
7.3.7	Expander board menu (M7).....	94
7.4	Further keypad functions	95
8.	COMMISSIONING.....	96
8.1	Safety.....	96
8.2	Commissioning the inverter	96
9.	FAULT TRACING.....	99

1. SAFETY



ONLY A COMPETENT ELECTRICIAN MAY CARRY OUT THE ELECTRICAL INSTALLATION



1.1 Warnings

 WARNING	1	The components of the power unit of the inverter are live when the Vacon NX is connected to DC supply. Coming into contact with this voltage is extremely dangerous and may cause death or severe injury. The control unit is isolated from mains potential.
	2	The DC supply and motor terminals are live when the Vacon NX is connected to DC supply, even if the motor is not running.
	3	The control I/O-terminals are isolated from the mains potential. However, the relay outputs and other I/O-terminals may have dangerous control voltage present even when the Vacon NX is disconnected from the DC supply.
	4	The inverter has a large capacitive leakage current.
	5	If the inverter is used as a part of a machine, the machine manufacturer is responsible for providing the machine with a main switch (EN 60204-1).
	6	Only spare parts delivered by Vacon can be used.

1.2 Safety instructions

	1	The Vacon NX inverter is meant for fixed installations only.
	2	Do not perform any measurements when the inverter is connected to the DC supply.
	3	After having disconnected the inverter from the DC supply, wait until the fan stops and the indicators on the keypad go out (if no keypad is attached see the indicator through the keypad base). Wait 5 more minutes before doing any work on Vacon NX connections. Do not even open the cover before this time has expired.
	4	Do not perform any voltage withstand tests on any part of Vacon NX. There is a certain procedure according to which the tests shall be performed. Ignoring this procedure may result in damaged product.
	5	Prior to measurements on the motor or the motor cable, disconnect the motor cable from the inverter.
	6	Do not touch the components on the circuit boards. Static voltage discharge may damage the components.
	7	Before connecting the inverter to DC supply, make sure that the Vacon NX front and cable covers are closed.

1.3 Earthing and earth fault protection

The Vacon NX inverter must always be earthed with an earthing conductor connected to the earthing terminal. 

The earth fault protection inside the inverter only protects the inverter against earth faults in the motor or the motor cable.

Due to the high capacity currents present in the inverter, fault current protective switches may not function properly. If fault current protective switches are used, they need to be tested with earth fault currents present during possible fault situations.

1.4 Running the motor

Warning symbols

For your own safety, please pay special attention to the instructions marked with the following symbols:



= *Dangerous voltage*



= *General warning*



= *Hot surface – Risk of burn*

MOTOR RUN CHECK LIST

 WARNING	1	Before starting the motor, check that the motor is mounted properly and ensure that the machine connected to the motor allows the motor to be started.
	2	Set the maximum motor speed (frequency) according to the motor and the machine connected to it.
	3	Before reversing the motor, make sure that this can be done safely.
	4	Make sure that no power correction capacitors are connected to the motor cable.
	5	Make sure that the motor terminals are not connected to mains potential.

2. EU DIRECTIVE

2.1 CE marking

The CE marking on the product guarantees the free movement of the product within the EEA (European Economic Area). It also guarantees that the product complies with applicable directives (for example, the EMC directive and other possible so-called new method directives).

Vacon NX inverters carry the CE label as a proof of compliance with the Low Voltage Directive (LVD) and the Electro Magnetic Compatibility (EMC) directive. [SGS FIMKO](#) has acted as the Competent Body.

2.2 EMC directive

2.2.1 Introduction

The EMC Directive provides that the electrical apparatus must not excessively disturb the environment it is used in, and, on the other hand, it shall have an adequate level of immunity toward other disturbances from the same environment.

The compliance of Vacon NX inverters with the EMC directive is verified with Technical Construction Files (TCF) and checked and approved by SGS FIMKO, which is a [Competent Body](#). The Technical Construction Files are used to authenticate the conformity of Vacon inverters with the Directive because it is impossible to test such a large product family in a laboratory environment and because the combinations of installation vary greatly.

2.2.2 Technical criteria

Our basic idea was to develop a range of inverters offering the best possible usability and cost-efficiency. EMC compliance was a major consideration from the outset of the design.

2.2.3 Vacon inverter EMC classification

Factory delivered Vacon NX inverters are Class T equipment, which fulfil all **EMC immunity requirements** (standards EN 50082-1, 50082-2 and EN 61800-3).

Class T:

Class T equipment have a small earth leakage current and can be used with floating DC input.

Warning: This product is of the restricted sales distribution class according to IEC 61800-3. In residential areas, this product may cause radio interference in which case the user may be required to take adequate measures.

2.2.4 Manufacturer's declaration of conformity

The following page presents the photocopy of the Manufacturer's Declaration of Conformity assuring the compliance of Vacon Inverters with the EMC-directives



EU DECLARATION OF CONFORMITY

We

Manufacturer's name: Vacon Oyj
Manufacturer's address: P.O.Box 25
 Runsorintie 7
 FIN-65381 Vaasa
 Finland

hereby declare that the product

Product name: Vacon NX Common DC bus Products

Model designation: Vacon NXI 0004 5... to 2700 5
 Vacon NXI 0004 6... to 2250 6
 Vacon NXA 0004 5... to 2700 5
 Vacon NXA 0004 6... to 2250 6
 Vacon NXF 0004 6... to 2700 5
 Vacon NXF 0004 6... to 2250 6
 Vacon NXN 0400 5... to 0650 5
 Vacon NXN 0400 6... to 0650 6
 Vacon NXB 0004 5... to 2700 5
 Vacon NXB 0004 6... to 2250 6

has been designed and manufactured in accordance with the following standards:

Safety: EN61800-5-1 (2003)
EMC: Factory delivered Vacon NX inverter modules comply with the requirements of category 4 equipment according to EN 61800-3 (2004).

It is ensured through internal measures and quality control that the product conforms at all times to the requirements of the current Directive and the relevant standards.

In Vaasa, 3rd of April, 2006

 Vesa Laisi
 President

The year the CE marking was affixed: 2005

3. RECEIPT OF DELIVERY

Vacon NX inverters have undergone scrupulous tests and quality checks at the factory before they are delivered to the customer. However, after unpacking the product, check that no signs of transportation damage is to be found on the product and that the delivery is complete (compare the type designation of the product to the code below, see Figure 3-1

Should the drive have been damaged during the shipping, please contact primarily the cargo insurance company or the carrier.

If the delivery does not correspond to your order, contact the supplier immediately.

3.1 Type designation code.

3.1.1 F19 – F114

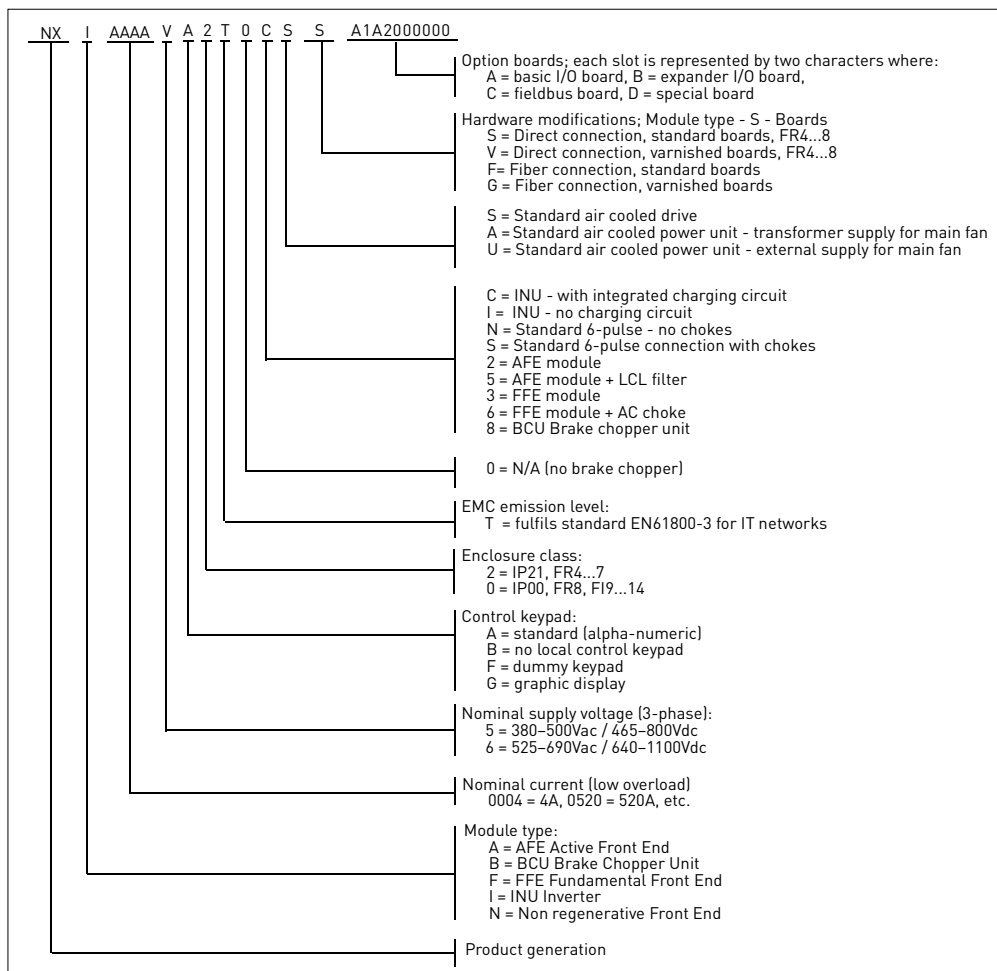

Figure 3-1 Vacon NX type designation code, F19 – F114

3.1.2 The standard features of NXI inverters

INVERTER	
Sales code	NXI_AAAA 5/6
Standard features of FI9, FI10, FI12, FI13 and FI14	Air cooling
	Alphanumeric control panel with fiber connection
	EMC class T (EN 61800-3 for IT networks)
	Safety CE / UL
	External charging required
	I/O modules A1 & A2
	IP00

Table 3-1. The standard features of NXI inverters

3.2 Storage

If the inverter is to be stored before use, make sure that the ambient conditions are acceptable:

Storage temperature	-40...+70°C
Relative humidity	<95%, no condensation

When inverter units are stored without voltage being applied, the recharging of the capacitors should be done at least once a year by connecting voltage into the unit and keeping it powered at least for 1 hour.

If the storing time is much longer than one year, the recharging of the capacitors has to be carried out so that the possible high leakage current through the capacitors is limited. The best alternative is to use DC-power supply with adjustable current limit. Current limit has to be set for example to 300...500mA and DC-power supply has to be connected to the B+/B- terminals (DC supply terminals).

DC-voltage must be adjusted up to nominal DC-voltage level of the unit ($1.35 \cdot U_n$ ac) and shall be supplied at least for 1 hour.

If DC-voltage is not available and unit has been stored much longer than 1 year de-energized, consult factory before connecting the power.

3.3 Maintenance

All technical devices, drives as well, need a certain amount of care-taking and failure preventive maintenance. To maintain trouble-free operation of the drive, environmental conditions, as well as load, line power, process control, etc. have to be within specifications, determined by manufacturer.

If all conditions are in accordance with the manufacturer's specifications, there are no other concerns, but to provide a cooling capacity high enough for the power- and control circuits. This requirement can be met by making sure, that the cooling system works properly. Operation of cooling fans and cleanness of the heat sink should be verified regularly.

Regular maintenance is recommended to ensure trouble free operation and long lifetime of the drive. At least the following things should be included in the regular maintenance.

TABLE 5. Maintenance interval

Interval	Maintenance
12 months (if unit stored)	Capacitor reforming, see separate instructions
6 - 24 months (depending on environment)	Check the input and output terminals and control I/O-terminals. Clean the cooling tunnel Check operation of cooling fan, check for corrosion on terminals, busbars and other surfaces Check the door filters in the case of cabin installation
5 - 7 years	Change the cooling fans Main fan Internal IP54 fan Cabinet cooling fan/filter
5 - 10 years	Change the DC bus capacitors

It is also recommended to record all actions and counter values with dates and time for follow up of maintenance.

3.4 Warranty

Only manufacturing defects are covered by the warranty. The manufacturer assumes no responsibility for damages caused during or resulting from transport, receipt of the delivery, installation, commissioning or use.

The manufacturer shall in no event and under no circumstances be held responsible for damages and failures resulting from misuse, wrong installation, unacceptable ambient temperature, dust, corrosive substances or operation outside the rated specifications.

Neither can the manufacturer be held responsible for consequential damages.

The Manufacturer's warranty period is 18 months from the delivery or 12 months from the commissioning whichever expires first (General delivery terms NL92/Orgalime S92).

The local distributor may grant a warranty time different from the above. This warranty time shall be specified in the distributor's sales and warranty terms. Vacon assumes no responsibility for any other warranties than that granted by Vacon itself.

In all matters concerning the warranty, please contact your distributor first.

4. TECHNICAL DATA

4.1 Introduction

The figure below presents the block diagram of the Vacon NX inverter. The inverter mechanically consists of two units, the Power Unit and the Control Unit.

The Power Unit contains an inverter bridge which consists of IGBT switches and produces a symmetrical, 3-phase PWM-modulated AC voltage to the motor.

The Motor and Application Control Block is based on microprocessor software. The microprocessor controls the motor based on the information it receives through measurements, parameter settings, control I/O and control keypad. The motor and application control block controls the motor control ASIC which, in turn, calculates the IGBT positions. Gate drivers amplify these signals for driving the IGBT inverter bridge.

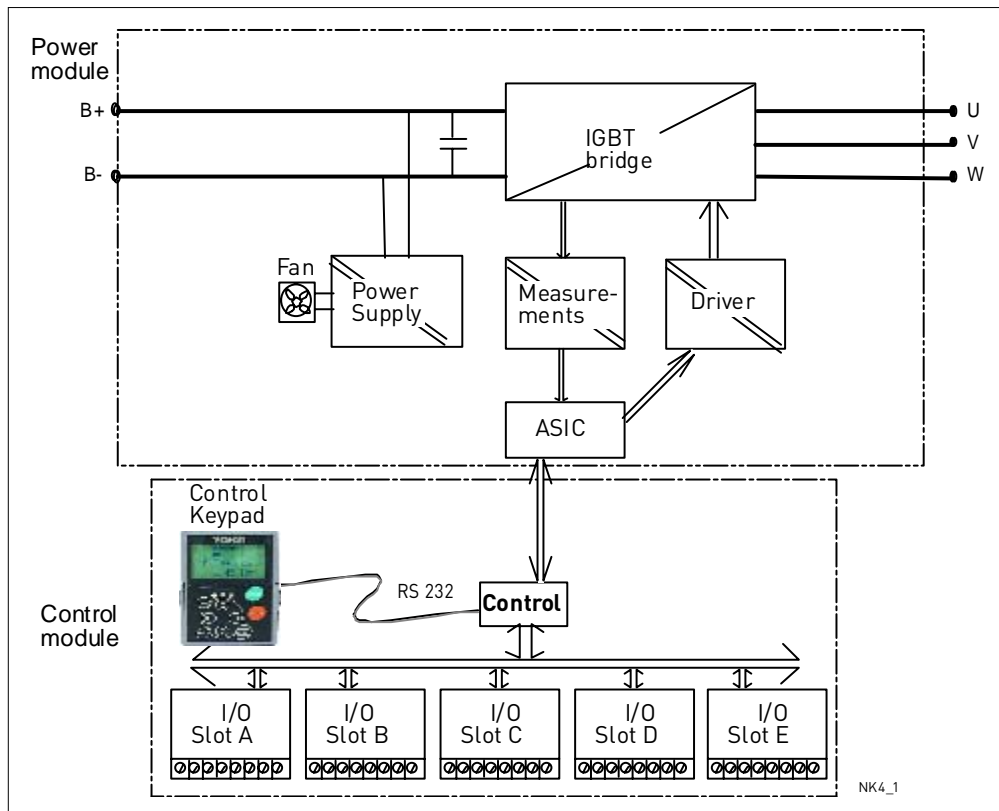

Figure 4-1. The block diagram of Vacon NXI inverter

The control keypad constitutes a link between the user and the inverter. The control keypad is used for parameter setting, reading status data and giving control commands. It is detachable and can be operated externally and is connected via a cable to the inverter. Instead of the control keypad, a PC can be used to control the inverter if connected through a similar cable (VACON RS232PC –1.5M).

The basic control interface and the parameters (the Basic Application) are easy to use. If a more versatile interface or parameters are required, a more suitable application can be chosen from the "All in One+" Application Package. See the "All in One+" Application Manual for more information on the different applications.

Optional I/O expander boards that increase the number of inputs and outputs to be used are also available. For more information, contact the [Manufacturer](#) or your local distributor (see back cover).

4.2 Power ratings

4.2.1 Vacon NXI_ xxxx 5 – Supply voltage 465-800 Vdc, Motor voltage 380—500 Vac

High overload = Max current I_S ; 2 sec/20 sec, 150% overloadability; 1 min/10 min
 Following continuous operation at rated output current, 150 % rated output current (I_H) for 1 min, followed by a period of load current less than rated current, and of such duration that the r.m.s output current, over the duty cycle, does not exceed rated output current (I_H)

Low overload = Max current I_S ; 2 sec/20 sec, 110% overloadability; 1 min/10 min
 Following continuous operation at rated output current, 110% rated output current (I_L) for 1 min, followed by a period of load current less than rated current, and of such duration that the r.m.s output current, over the duty cycle, does not exceed rated output current (I_L)

Motor voltage 380-500 Vac, 50/60 Hz, 3~											
Inverter type	Loadability @ 40 °C ambient temperature					Motor shaft power				Frame	Dimensions and weight W×H×D/kg
	Low		High		Max current I_S	513Vdc supply		675Vdc supply			
	Rated continuous current I_L (A)	10% overload current (A)	Rated continuous current I_H (A)	50% overload current (A)		10% overload 40°C P(kW)	50% overload 40°C P(kW)	10% overload 40°C P(kW)	50% overload 40°C P(kW)		
NXI_0168 5	170	187	140	210	238	90	75	110	90	F19	239 × 1030 × 372/65
NXI_0205 5	205	226	170	255	285	110	90	132	110	F19	239 × 1030 × 372/65
NXI_0261 5	261	287	205	308	349	132	110	160	132	F19	239 × 1030 × 372/65
NXI_0300 5	300	330	245	368	444	160	132	200	160	F19	239 × 1030 × 372/65
NXI_0385 5	385	424	300	450	540	200	160	250	200	F110	239 × 1030 × 552/100
NXI_0460 5	460	506	385	578	693	250	200	315	250	F110	239 × 1030 × 552/100
NXI_0520 5	520	572	460	690	828	250	250	355	315	F110	239 × 1030 × 552/100
NXI_0590 5	590	649	520	780	936	315	250	400	355	F112	2×239 × 1030 × 552/200
NXI_0650 5	650	715	590	885	1062	355	315	450	400	F112	2×239 × 1030 × 552/200
NXI_0730 5	730	803	650	975	1170	400	355	500	450	F112	2×239 × 1030 × 552/200
NXI_0820 5	820	902	730	1095	1314	450	400	560	500	F112	2×239 × 1030 × 552/200
NXI_0920 5	920	1012	820	1230	1476	500	450	630	560	F112	2×239 × 1030 × 552/200
NXI_1030 5	1030	1133	920	1380	1656	560	500	710	630	F112	2×239 × 1030 × 552/200
NXI_1150 5	1150	1265	1030	1545	1854	630	560	800	710	F113	708 × 1030 × 553/302
NXI_1300 5	1300	1430	1150	1725	2070	710	630	900	800	F113	708 × 1030 × 553/302
NXI_1450 5	1450	1595	1300	1950	2340	800	710	1000	900	F113	708 × 1030 × 553/302
NXI_1770 5	1770	1947	1600	2400	2880	1000		1200		F114	2×708 × 1030 × 553/302
NXI_2150 5	2150	2365	1940	2910	3492	1200		1500		F114	2×708 × 1030 × 553/302
NXI_2700 5	2700	2970	2300	3287	3933	1500		1800		F114	2×708 × 1030 × 553/302

Table 4-1. Power ratings and dimensions of Vacon NXI, supply voltage 465—800Vdc

Note: The rated currents in given ambient temperatures are achieved only when the switching frequency is equal to or less than the factory default.

4.2.2 *Vacon NXI_xxxx 6 – Supply voltage 640–1100 Vdc, Motor voltage 525–690 Vac*

High overload = Max current I_s , 2 sec/20 sec, 150% overloadability; 1 min/10 min

Following continuous operation at rated output current, 150 % rated output current (I_H) for 1 min, followed by a period of load current less than rated current, and of such duration that the r.m.s output current, over the duty cycle, does not exceed rated output current (I_H)

Low overload = Max current I_s , 2 sec/20 sec, 110% overloadability; 1 min/10 min

Following continuous operation at rated output current, 110% rated output current (I_L) for 1 min, followed by a period of load current less than rated current, and of such duration that the r.m.s output current, over the duty cycle, does not exceed rated output current (I_L)

All frames are available as IP21 and IP54.

Motor voltage 525-690 Vac, 50/60 Hz, 3~									
Inverter type	Loadability @ 40 °C ambient temperature				Motor shaft power			Frame	Dimensions and weight WxHxD/kg
	Low		High		930Vdc supply				
	Rated continuous current I_L (A)	10% overload current (A)	Rated continuous current I_H (A)	50% overload current (A)	Max current I_s	10% overload 40°C P(kW)	50% overload 40°C P(kW)		
NXI_0125 6	125	138	100	150	200	110	90	FI9	239 x 1030 x 372/65
NxI_0144 6	144	158	125	188	213	132	110	FI9	239 x 1030 x 372/65
NxI_0170 6	170	187	144	216	245	160	132	FI9	239 x 1030 x 372/65
NXI_0208 6	208	229	170	255	289	200	160	FI9	239 x 1030 x 372/65
NXI_0261 6	261	287	208	312	375	250	200	FI10	239 x 1030 x 552/100
NXI_0325 6	325	358	261	392	470	315	250	FI10	239 x 1030 x 552/100
NXI_0385 6	385	424	325	488	585	355	315	FI10	239 x 1030 x 552/100
NXI_0416 6	416	458	325	488	585	400	355	FI10	239 x 1030 x 552/100
NXI_0460 6	460	506	385	578	693	450	400	FI12	2x239 x 1030 x 552/200
NXI_0502 6	502	552	460	690	828	500	450	FI12	2x239 x 1030 x 552/200
NXI_0590 6	590	649	502	753	904	560	500	FI12	2x239 x 1030 x 552/200
NXI_0650 6	650	715	590	885	1062	630	560	FI12	2x239 x 1030 x 552/200
NXI_0750 6	750	825	650	975	1170	710	630	FI12	2x239 x 1030 x 552/200
NXI_0820 6	820	902	650	975	1170	800	710	FI12	2x239 x 1030 x 552/200
NXI_0920 6	920	1012	820	1230	1476	900	800	FI13	708 x 1030 x 553/302
NXI_1030 6	1030	1133	920	1380	1656	1000	900	FI13	708 x 1030 x 553/302
NXI_1180 6	1180	1298	1030	1464	1755	1200	1000	FI13	708 x 1030 x 553/302
NXI_1500 6	1500	1650	1300	1950	2340	1500	1300	FI14	2x708 x 1030 x 553/302
NXI_1900 6	1900	2090	1500	2250	2700	1800	1500	FI14	2x708 x 1030 x 553/302
NXI_2250 6	2250	2475	1900	2782	3335	2000	1800	FI14	2x708 x 1030 x 553/302

Table 4-2. Power ratings and dimensions of Vacon NXI, supply voltage 640–1100Vdc

Note: The rated currents in given ambient temperatures are achieved only when the switching frequency is equal to or less than the factory default.

4.3 Technical information

Supply connection	Input voltage U_{in}	465...800Vdc (380-500 Vac) 640...1100Vdc (525-690 Vac) The waviness of the inverter supply voltage, which is formed in rectification of the electric network's alternating voltage in basic frequency, must be less than 50V peak-to-peak.
	Input current I_{in}	$(\sqrt{3} \times U_{mot} \times I_{mot} \times \cos\phi) / (U_{in} \times 0,98)$
	DC bank capacitance	FI9_5 : 4950 μ F; FI9_6 : 3733 μ F FI10_5: 9900 μ F; FI10_6: 7467 μ F FI12_5: 19800 μ F; FI12_6: 14933 μ F FI13_5: 29700 μ F; FI13_6: 22400 μ F
	Starting delay	5 s (FI9 and greater)
Motor connection	Output voltage	$3 \sim 0 - U_{in} / 1,4$
	Continuous output current	I_H : Ambient temperature max. +40°C, overload $1.5 \times I_H$ (1 min./10 min.) I_L : Ambient temperature max. +40°C, overload $1.1 \times I_L$ (1 min./10 min.)
	Starting torque	I_s for two seconds, torque motor dependent
	Peak current	I_s for 2 s every 20 s
	Output frequency	0...320 Hz ; 7200 Hz (Special)
	Frequency resolution	Application dependent
Control characteristics	Control method	Frequency control U/f Open Loop Sensorless Vector Control Closed Loop Frequency Control Closed Loop Vector Control
	Switching frequency (see parameter 2.6.9)	NXI_5: 1...10 kHz; Factory default 3.6 kHz NXI_6: 1...6 kHz; Factory default 1.5 kHz
	Frequency reference	
	Analogue input	Resolution 0.1% (10-bit), accuracy $\pm 1\%$
	Panel reference	Resolution 0.01 Hz
	Field weakening point	30...320 Hz
	Acceleration time	0...3000 sec
	Deceleration time	0...3000 sec
Ambient conditions	Braking torque	DC brake: $30\% * T_N$ (without brake)
	Ambient operating temperature	-10°C (no frost)...+40°C
	Storage temperature	-40°C...+70°C
	Relative humidity	0 to 95% RH, non-condensing, non-corrosive, no dripping water
	Air quality: - chemical vapours - mechanical particles	IEC 721-3-3, unit in operation, class 3C2 IEC 721-3-3, unit in operation, class 3S2
Altitude	100% load capacity (no derating) up to 1,000 m 1-% derating for each 100m above 1000.; max. 2000m	

(Continues on next page)

	Vibration EN50178/EN60068-2-6	Displacement amplitude 0.25 mm (peak) at 5...31 Hz Max acceleration 1 G at 31...150 Hz
	Shock EN50178, EN60068-2-27	UPS Drop Test (for applicable UPS weights) Storage and shipping: max 15 G, 11 ms (in package)
	Heat loss	$P_{loss}[\text{kW}] \text{ approx. } P_{mot}[\text{kW}] \times 0,02$
	Cooling air required	F19 1150 m ³ /h, F110 1400 m ³ /h, F112 2800 m ³ /h, F113 4200 m ³ /h, F114 2x4200 m ³ /h
	Unit enclosure class	IP00
EMC (at default settings)	Immunity	Fulfil all EMC immunity requirements, Level T
Safety		CE, UL, CUL EN 61800-5-1 (2003); (see unit nameplate for more detailed approvals)
Control connections	Analogue input voltage	0...+10V, $R_i = 200\text{k}\Omega$, (-10V...+10V joystick control) Resolution 0.1%, accuracy $\pm 1\%$
	Analogue input current	0(4)...20 mA, $R_i = 250\Omega$ differential
	Digital inputs (6)	Positive or negative logic; 18...30VDC
	Auxiliary voltage	+24V, $\pm 15\%$, max. 250mA
	Output reference voltage	+10V, +3%, max. load 10mA
	Analogue output	0(4)...20mA; R_L max. 500 Ω ; Resolution 10 bit; Accuracy $\pm 2\%$
	Digital outputs	Open collector output, 50mA/48V
Protections	Relay outputs	2 programmable change-over relay outputs Switching capacity: 24VDC/8A, 250VAC/8A, 125VDC/0.4A Min.switching load: 5V/10mA
	Overvoltage protection	NX_5: 911VDC; NX_6: 1200VDC
	Undervoltage protection	NX_5: 333VDC; NX_6: 460 VDC
	Earth fault protection	In case of earth fault in motor or motor cable, only the inverter is protected
	Motor phase supervision	Trips if any of the output phases is missing
	Overcurrent protection	Yes
	Unit overtemperature protection	Yes
	Motor overload protection	Yes
Motor stall protection	Yes	
Motor underload protection	Yes	
Short-circuit protection of +24V and +10V reference voltages	Yes	

Table 4-3. Technical information

Structure	I _N (output)	Motor P.F.	I _{DC} (input)
FI9	261	0,89	304
	300	0,89	350
FI10	385	0,9	454
	460	0,9	542
	520	0,9	613
FI12	590	0,9	695
	650	0,9	766
	730	0,91	870
	820	0,91	977
	920	0,91	1096
	1030	0,91	1227
FI13	1150	0,91	1370
	1300	0,91	1549
	1450	0,91	1727
FI14	1770	0,92	2132
	2150	0,92	2590
	2700	0,92	3252

Table 4- 4 DC currents and dimensions of Vacon NXI, supply voltage 465 - 800Vdc

Structure	I _N (output)	Motor P.F.	I _{DC} (input)
FI9	125	0,89	146
	144	0,89	168
	170	0,89	198
	208	0,9	245
FI10	261	0,9	308
	325	0,9	383
	385	0,9	454
	416	0,9	490
FI12	460	0,91	548
	502	0,91	598
	590	0,91	703
	650	0,91	774
	750	0,91	894
	820	0,91	977
FI13	920	0,91	1096
	1030	0,91	1227
	1180	0,92	1421
FI14	1500	0,92	1807
	1900	0,93	2313
	2250	0,93	2739

Table 4- 5. DC currents and dimensions of Vacon NXI, supply voltage 640 - 1100Vdc

5. INSTALLATION

5.1 Mounting

The inverter can be mounted in a vertical position on the back plane of a cubicle. Enough space must be reserved around the inverter to ensure sufficient cooling, see Figure 5-7. Follow the minimum dimensions for installation, see Table 5-1 and Table 5-2. Also make sure that the mounting plane is relatively even. The inverter is fixed with four screws (or bolts, depending on the unit size). The dimensions for installation are presented in Figure 5-7 and Table 5-1. The following pages show the dimensions for IP00 power module.

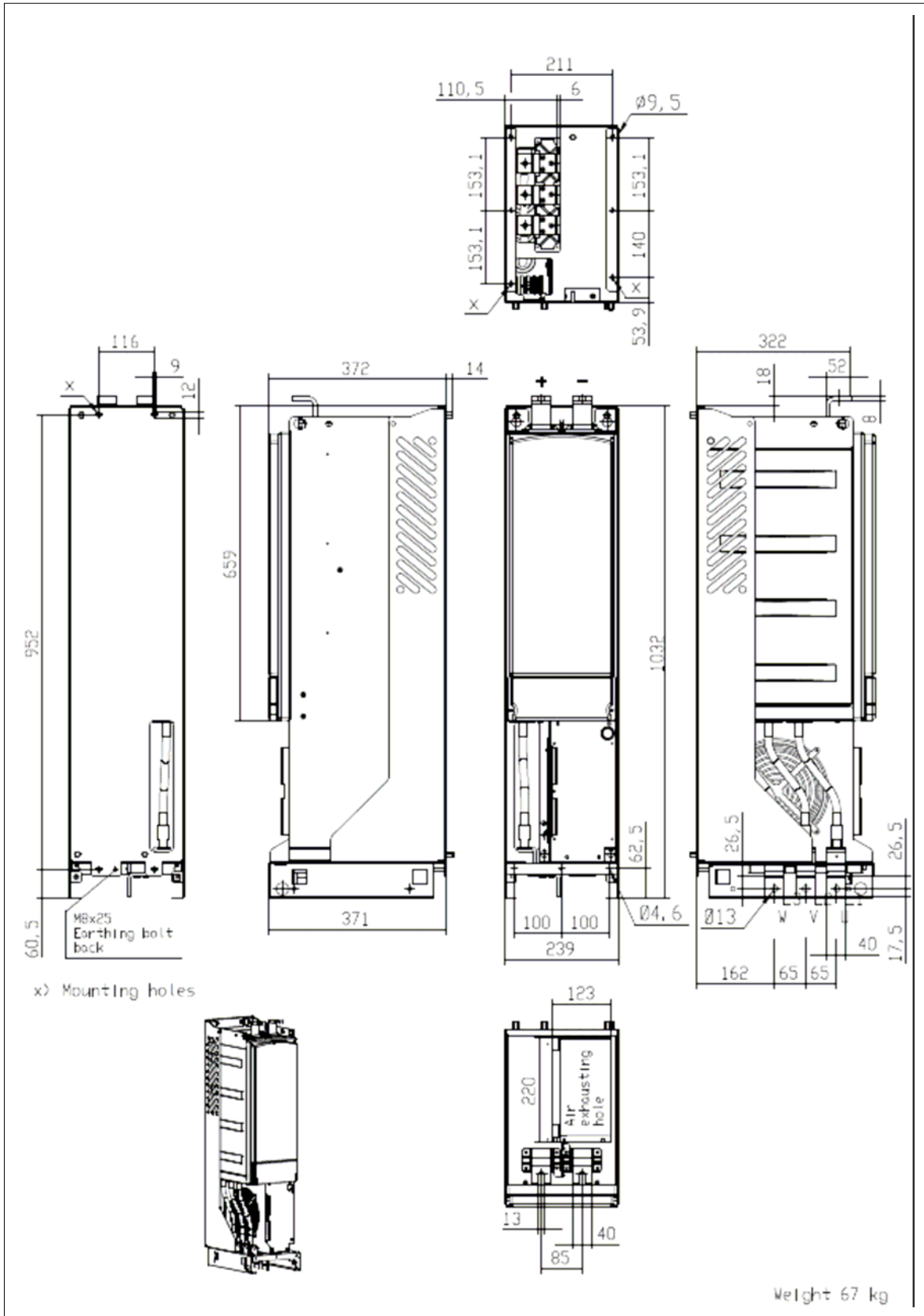

Figure 5-1. The dimensions of Vacon NXI F19

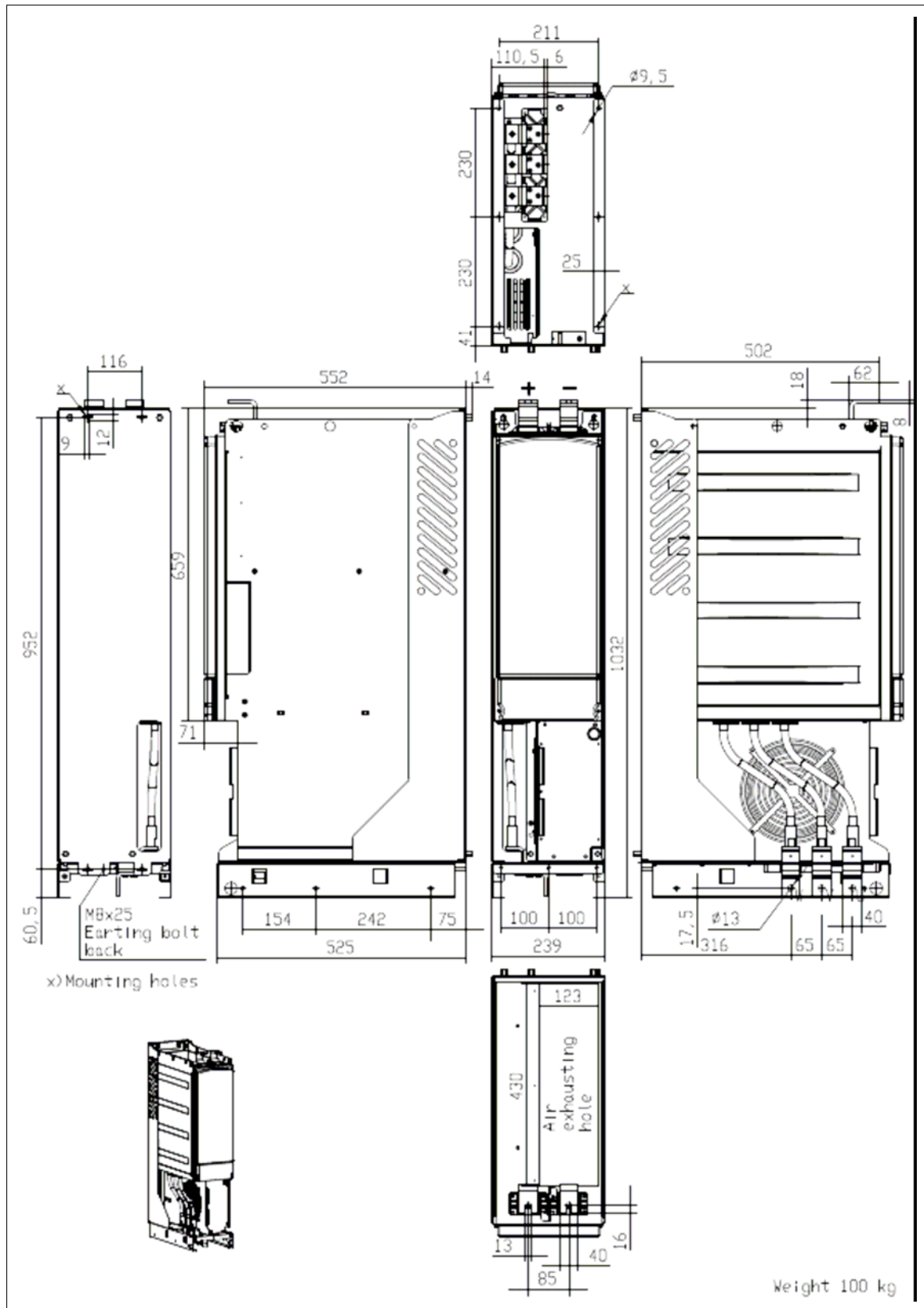

Figure 5-2. Vacon NXI dimensions, F110

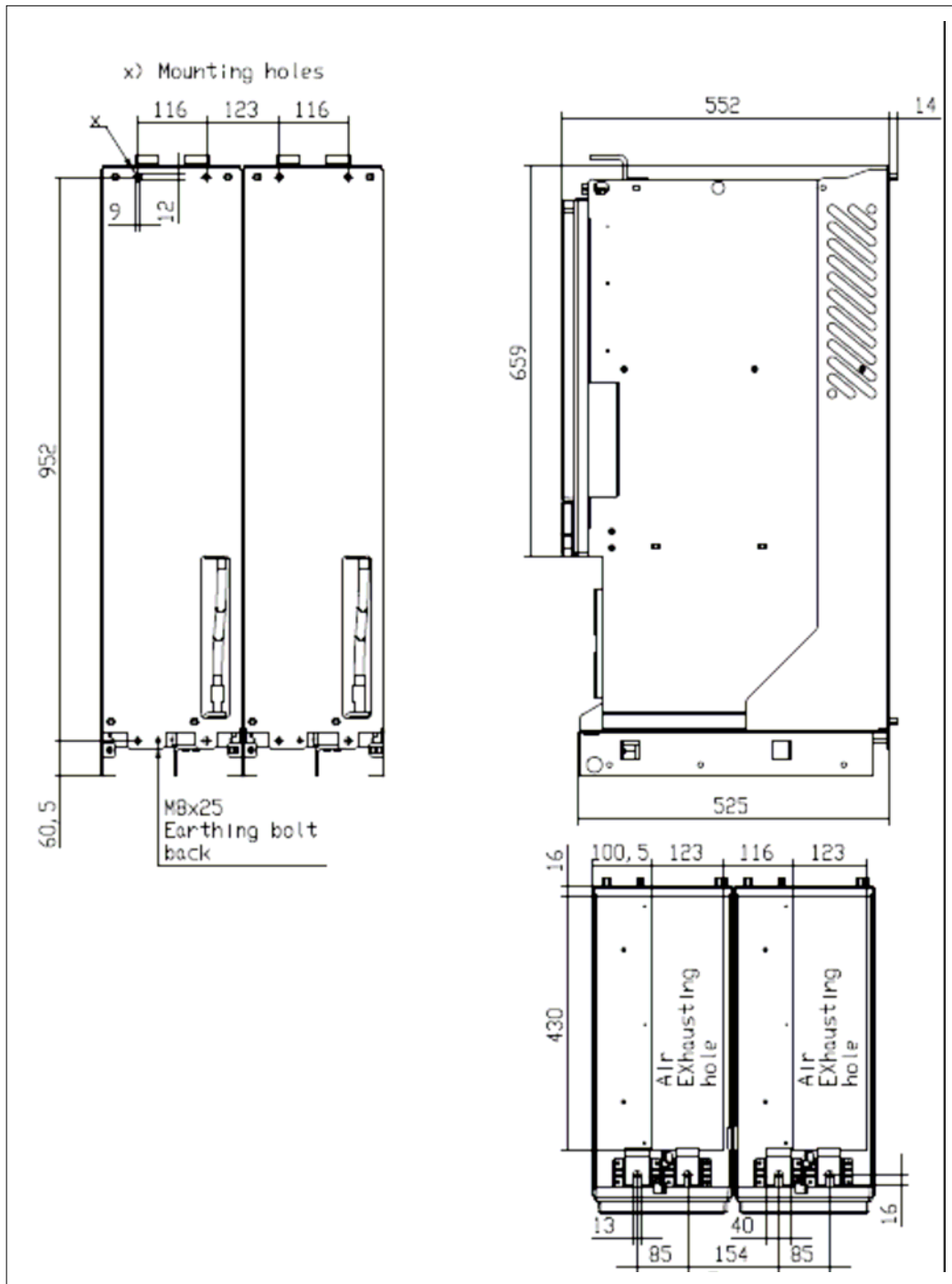

Figure 5-3. Vacon NXI dimensions, F112 back view.

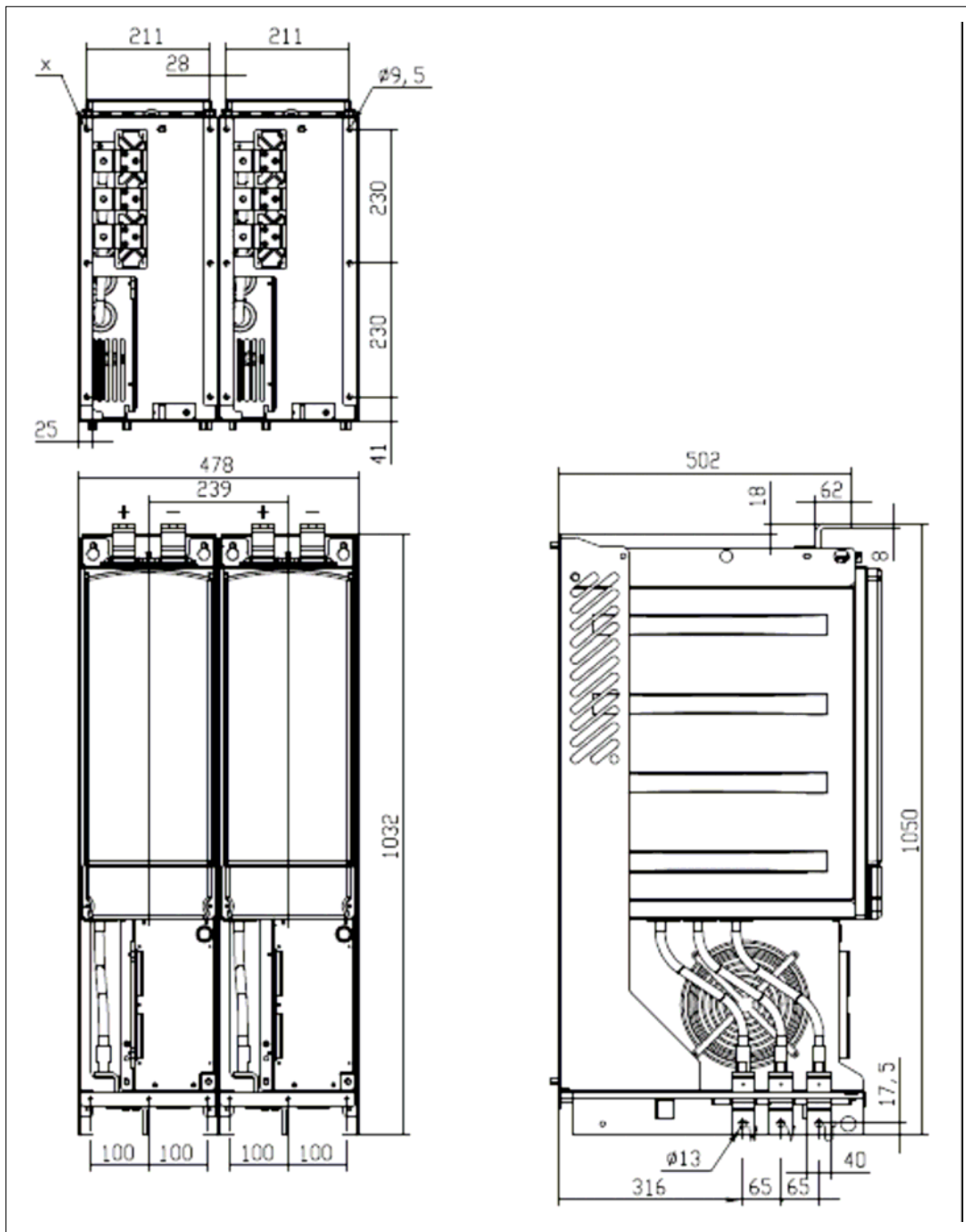

Figure 5-4. Vacon NXI dimensions, F112 front view

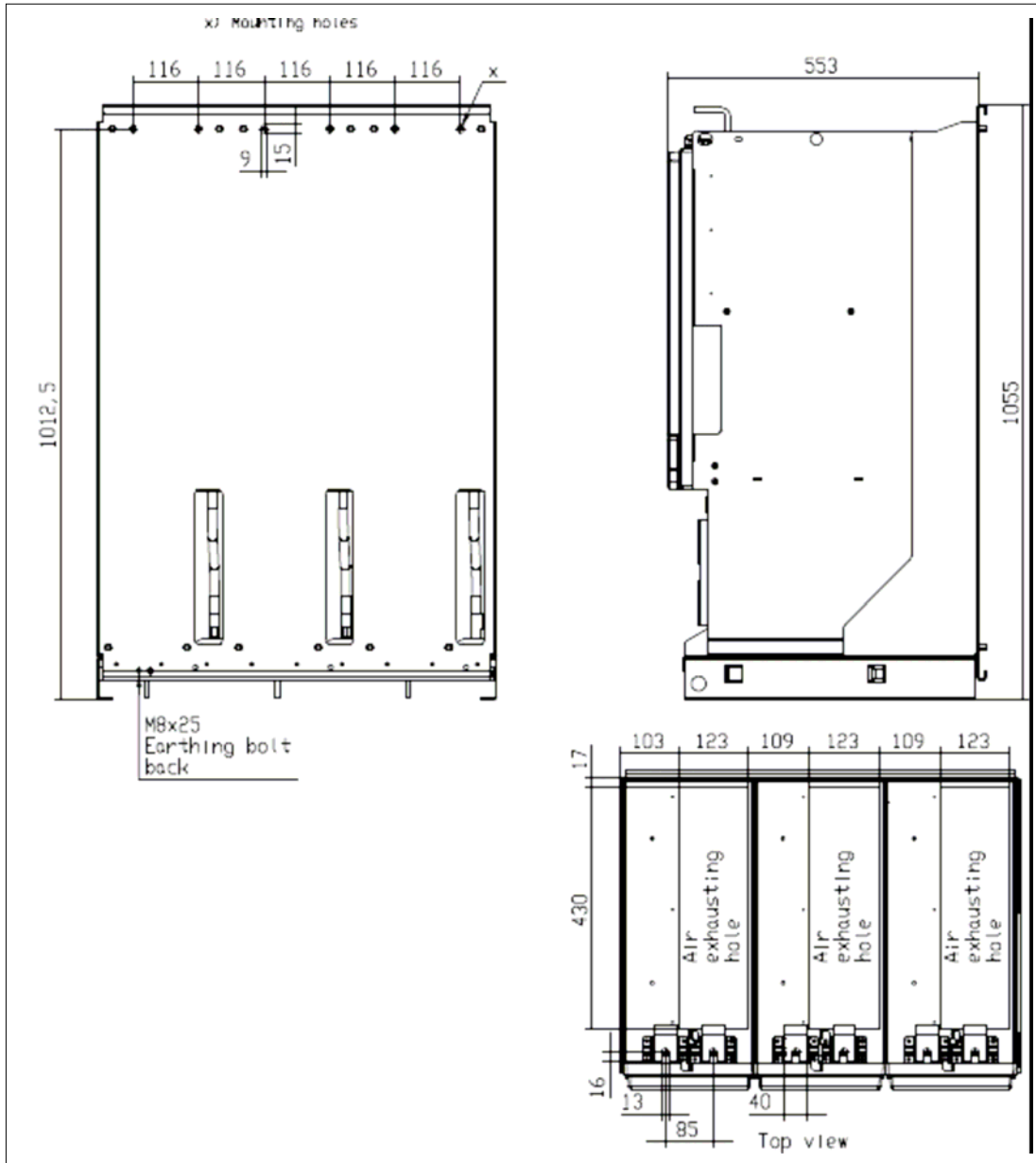

Figure 5-5. Vacon NXI dimensions, F113 back view. Note, F114 is a double F113

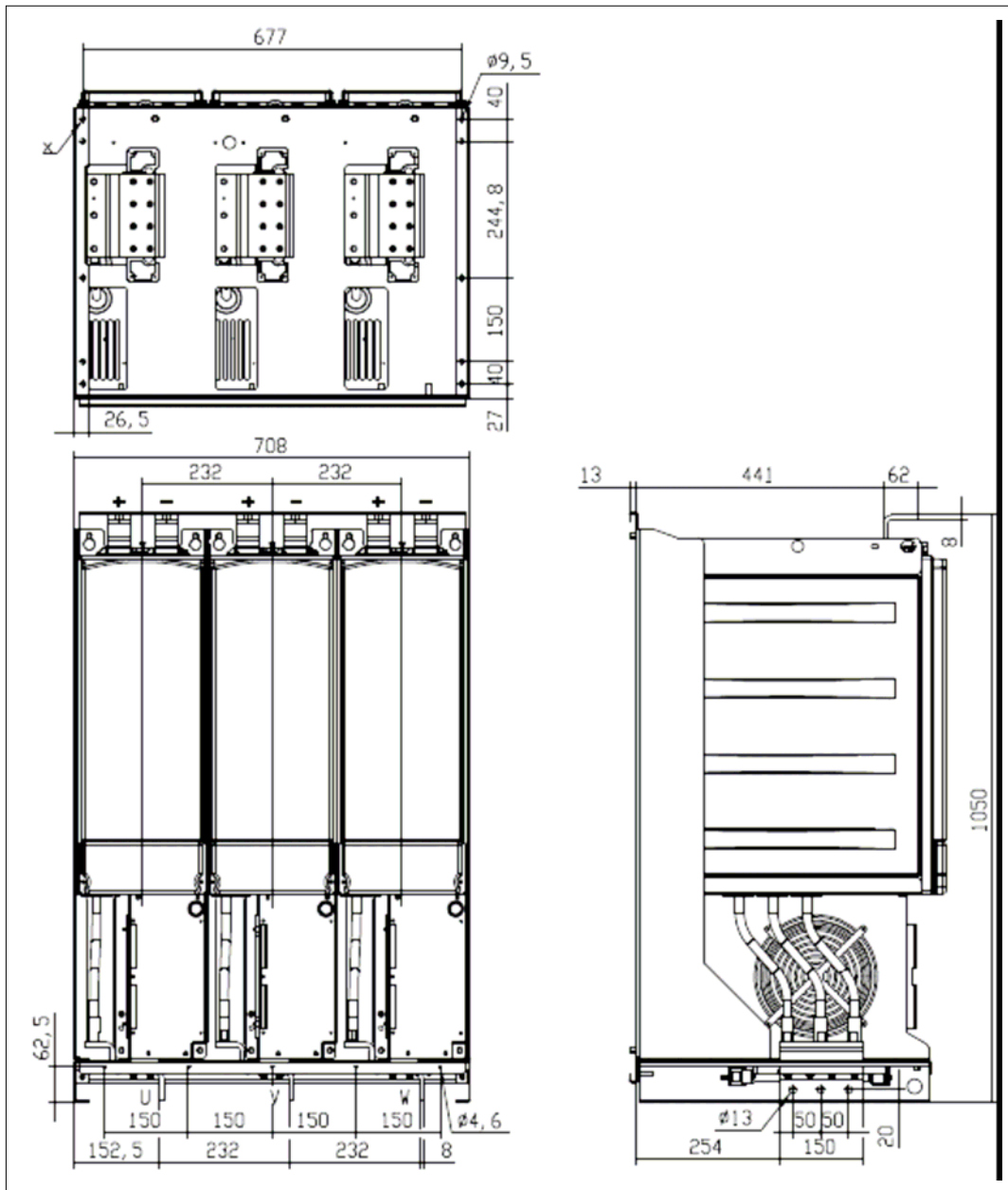

Figure 5-6. Vacon NXI dimensions, F113 front view. Note, F114 is a double F113

5.2 Fan cooling

5.2.1 Frames F19 to F114

Enough free space must be left around the inverter to ensure sufficient air circulation and cooling. You will find the required dimensions for free space in the table below.

If several units are mounted on top of each other, the required free space equals $2 * C$ (see figure below). Moreover, the outlet air used for cooling by the lower unit must be directed away from the air intake of the upper unit. When planning the cooling for the space, take into consideration that the inverter's heat loss is approx. 2.5% of the nominal capacity.

Type	Dimensions [mm]			
	A	B	B ₂	C
NXI_0168 – 0300 5 NXI_0125 – 0208 6	200	20		Min. 300
NXI_0385 – 0520 5 NXI_0261 – 0416 6	200	20		Min. 300
NXI_0590 – 1030 5 NXI_0460 – 0820 6	200	20	0	Min. 300
NXI_1150 – 1450 5 NXI_0920 – 1180 6	200	20	0	Min. 300
NXI_1770 – 2700 5 NXI_1500 – 2250 6	The dimensions as per F113 module			

Table 5-1. Mounting space dimensions

- A = free space above the inverter
- B = distance between inverter and cabinet wall
- B₂ = distance between two inverters
- C = free space underneath of the inverter

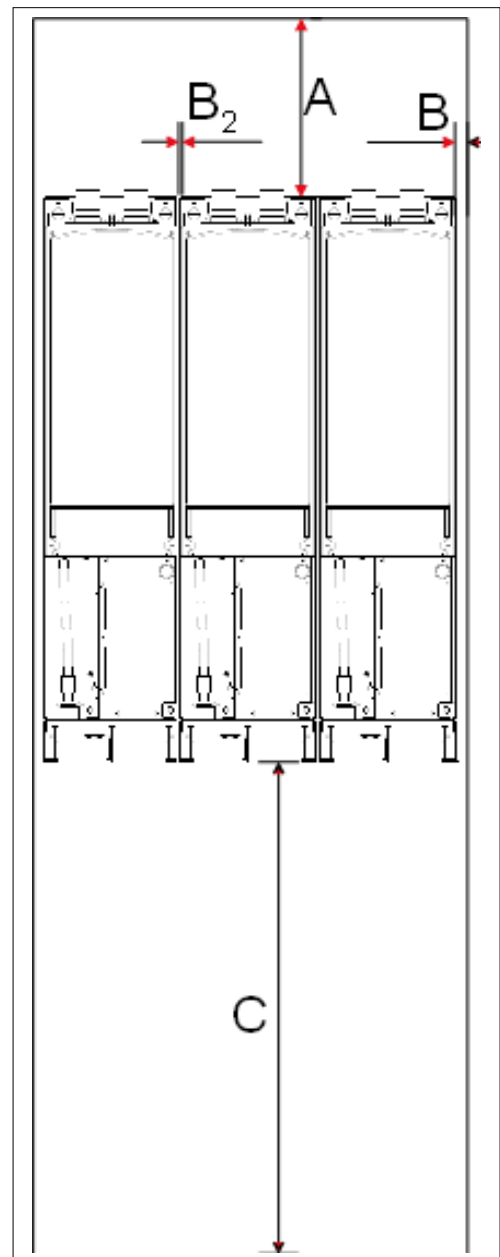

Figure 5-7. Installation space.

Type	Frame	Cooling air required (m ³ /h)	Minimum air holes on switchgear (mm ²)
NXI_0168 – 0300 5 NXI_0125 – 0208 6	FI9	1.150	Inlet: 55.000 Outlet: 30.000
NXI_0385 – 0520 5 NXI_0261 – 0416 6	FI10	1.400	Inlet: 65.000 Outlet: 40.000
NXI_0590 – 1030 5 NXI_0460 – 0820 6	FI12	2.800	Inlet: 130.000 Outlet: 70.000
NXI_1150 – 1450 5 NXI_0920 – 1180 6	FI13	4.200	Inlet: 195.000 Outlet: 105.000
NXI_1770 – 2700 5 NXI_1500 – 2250 6	FI14	2 × 4.200	Inlet: 2 × 195.000 Outlet: 2 × 105.000

Table 5-2. Required cooling air

5.2.2 Arranging ventilation of the enclosure

The enclosure door must be provided with air gaps for air intake. To achieve sufficient cooling inside the cabinet, the dimensions for the **total area of free openings for incoming air** given in Table 5-2 must be followed. For instance, there could be two screened gaps as presented in Figure 5-7 (Vacon's recommendation). This layout ensures a sufficient air flow to the module fans as well as cooling of the additional components.

Air outlet gaps must be situated on top of the cabinet. The minimum effective air outlet area per converter frame is given in Table 5-2. The cooling arrangements inside the cabinet must be such that they prevent hot output air from mixing with the incoming fresh air (see page 32).

The ventilation gaps must fulfil the requirements set by the selected IP class. The examples in this manual apply to protection class IP21.

During operation, air is sucked in and circulated by a fan blower at the bottom of the power unit. If the power unit is placed in the upper part of the cabinet, the fan blower will be in the mid of the cabinet, at the height of the upper ventilation grid.

See Figure 5-7 on page 29.

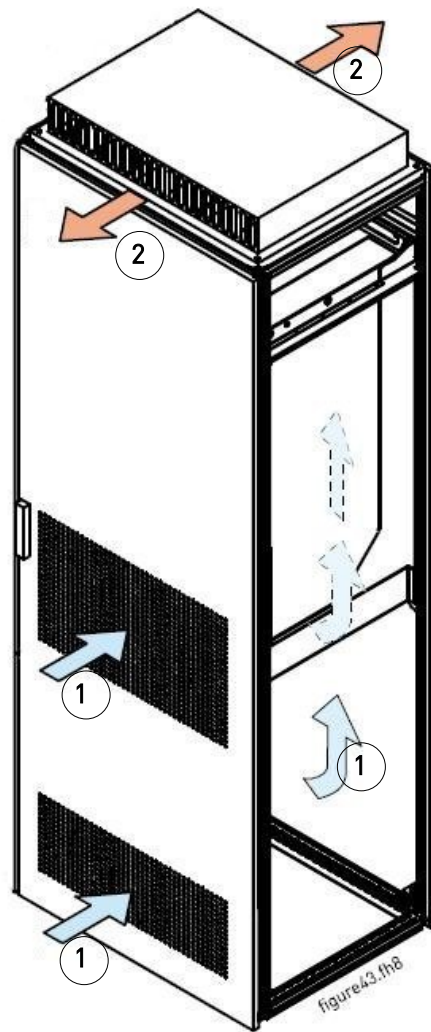

Figure 5-8. Cabinet openings for cooling.
1. Cooling air inlets
2. Hot air exhaust

STEERING AIR FLOW

Cooling air must be taken in through the ventilation gaps on the door and blown out at the top of the enclosure. To steer the hot air from the power unit to the outlet at the top of the enclosure and prevent it from circulating back to the fan blower, use either of the following arrangements:

- A. Install a closed air duct from the power unit to the outlet on top of the enclosure (A in figures below).
- B. Install shields in the gaps between the power unit and the cabinet walls (B in figures below). Place the shields above the air outlet gaps at the sides of the module.

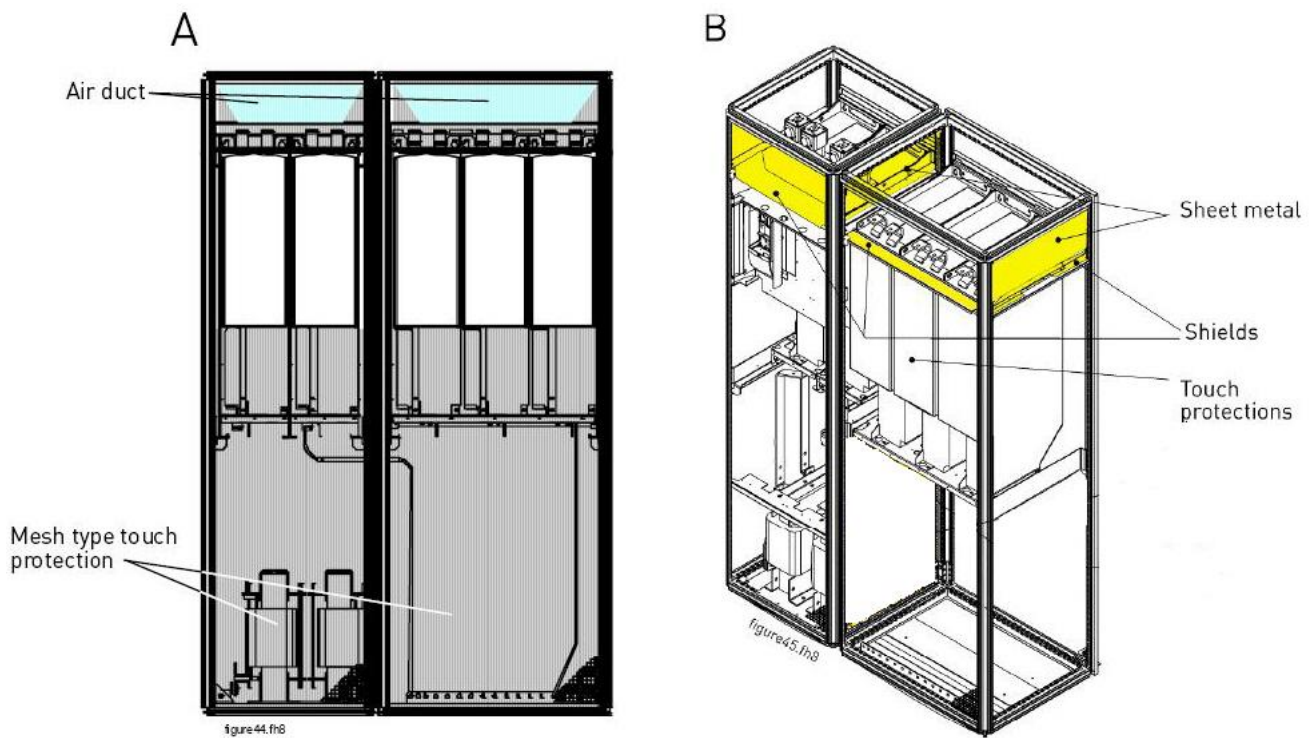

Figure 5-9. Cabinet cooling airflow guides

6. CABLING AND CONNECTIONS

6.1 Power unit

The following wiring diagrams show the supply and motor connections.

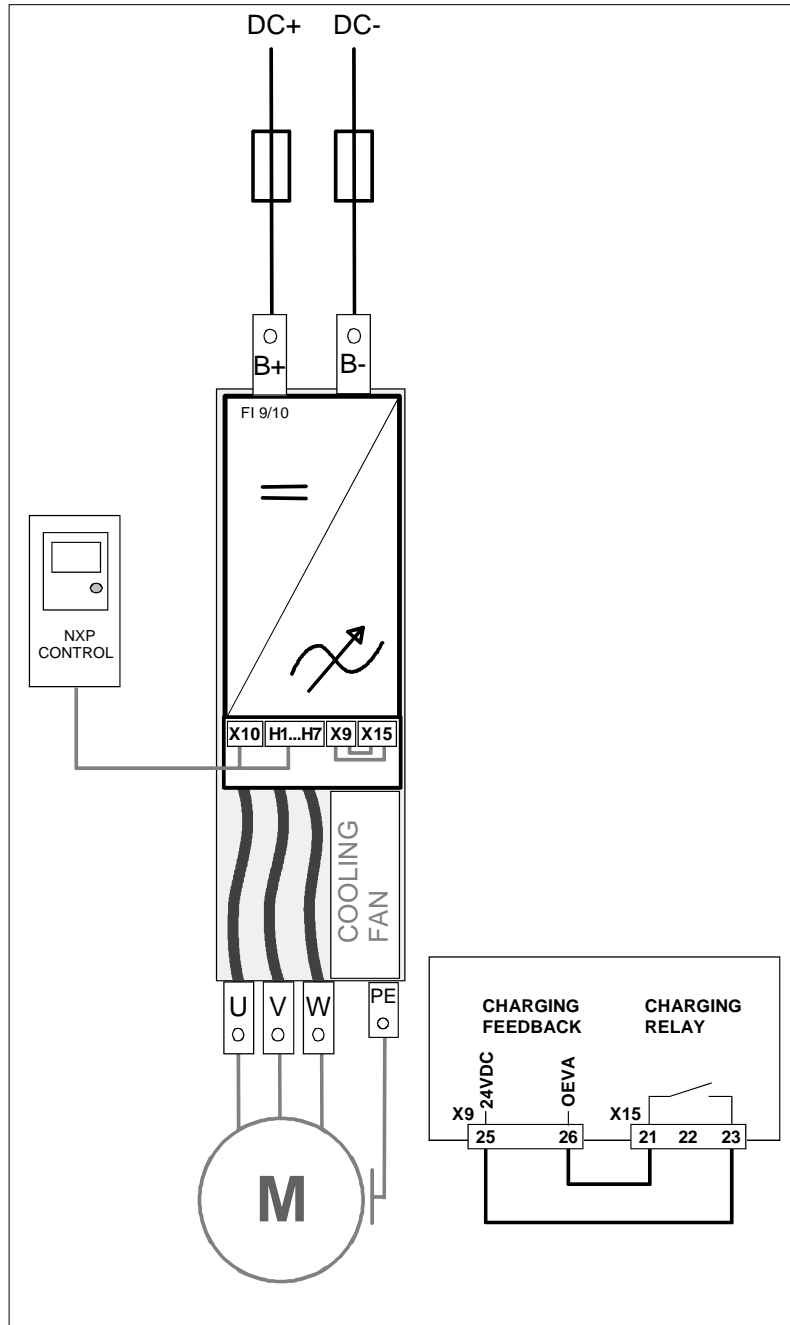

Figure 6-1. FI9/10 basic wiring diagram without charging

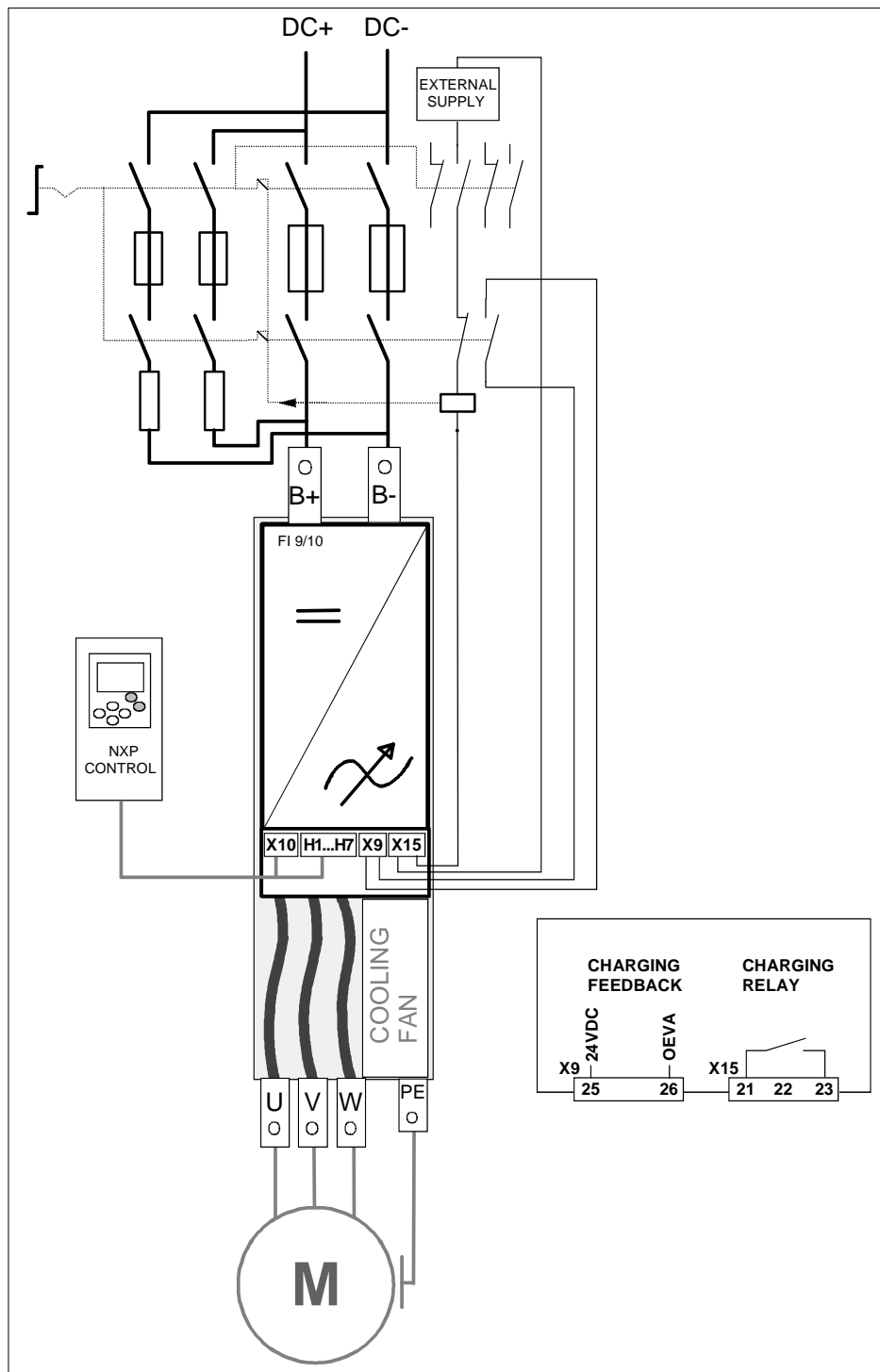

Figure 6-2, FI9/10 basic wiring diagram with charging

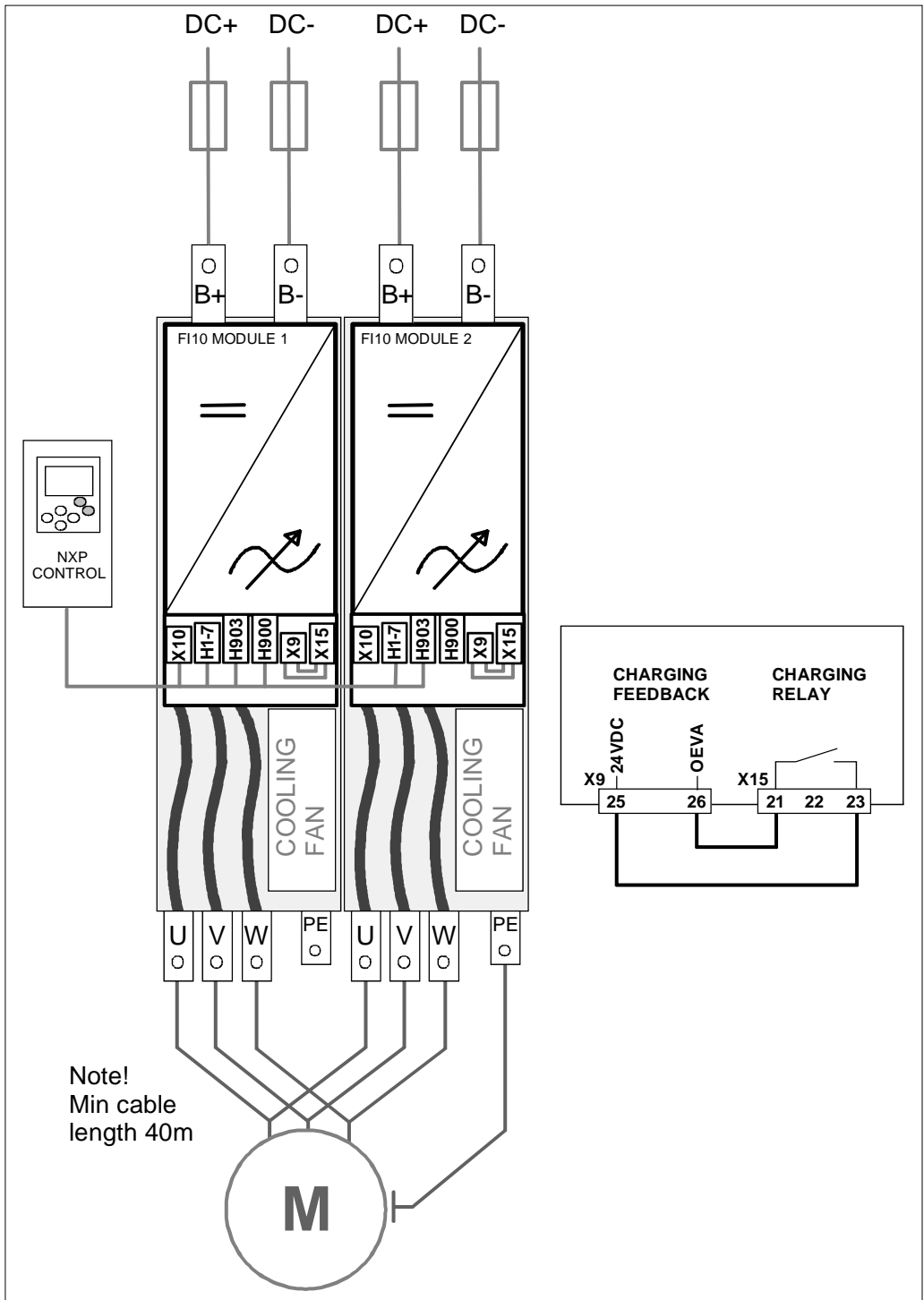

Figure 6-3, F112 basic wiring diagram without charging

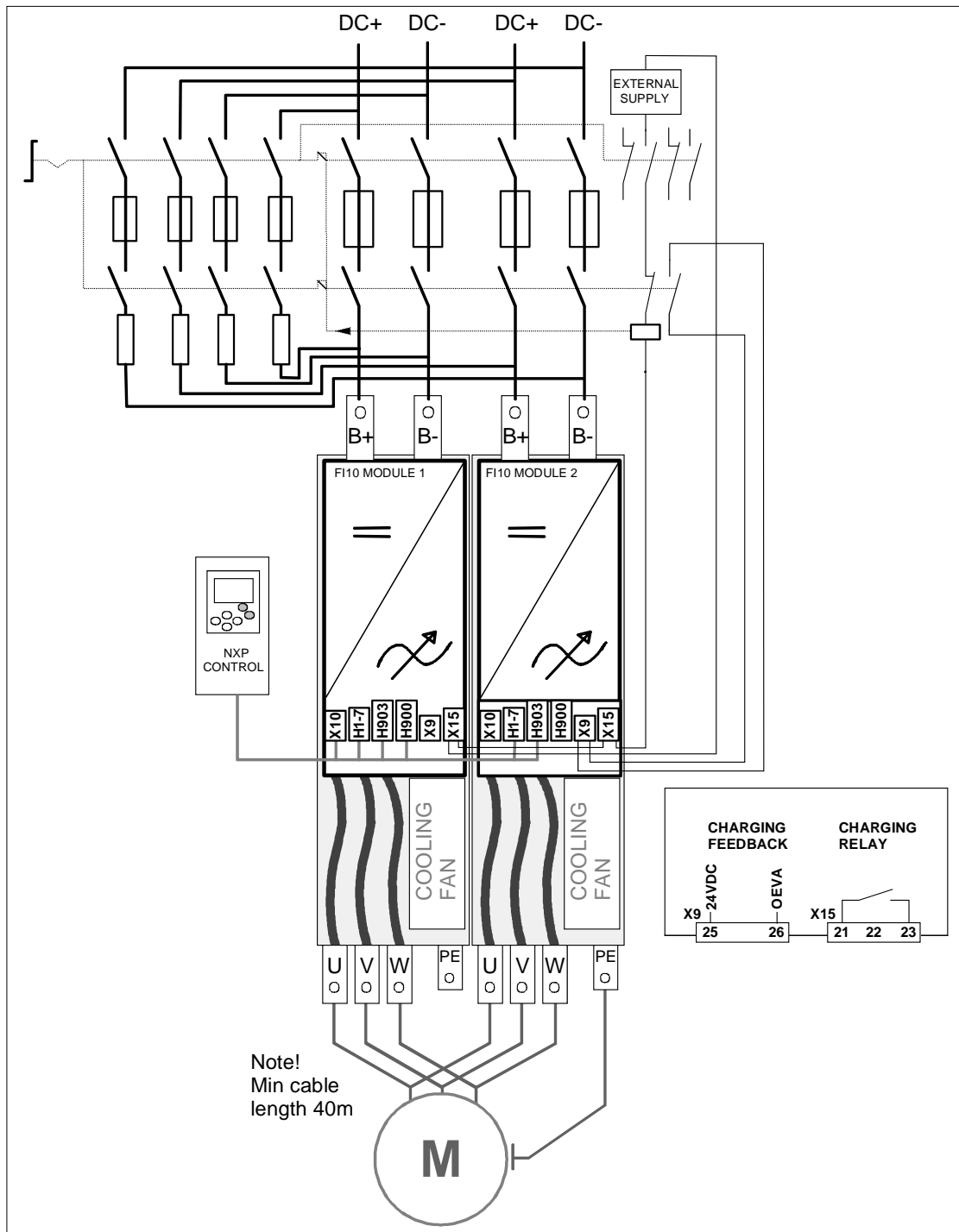

Figure 6-4, F112 basic wiring diagram with charging

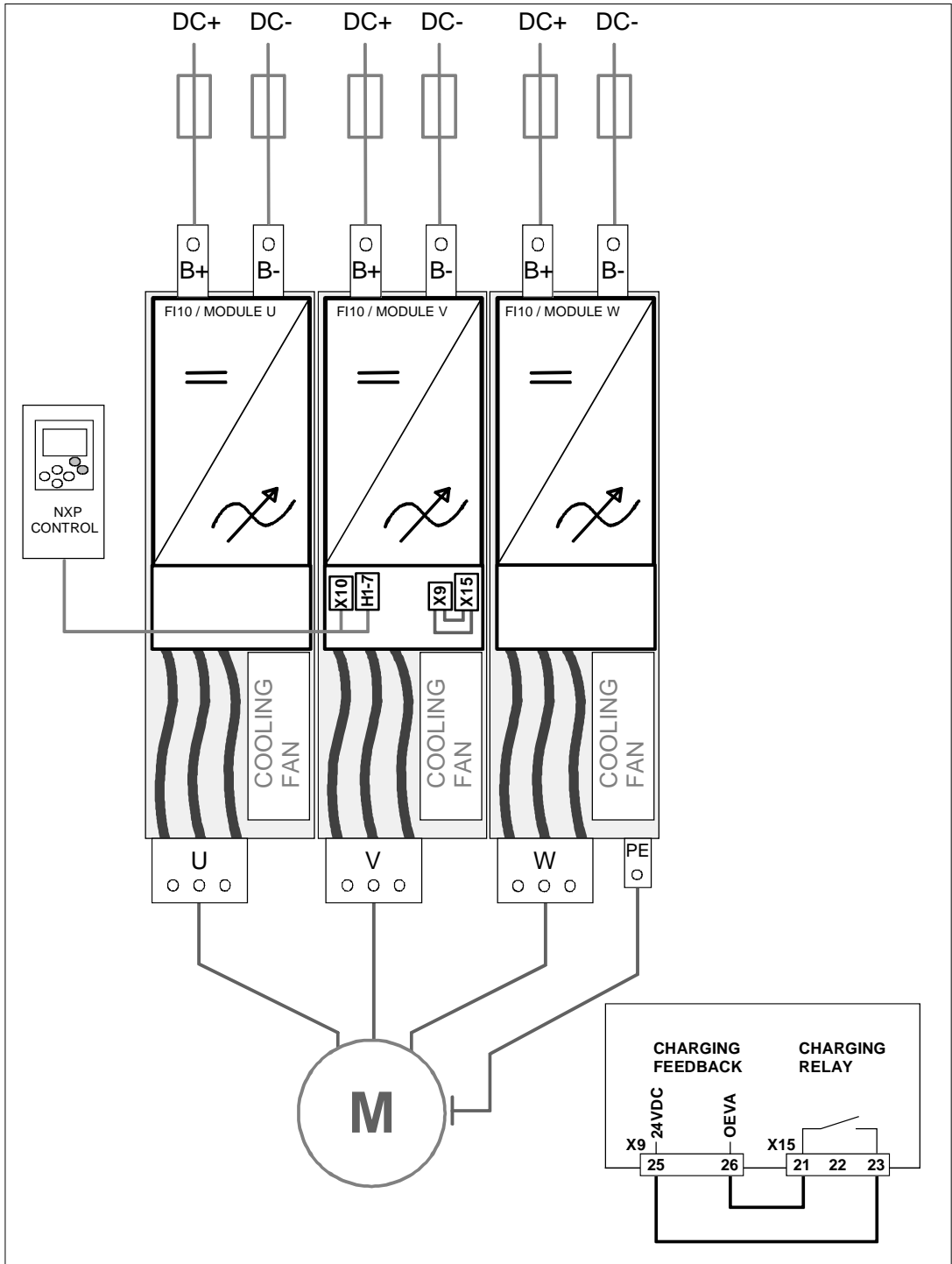

Figure 6-5, F113 basic wiring diagram without charging

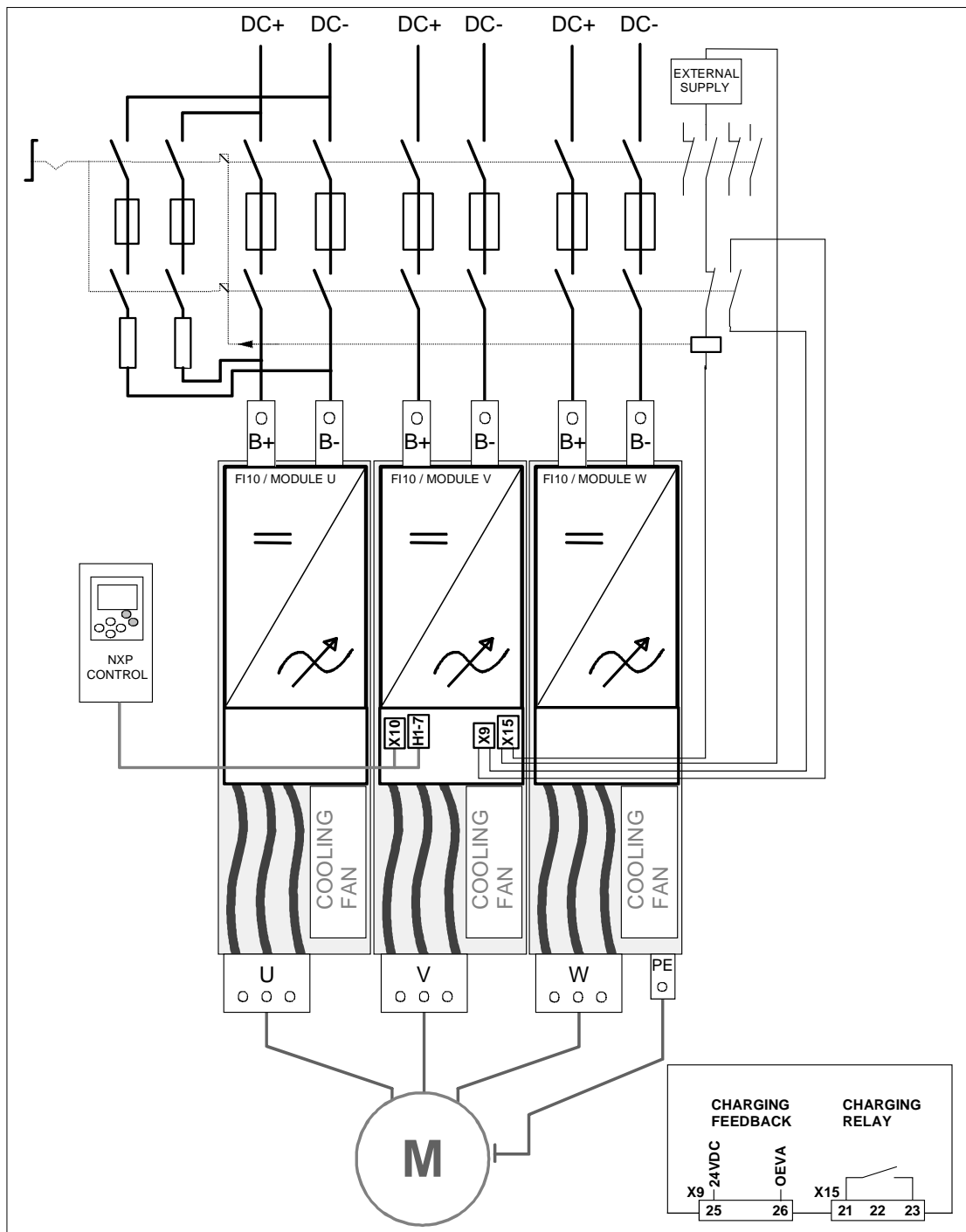

Figure 6-6. F113 basic wiring diagram with charging

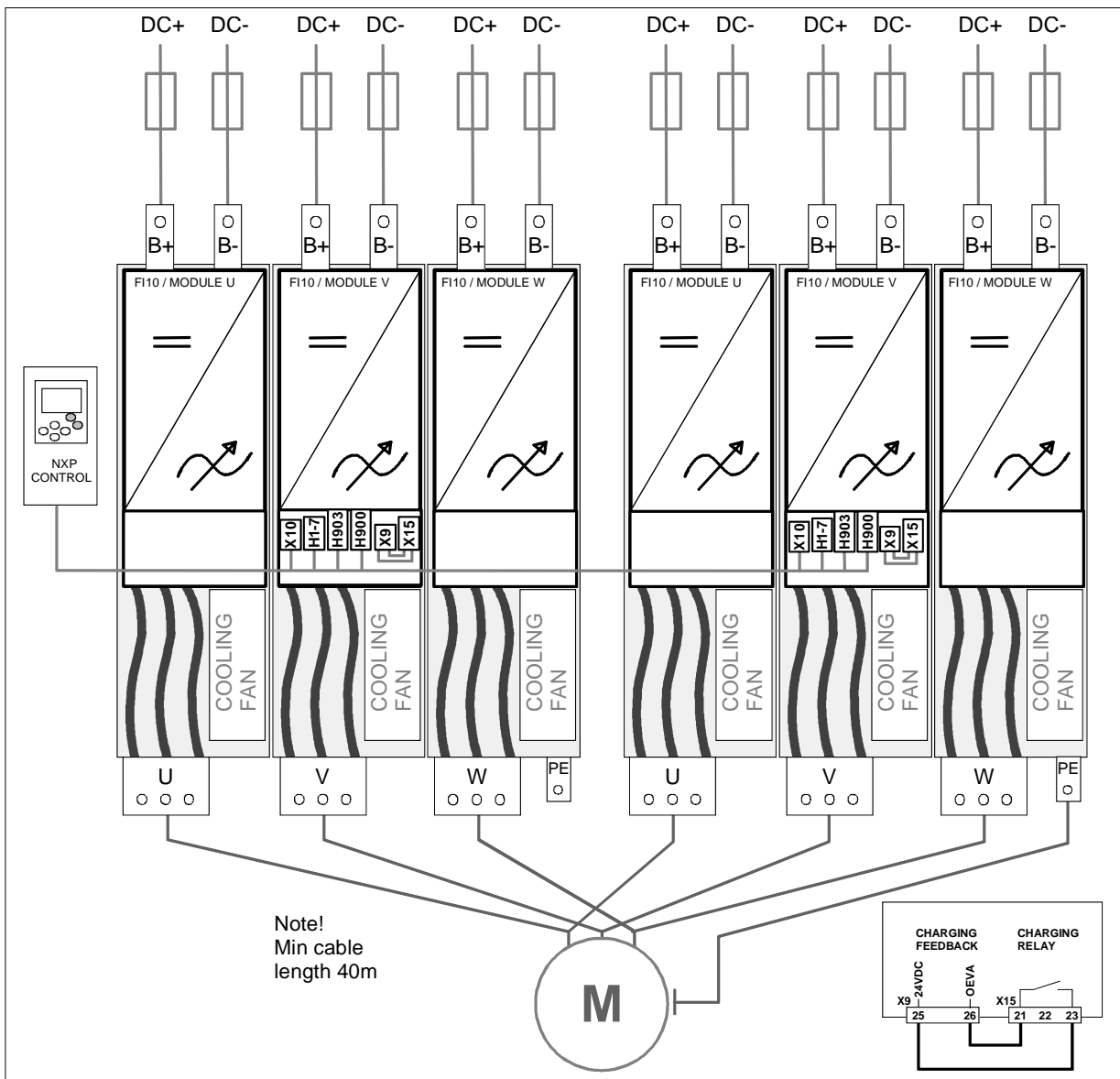

Figure 6-7. F114 basic wiring diagram without charging

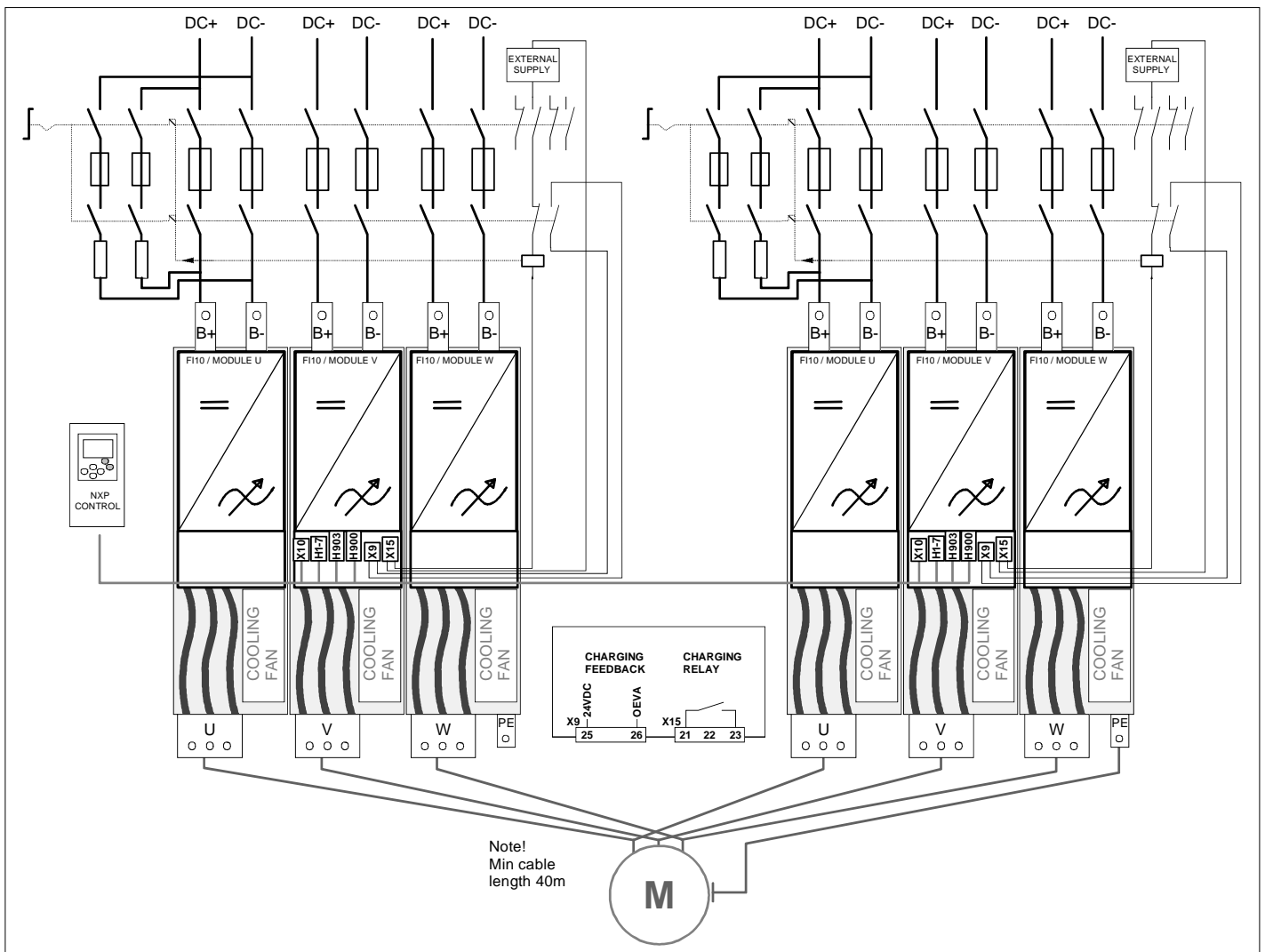

Figure 6-8. F114 basic wiring diagram with charging

6.1.1 Power connections

6.1.1.1 DC supply and motor cables

The power supply is connected to terminals **B+** and **B-** and the motor cables to terminals **U/T1**, **V/T2** and **W/T3**. A cable entry gland should be used at the motor cable end to reach the EMC levels, see Table 6-1.

Use cables with a heat resistance of at least +70°C. The cables and the fuses must be sized according to the inverter nominal output current which can be found on the rating plate. Installation of cables according to UL regulations is presented in Chapter 6.1.3 and aR fuse sizes in Tables 6-2 and 6-3.

If the motor temperature protection of the drive (see Vacon All in One Application Manual) is used as an overload protection, the cable shall be chosen accordingly.

These instructions apply only to installations with one motor and one cable connection from the inverter to the motor. In any other case, ask the factory for more information.

Cable type	EMC Level T
Power supply	Flexible conductor. Min. temperature endurance for isolation 70°C Copper Busbar
Motor cable	Power cable equipped with concentric protection wire and intended for the specific mains voltage. (PIRELLI/MCMK or similar recommended).
Control cable	Screened cable equipped with compact low-impedance shield (PIRELLI/jamak, SAB/ÖZCuY-0 or similar).

Table 6-1. Cable types required to meet standards

6.1.1.2 Control cable

For information on control cables, see Chapter 6.2.1.1 and Table 6-1 above.

6.1.1.3 Fuses, NXI xxxx 5

Type	Frame	I _L [A]	Bussman aR fuse type	Fuse size	Fuse U _n [V]	Fuse I _n [A]	No. of fuses
NXI_0168 5	FI9	168	170M3819	DIN1	690	400	2
NXI_0205 5		205	170M3819	DIN1	690	400	2
NXI_0261 5		261	170M6812	DIN3	690	800	2
NXI_0300 5		300	170M6812	DIN3	690	800	2
NXI_0385 5	FI10	385	170M8547	3SHT	690	1250	2
NXI_0460 5		460	170M8547	3SHT	690	1250	2
NXI_0520 5		520	170M8547	3SHT	690	1250	2
NXI_0590 5	FI12	590	170M8547	3SHT	690	1250	2 × 2
NXI_0650 5		650	170M8547	3SHT	690	1250	2 × 2
NXI_0730 5		730	170M8547	3SHT	690	1250	2 × 2
NXI_0820 5		820	170M8547	3SHT	690	1250	2 × 2
NXI_0920 5		920	170M8547	3SHT	690	1250	2 × 2
NXI_1030 5		1030	170M8547	3SHT	690	1250	2 × 2
NXI_1150 5	FI13	1150	170M8547	3SHT	690	1250	6

NXI_1300 5	F114	1300	170M8547	3SHT	690	1250	6
NXI_1450 5		1450	170M8547	3SHT	690	1250	6
NXI_1770 5		1770	170M8547	3SHT	690	1250	2 × 6
NXI_2150 5		2150	170M8547	3SHT	690	1250	2 × 6
NXI_2700 5		2700	170M8547	3SHT	690	1250	2 × 6

Table 6-2. Fuses used in Vacon NXI (465 - 800Vdc)

6.1.1.4 Fuses, NXI xxxx 6

Type	Frame	IL [A]	Bussman aR fuse type	Fuse size	Fuse Un [V]	Fuse In [A]	No. of fuses
NXI_0125 6	FI9	125	170M4199	1SHT	1250	400	2
NXI_0144 6		144	170M4199	3SHT	1250	400	2
NXI_0170 6		170	170M4199	3SHT	1250	400	2
NXI_0208 6		208	170M4199	3SHT	1250	400	2
NXI_0261 6	FI10	261	170M6305	3SHT	1250	700	2
NXI_0325 6		325	170M6305	3SHT	1250	700	2
NXI_0385 6		385	170M6277	3SHT	1250	1000	2
NXI_0416 6		416	170M6277	3SHT	1250	1000	4
NXI_0460 6	FI12	460	170M6305	3SHT	1250	700	4
NXI_0502 6		502	170M6305	3SHT	1250	700	4
NXI_0590 6		590	170M6305	3SHT	1250	700	4
NXI_0650 6		650	170M6277	3SHT	1250	1000	4
NXI_0750 6		750	170M6277	3SHT	1250	1000	4
NXI_0820 6		820	170M6277	3SHT	1250	1000	4
NXI_0920 6	FI13	920	170M6305	3SHT	1250	700	6
NXI_1030 6		1030	170M6277	3SHT	1250	1000	6
NXI_1180 6		1180	170M6277	3SHT	1250	1000	6
NXI_1500 6	FI14	1500	170M6277	3SHT	1250	1000	2 × 6
NXI_1900 6		1900	170M6277	3SHT	1250	1000	2 × 6
NXI_2250 6		2250	170M6277	3SHT	1250	1000	2 × 6

Table 6-3. Fuses used in Vacon NX (640 - 1100V)

Information about fuses:

gR fuses are designed to protect the device against both overcurrent and short-circuits.

aR fuses protect the cables of the device against short-circuits.

gG fuses are generally used to protect cables against overcurrent and short-circuits.

6.1.1.5 *Inverter supply and motor cables, NXI xxxx 5*

Frame	Type	IL [A]	Module supply (DC) (per terminal) Cu [mm ²]	Motor cable [mm ²]
NXI_0168 5	FI9	170	¹⁾ 2x(1x24)	Cu: 3x95+50 Al: 3x120+70
NXI_0205 5		205	¹⁾ 2x(1x24)	Cu: 3x150+70 Al: 3x240Al+72Cu
NXI_0261 5		261	¹⁾ 3x(1x24)	Cu: 3x185+95 Al: 2x(3x120+70)
NXI_0300 5		300	¹⁾ 6x(1x24)	Cu: 2x(3x120+70) Al: 2x(3x185Al+57Cu)
NXI_0385 5	FI10	385	²⁾ 5x40	Cu: 2x(3x120+70) Al: 2x(3x185Al+57Cu)
NXI_0460 5		460	²⁾ 5x40	Cu: 2x(3x150+70) Al: 2x(3x240Al+72Cu)
NXI_0520 5		520	²⁾ 6x40	Cu: 2x(3x185+95) Al: 2x(3x300Al+88Cu)
NXI_0590 5	³⁾ FI12	590	²⁾ 5x40	Cu: 2x(3x240+120) Al: 4x(3x120Al+41Cu)
NXI_0650 5		650	²⁾ 5x40	Cu: 4x(3x95+50) Al: 4x(3x150Al+41Cu)
NXI_0730 5		730	²⁾ 5x40	Cu: 4x(3x120+70) Al: 4x(3x185Al+57Cu)
NXI_0820 5		820	²⁾ 5x40	Cu: 4x(3x150+70) Al: 4x(3x185Al+57Cu)
NXI_0920 5		920	²⁾ 5x40	Cu: 4x(3x150+70) Al: 4x(3x240Al+72Cu)
NXI_1030 5		1030	²⁾ 6x40	Cu: 4x(3x185+95) Al: 4x(3x300Al+88Cu)
NXI_1150 5	FI13	1150	²⁾ 5x40	Cu: 4x(3x240+170) Al: 6x (3x185Al+57Cu)
NXI_1300 5		1300	²⁾ 5x40	Cu: 6x(3x150+70) Al: 6x (3x240Al+70Cu)
NXI_1450 5		1450	²⁾ 6x40	Cu: 6x(3x185+95) Al: 6x (3x240Al+70Cu)
NXI_1770 5	³⁾ FI14	1770	²⁾ 5x40	Cu: 2x 4x(3x240+170) Al: 2x 6x (3x185Al+57Cu)
NXI_2150 5		2150	²⁾ 5x40	Cu: 2x 6x(3x150+70) Al: 2x 6x (3x240Al+70Cu)
NXI_2700 5		2700	²⁾ 6x40	Cu: 2x 6x(3x185+95) Al: 2x 6x (3x240Al+70Cu)

Note:
¹⁾ Flexible conductor. Min. temperature endurance for isolation 70°C
²⁾ Copper Busbar
³⁾ The modules requires symmetrical parallel cable with min length 40m or dU/dt- or sinus filter.
 Table valid for enclosure class IP20 cabinets
 Motor cables:
 EN 60204-1, IEC 60364-5-2/2001
 - PVC insulation
 - 40 °C ambient temperature
 - 70 °C surface temperature

Table 6-4. Cable sizes for Vacon NX_5

6.1.1.6 Terminal sizes, NXI xxx 5

Frame	Type	I _L [A]	DC supply terminal]	Motor cable terminal
NXI_0168 5	FI9	170		
NXI_0205 5		205		
NXI_0261 5		261		
NXI_0300 5		300		
NXI_0385 5	FI10	385		
NXI_0460 5		460		
NXI_0520 5		520		
NXI_0590 5	FI12	590		
NXI_0650 5		650		
NXI_0730 5		730		
NXI_0820 5		820		
NXI_0920 5		920		
NXI_1030 5		1030		
NXI_1150 5	FI13	1150		
NXI_1300 5		1300		
NXI_1450 5		1450		

Table 6-5. Terminal sizes for Vacon NX₅

6.1.1.7 Inverter supply and motor cables, NXI xxx 6

Frame	Type	IL [A]	Module supply (DC) Cu [mm2]	Motor cable [mm2]
NXI_0125 6	FI9	125	¹⁾ 2x(1x24)	Cu: 3x95+50 Al: 3x120+70
NXI_0144 6		144	¹⁾ 2x(1x24)	Cu: 3x95+50 Al: 3x120+70
NXI_0170 6		170	¹⁾ 2x(1x24)	Cu: 3x95+50 Al: 3x120+70
NXI_0208 6		208	¹⁾ 2x(1x24)	Cu: 3150+70 Al: 3x240Al+72Cu
NXI_0261 6	FI10	261	¹⁾ 3x(1x24)	Cu: 3x185+95 Al: 2x(3x95Al+29Cu)
NXI_0325 6		325	²⁾ 5x40	Cu: 2x(3x95+50) Al: 2x(3x150Al+41 Cu)
NXI_0385 6		385	²⁾ 5x40	Cu: 2x(3x120+70) Al: 2x(3x185Al+57Cu)
NXI_0416 6		416	²⁾ 5x40	Cu: 2x(3x150+70) Al: 2x(3x185Al+57Cu)
NXI_0460 6	³⁾ FI12	460	²⁾ 5x40	Cu: 2x(3x150+70) Al: 2x(3x240Al+72Cu)
NXI_0502 6		502	²⁾ 5x40	Cu: 2x(3x185+95) Al: 2x(3x300Al+88 Cu)
NXI_0590 6		590	²⁾ 5x40	Cu: 2x(3x240+120) Al: 4x(3x120Al+41Cu)
NXI_0650 6		650	²⁾ 5x40	Cu: 4x(3x95+50) Al: 4x(3x150Al+41 Cu)
NXI_0750 6		750	²⁾ 5x40	Cu: 4x(3x120+70) Al: 4x(3x150Al+41 Cu)
NXI_0820 6		820	²⁾ 5x40	Cu: 4x(3x150+70) Al: 4x(3x185Al+57Cu)
NXI_0920 6	FI13	920	²⁾ 5x40	Cu:4x(3x150+70) Al:4x(3x240+72Cu)
NXI_1030 6		1030	²⁾ 5x40	Cu:4x(3x185+95) Al:5x(3x185+57Cu)
NXI_1180 6		1180	²⁾ 5x40	Cu:5x(3x185+95) Al:6x(3x185+72Cu)
NXI_0920 6	³⁾ FI14	1500	²⁾ 5x40	Cu: 2x4x(3x120+70) Al: 2x4x(3x150Al+41Cu)
NXI_1030 6		1900	²⁾ 5x40	Cu: 2x4x(3x185+95) Al: 2x5x(3x185+57Cu)
NXI_1180 6		2250	²⁾ 5x40	Cu: 2x5x(3x185+95) Al: 2x6x(3x185+72Cu)

Note:

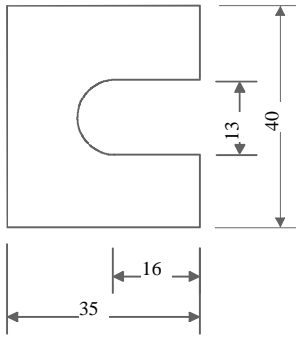
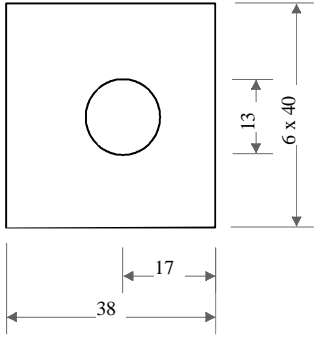
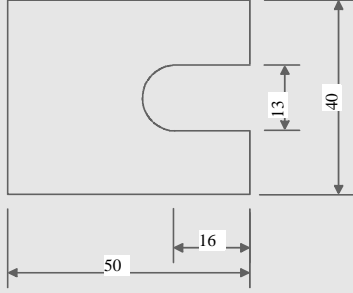
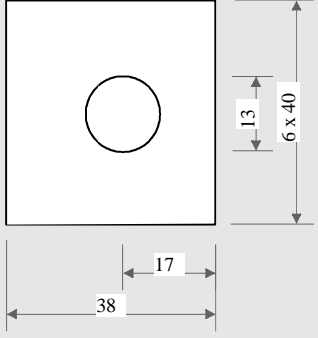
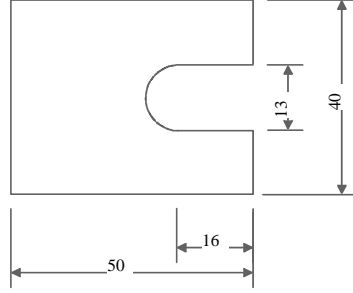
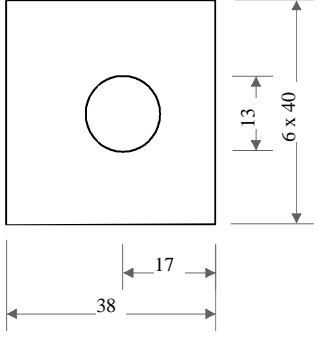
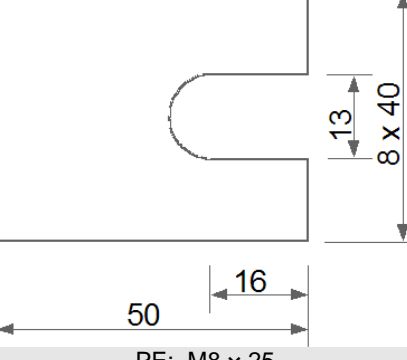
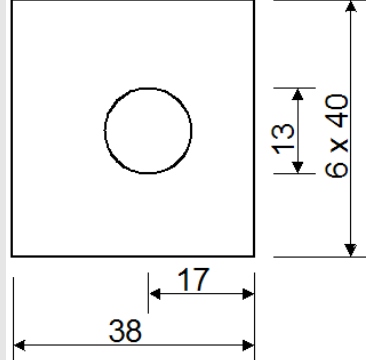
¹⁾ Flexible conductor. Min. temperature endurance for isolation 70°C

²⁾ Copper Busbar

²⁾ ³⁾ The modules requires symmetrical parallel cable with min length 40m or dU/dt- or sinus filter.

Table valid for enclosure class IP20 cabinets

Motor cables:

EN 60204-1, IEC 60364-5-2/2001

- PVC insulation
- 40 °C ambient temperature
- 70 °C surface temperature

Table 6-6. Cable sizes for Vacon NX_6

6.1.1.8 Terminal sizes, NXI xxx 6

Frame	Type	IL [A]	DC supply terminal	Motor cable Terminal
NXI_0125 6	FI9	125	 <p>PE: M8x25</p>	
NXI_0144 6		144		
NXI_0170 6		170		
NXI_0208 6		208		
NXI_0261 6	FI10	261	 <p>PE: M8x25</p>	
NXI_0325 6		325		
NXI_0385 6		385		
NXI_0416 6		416		
NXI_0460 6	FI12	460	 <p>PE: M8x25</p>	
NXI_0502 6		502		
NXI_0590 6		590		
NXI_0650 6		650		
NXI_0750 6		750		
NXI_0820 6		820		
NXI_0920 6	FI13	920	 <p>PE: M8x25</p>	
NXI_1030 6		1030		
NXI_1180 6		1180		

Table 6-7. Terminal sizes for Vacon NX_5

6.1.2 Installation instructions

1	Before starting the installation, check that none of the components of the inverter are live.												
2	In accordance with protection class IP00 requirements. There is no need to install the inverter cover if the inverter is installed in a cubicle, separate cabinet or device space.												
3	<p>Place the motor cables sufficiently far from other cables:</p> <ul style="list-style-type: none"> ▪ Avoid placing the motor cables in long parallel lines with other cables ▪ If the motor cables runs in parallel with other cables, note the minimum distances between the motor cables and other cables given in the table below. ▪ The given distances also apply between the motor cables and signal cables of other systems. ▪ The maximum length of the motor cables is 300 m. If output du/dt filters (+DUT option) are used the cable length is limited according to the table below: <table border="1" style="margin-left: auto; margin-right: auto;"> <thead> <tr> <th>Maximum cable length with du/dt filter</th> <th>Switching frequency</th> </tr> </thead> <tbody> <tr> <td>100m</td> <td>3,6kHz</td> </tr> <tr> <td>300m</td> <td>1,5kHz</td> </tr> </tbody> </table> <ul style="list-style-type: none"> ▪ The motor cables should cross other cables at an angle of 90 degrees. <table border="1" style="margin-left: auto; margin-right: auto;"> <thead> <tr> <th>Distance between cables [m]</th> <th>Shielded cable [m]</th> </tr> </thead> <tbody> <tr> <td>0.3</td> <td>≤50</td> </tr> <tr> <td>1.0</td> <td>≤200</td> </tr> </tbody> </table>	Maximum cable length with du/dt filter	Switching frequency	100m	3,6kHz	300m	1,5kHz	Distance between cables [m]	Shielded cable [m]	0.3	≤50	1.0	≤200
Maximum cable length with du/dt filter	Switching frequency												
100m	3,6kHz												
300m	1,5kHz												
Distance between cables [m]	Shielded cable [m]												
0.3	≤50												
1.0	≤200												
4	If cable insulation checks are needed, see Chapter 6.1.4.												

	5	<p>Connect the cables:</p> <ul style="list-style-type: none">▪ Remove the screws of the cable protection plate. Do not open the cover of the power unit!▪ Make holes into and pass the cables through the rubber grommets on the bottom of the power unit. The rubber grommets are delivered in a separate bag.▪ Connect the DC supply, motor and control cables into their respective terminals.▪ For Information on cable installation according to UL regulations, see Chapter 6.1.3.▪ Cable installation according to EMC regulations: The output cables to the motor must be 360° EMC earthed. The EMC grounding clamps can, for instance, be installed on the mounting plate. The EMC grounding clamps must be suited to the output cable diameter to give a 360° contact with the cables.▪ Make sure that the control cable wires do not come in contact with the electronic components of the unit.▪ Check the connection of the earth cable to the motor and the inverter terminals marked with Ⓧ.▪ Connect the separate shield of the power cable to the earth terminals of the inverter, motor and the supply centre.▪ Attach the cable protection plate with the screws.▪ Ensure that the control cables or the cables of the unit are not trapped between the frame and the protection plate.
--	----------	---

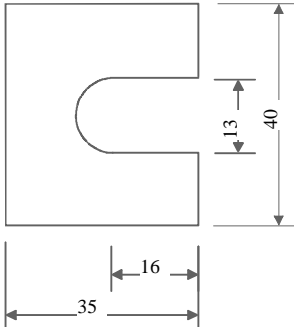
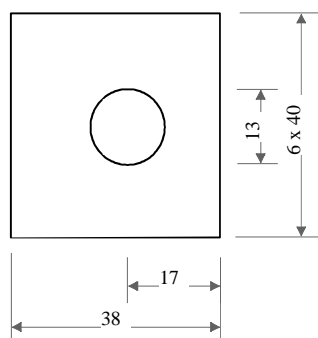
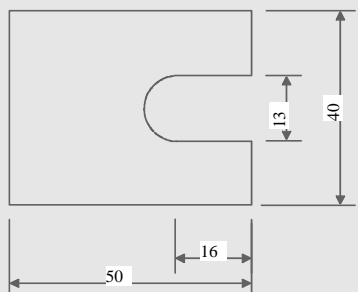
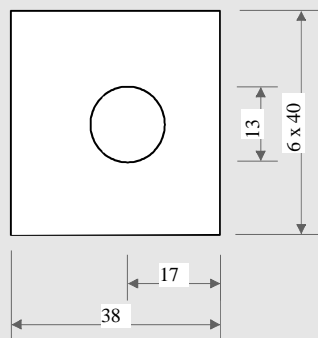
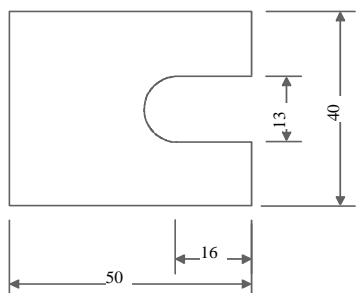
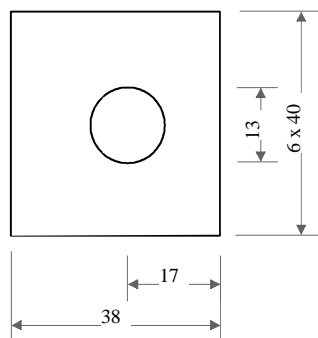
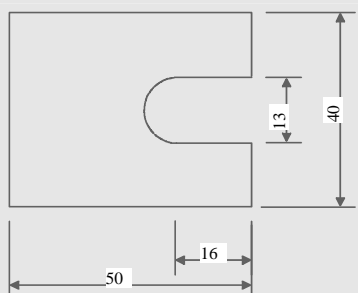
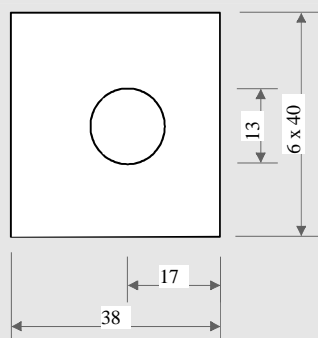
6.1.2.1 Vacon NXI frames



Figure 6-9. Vacon NXI, F19. Protection class IP00



Figure 6-10. Vacon NXI, F110. Protection class IP00



Figure 6-11. Vacon NXI, F12. Protection class IP00



Figure 6-12. Vacon NXI, F113. Protection class IP00

6.1.3 Cable installation and the UL standards

To meet the UL ([Underwriters Laboratories](#)) regulations, a UL-approved copper cable with a minimum heat-resistance of +60/75°C must be used.

The tightening torques of the terminals are given below in Table 6–8.

Type	Frame	DC terminals Tightening torque [Nm]				AC terminals Tightening torque [Nm]			
		Bolt Ø	Min	Nom	Max	Bolt Ø	Min	Nom	Max
NXI_0168 - 0300 5 NXI_0125 -0208 6	FI9	M10	35	40	45	M10	35	40	45
NXI_0385 - 0520 5 NXI_0261 - 0416 6	FI10	M12	65	70	75	M10	35	40	45
NXI_0590 - 1030 5 NXI_0460 - 0820 6	FI12	M10	35	40	45	2 x M10	35	40	45
NXI_1150 - 1450 5 NXI_0920 - 1180 6	FI13	M12	65	70	75	3 x M12	65	70	75
NXI_1770 - 2700 5 NXI_1500 - 2250 6	FI14	M12	65	70	75	6 x M12	65	70	75

Table 6–8. Tightening torques of terminals

6.1.4 Cable and motor insulation checks

1. Motor cable insulation checks

Disconnect the motor cable from terminals U, V, and W of the inverter and from the motor. Measure the insulation resistance of the motor cable between each phase conductor as well as between each phase conductor and the protective ground conductor. The insulation resistance must be >1MΩ.

2. DC supply cable insulation checks

Disconnect the DC supply cable from terminals DC- and DC+ of the inverter and from DC supply. Measure the insulation resistance between each conductor and ground. The insulation resistance must be >1MΩ.

3. Motor insulation checks

Disconnect the motor cable from the motor and open the bridging connections in the motor connection box. Measure the insulation resistance of each motor winding. The measurement voltage must equal at least the motor nominal voltage but not exceed 1,000 V. The insulation resistance must be >1MΩ.

6.2 Control unit

The control unit of the inverter consists of the control board and option boards (see Figure 6-13 and Figure 6-20) connected to the five slot connectors (A to E) on the control board. The control board is connected to the power unit through a D connector (1).

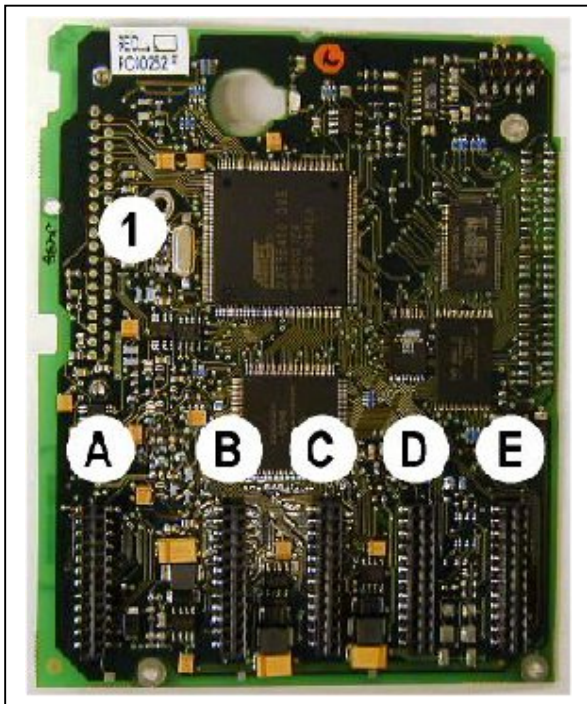

Figure 6-13. control board

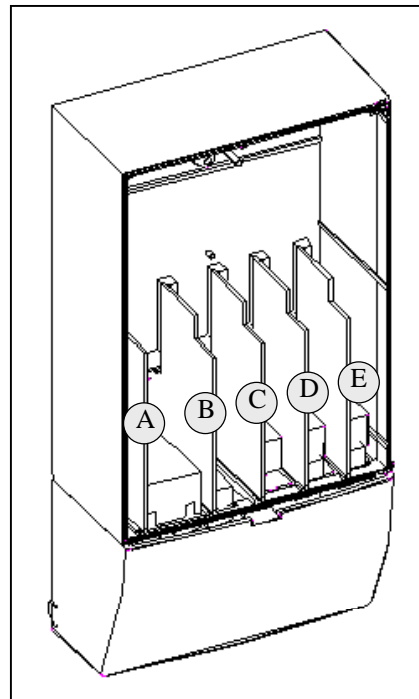
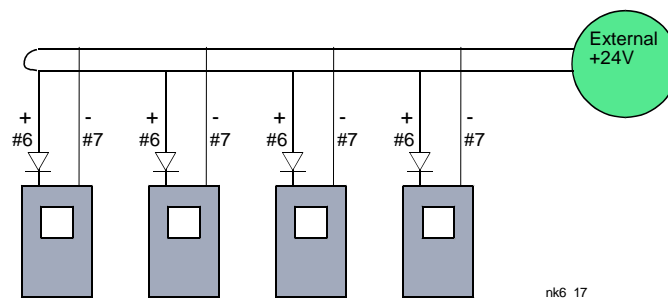

Figure 6-14. Basic and option board connections on the control board

When the inverter is delivered from the factory, the control unit usually includes two basic boards (I/O board and relay board), which are normally installed in slots A and B. On the next pages you will find the arrangement of the control I/O and the relay terminals of the two basic boards, the [general wiring diagram](#) and the [control signal](#) descriptions. The I/O boards mounted at the factory are indicated in the type code. For more information on the option boards, see Vacon NX option board manual (ud741).

The control board can be powered externally (+24V) by connecting the external power source to bidirectional terminal #6 (see Table 6-9). This voltage is sufficient for parameter setting and for keeping the fieldbus active.

Note! If the +24V input of several inverters are connected in parallel, we recommend to use a diode in terminal #6 to avoid the current to flow in opposite direction, which might damage the control board.



6.2.1 Control connections

The basic control connections for boards A1 and A2/A3 are shown in Chapter 0. The inverters are equipped with A1 and A2 boards as standard. The signal descriptions for the standard application are presented in Chapter 2 of the All in One Application Manual. You can find the signal descriptions for **other applications** in the Vacon NX Application Manual.

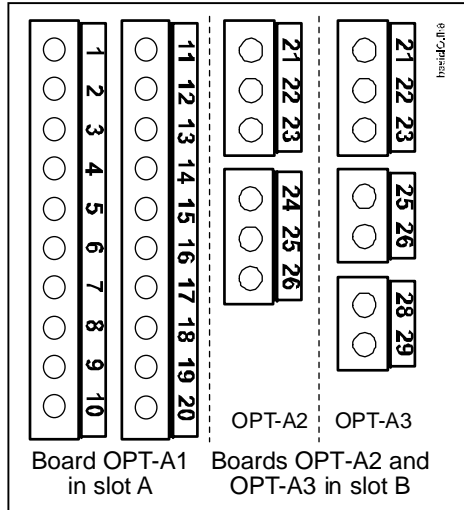

Figure 6-15. The I/O terminals of the two basic boards

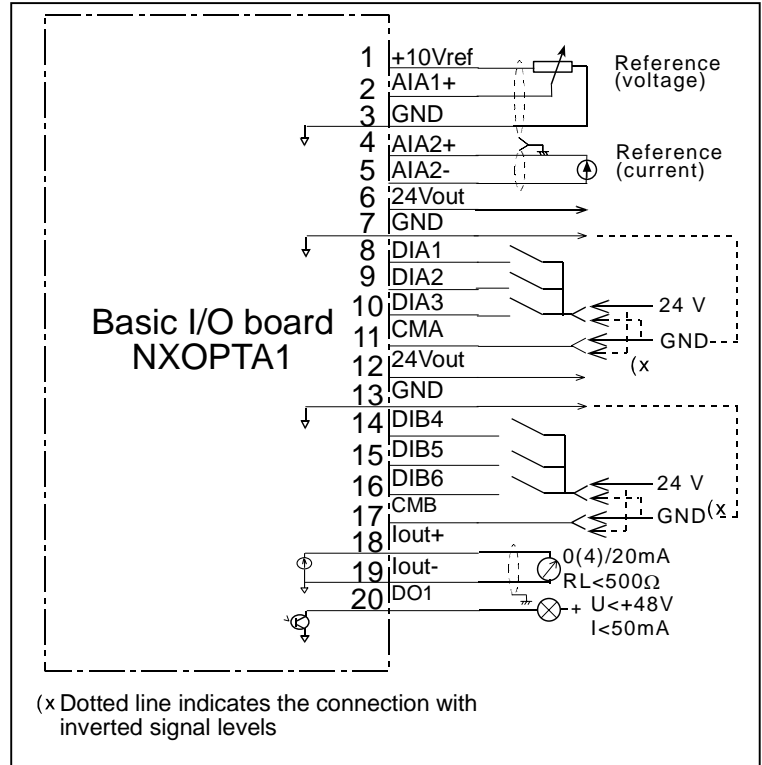

Figure 6-16. General wiring diagram of the basic I/O board (OPT-A1)

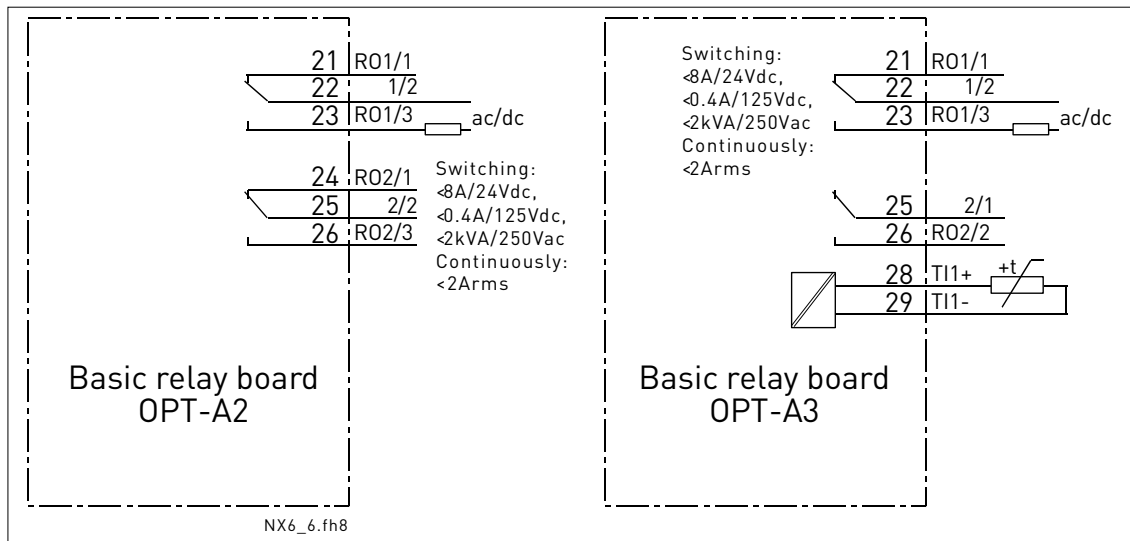

Figure 6-17. General wiring diagram of the basic relay boards (OPT-A2/OPT-A3)

6.2.1.1 Control cables

The control cables shall be at least 0.5 mm² screened multicore cables, see Table 6–9. The maximum terminal wire size is 2.5 mm² for the relay terminals and 1.5 mm² for other terminals.

You can find the tightening torques of the option board terminals below.

Terminal screw	Tightening torque	
	Nm	lb-in.
Relay and thermistor terminals (screw M3)	0.5	4.5
Other terminals (screw M2.6)	0.2	1.8

Table 6–9. Tightening torques of terminals

6.2.1.2 Galvanic isolation barriers

The control connections are isolated from the mains potential and the GND terminals are permanently connected to ground. See below.

The digital inputs are galvanically isolated from the I/O ground. The relay outputs are additionally double-isolated from each other at 300VAC (EN-50178).

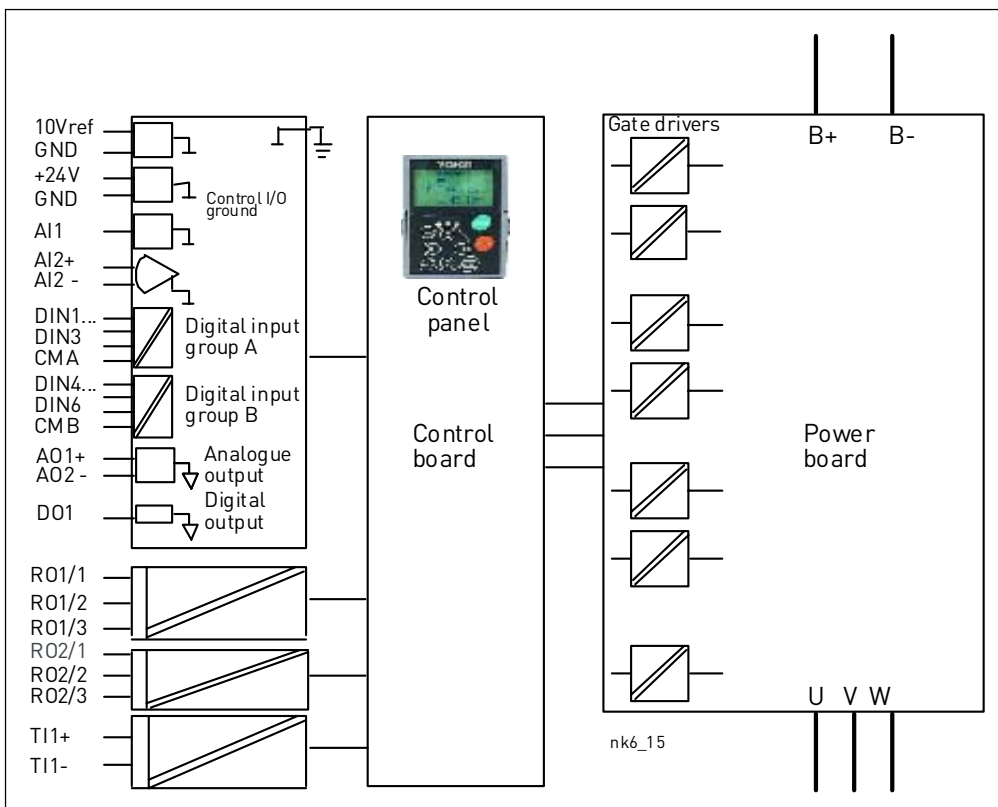

Figure 6-18. Galvanic isolation barriers.

6.2.2 Control terminal signals

Terminal		Signal	Technical information
1	+10 Vref	Reference voltage	Maximum current 10 mA
2	AI1+	Analogue input, voltage or current	Selection V or mA with jumper block X1 (see page 58): Default: 0– +10V ($R_i = 200\text{ k}\Omega$) (-10V.....+10V Joy-stick control, selected with a jumper) 0– 20mA ($R_i = 250\ \Omega$)
3	GND/AI1–	Analogue input common	
4	AI2+	Analogue input, voltage or current	Selection V or mA with jumper block X1 (see page 58): Default: 0– 20mA ($R_i = 250\ \Omega$) 0– +10V ($R_i = 200\text{ k}\Omega$) (-10V.....+10V Joy-stick control, selected with a jumper)
5	GND/AI2–	Analogue input common	
6	24 Vout (bidirectional)	24V auxiliary voltage	Differential input if not connected to ground; Allows $\pm 20\text{V}$ differential mode voltage to GND
7	GND	I/O ground	$\pm 15\%$; maximum current 250 mA all boards total; 150 mA from single board. Can also be used as external power backup for the control unit (and fieldbus).
8	DIN1	Digital input 1	Ground for reference and controls
9	DIN2	Digital input 2	
10	DIN3	Digital input 3	
11	CMA	Digital input common A for DIN1, DIN2 and DIN3.	$R_i = \text{min. } 5\text{k}\Omega$ $18\text{...}30\text{V} = "1"$
12	24 Vout (bidirectional)	24V auxiliary voltage	Must be connected to GND or 24V of I/O terminal or to external 24V or GND Selection with jumper block X3 (see page 58):
13	GND	I/O ground	Same as terminal #6
14	DIN4	Digital input 4	Same as terminal #7
15	DIN5	Digital input 5	
16	DIN6	Digital input 6	
17	CMB	Digital input common B for DIN4, DIN5 and DIN6	$R_i = \text{min. } 5\text{k}\Omega$ $18\text{...}30\text{V} = "1"$
18	A01+	Analogue signal (+output)	Must be connected to GND or 24V of I/O terminal or to external 24V or GND Selection with jumper block X3 (see page 58): Output signal range: Current 0(4)–20mA, R_L max. 500 Ω or Voltage 0– 10V, $R_L > 1\text{k}\Omega$ Selection with jumper block X3 (see page 58):
19	A01–	Analogue output common	
20	D01	Open collector output	Maximum $U_{in} = 48\text{VDC}$ Maximum current = 50 mA

Table 6–10. Control I/O terminal signals on basic I/O board OPT-A1

OPT-A2					
21	R01/1	1	Relay output	Switching capacity	24VDC/8A
22	R01/2				250VAC/8A
23	R01/3				125VDC/0.4A
				Min.switching load	5V/10mA
24	R02/1	2	Relay output	Switching capacity	24VDC/8A
25	R02/2				250VAC/8A
26	R02/3				125VDC/0.4A
				Min.switching load	5V/10mA

Table 6-11. Control I/O terminal signals on basic relay board OPT-A2

OPT-A3					
21	R01/1	1	Relay output	Switching capacity	24VDC/8A
22	R01/2				250VAC/8A
23	R01/3				125VDC/0.4A
				Min.switching load	5V/10mA
25	R02/1	2	Relay output	Switching capacity	24VDC/8A
26	R02/2				250VAC/8A
				Min.switching load	125VDC/0.4A
28	TI1+	Thermistor input			
29	TI1-				

Table 6-12. Control I/O terminal signals on basic relay board OPT-A3

6.2.2.1 Digital input signal inversions

The active signal level depends on which potential the common inputs CMA and CMB (terminals 11 and 17) are connected to. The alternatives are either +24V or ground (0 V). See Figure 6-19. We recommend the use of positive logic in all control connections of the inverter. If negative logic is used, additional appropriate measures are needed to meet the safety regulation requirements.

The 24 volt control voltage and the ground for the digital inputs and the common inputs (CMA, CMB) can be either internal or external.

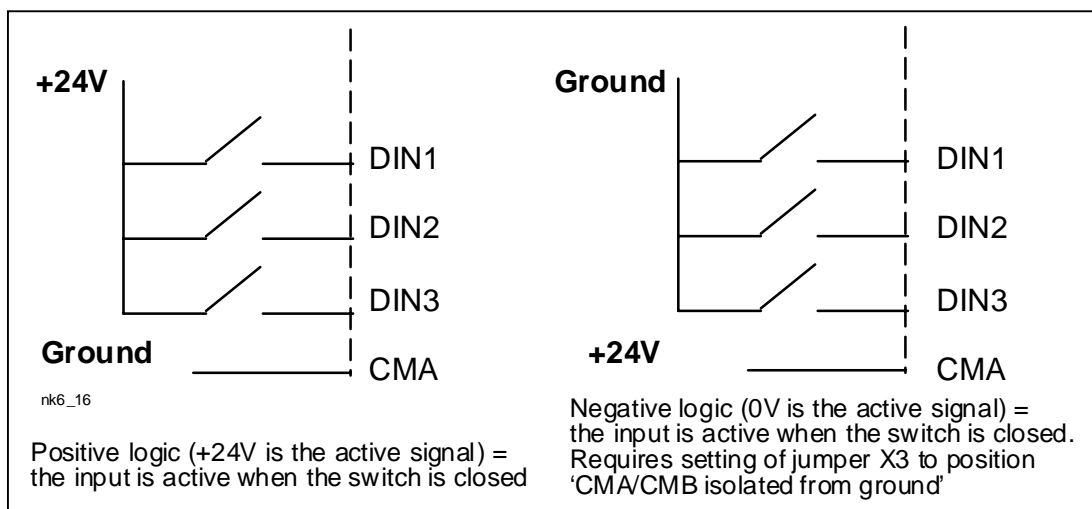

Figure 6-19. Positive/Negative logic

6.2.2.2 Jumper selections on the OPT-A1 basic board

The user can customise the functions of the inverter to better suit his needs by selecting certain positions for the jumpers on the OPT-A1 board. The positions of the jumpers determine the signal type of analogue and digital inputs.

On the A1 basic board, there are four jumper blocks (X1, X2, X3 and X6) each containing eight pins and two jumpers. The selection possibilities of the jumpers are shown on page 58 (Figure 6-21).

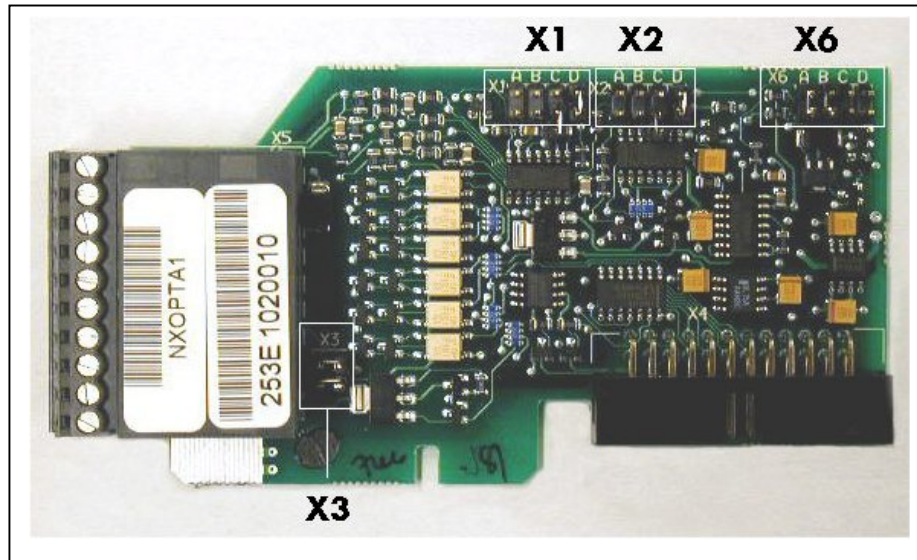

Figure 6-20. Jumper blocks on OPT-A1

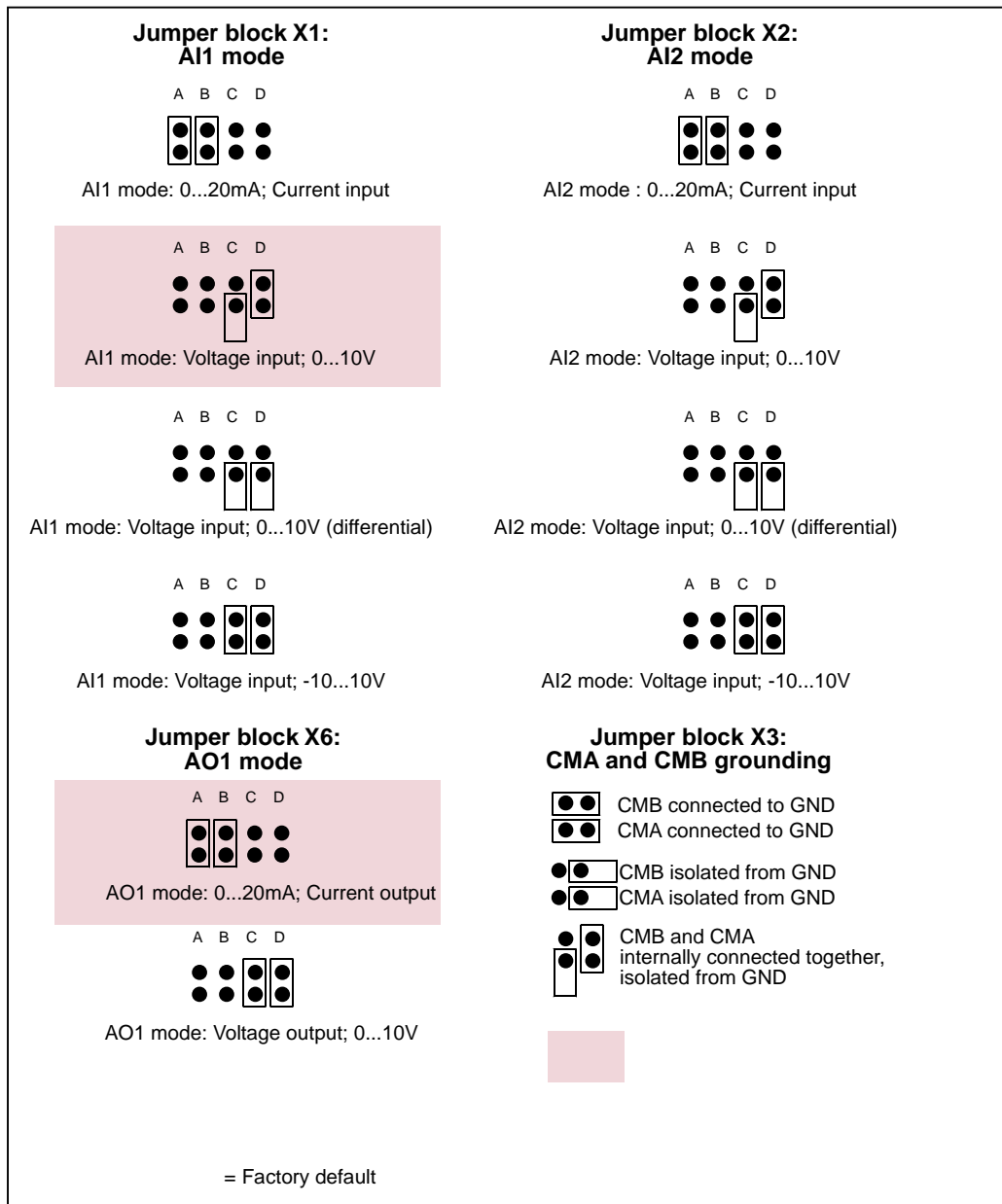





Figure 6-21. Jumper selection for OPT-A1

 VAROITUS	<p>Ensure that the jumper positions are correct. Running the motor with signal settings that differ from the jumper positions will not harm the inverter but may harm the motor.</p>
 HUOM!	<p>Note: If you change the AI/AO signal content also remember to change the corresponding board parameter in menu M7.</p>

7. CONTROL KEYPAD

The control keypad is the link between the Vacon inverter and the user. The Vacon NX control keypad features an alphanumeric display with seven indicators for the Run status (RUN, , READY, STOP, ALARM, FAULT) and three indicators for the control place (I/O term/ Keypad/BusComm). There are also three Status Indicator LEDs (green – green – red), see section 7.1.3.

The control information, i.e. the menu number, description of the menu or the displayed value and the numeric information are presented on three text lines.

The inverter is operable through the nine push-buttons of the control keypad. Furthermore, the buttons can be used in setting parameters and monitoring values.

The keypad is detachable and isolated from the input line potential.

7.1 Indicators on the keypad display

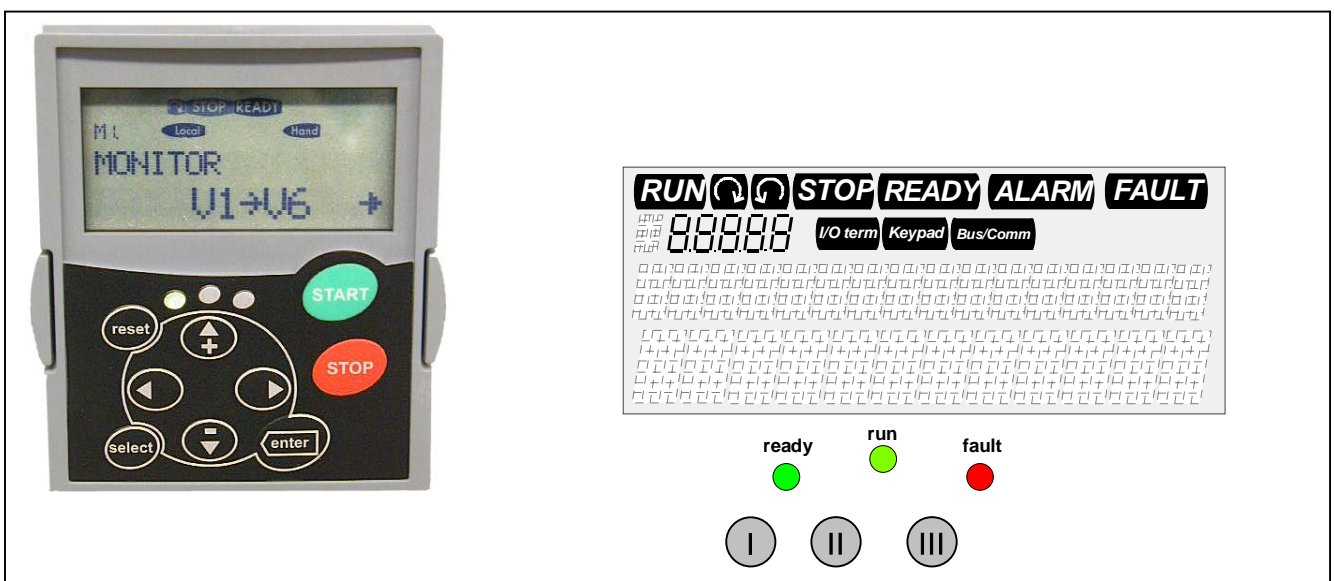



Figure 7-1. Vacon control keypad and drive status indications

7.1.1 Drive status indications [See the keypad](#)

The drive status symbols tell the user the status of the motor and the inverter. In addition, they tell about possible irregularities detected by the motor control software in motor or inverter functions.

- 1 RUN = Motor is running; Blinks when the stop command has been given but the frequency is still ramping down.
- 2  = Indicates the direction of motor rotation.
- 3 STOP = Indicates that the drive is not running.

- 4 READY = Lights up when AC power is on. In case of a trip, the symbol will not light up.
- 5 ALARM = Indicates that the drive is running outside a certain limit and a warning is given.
- 6 FAULT = Indicates that unsafe operating conditions were encountered due to which the drive was stopped.



7.1.2 Control place indications [See the keypad](#)

The symbols *I/O term*, *Keypad* and *Bus/Comm* (see Figure 7-1) indicate the choice of control place made in the Keypad control menu (M3) (see Chapter 7.3.3).

- a *I/O term* = I/O terminals are selected as the control place i.e. START/STOP commands or reference values etc. are given through the I/O terminals.
- b *Keypad* = Control keypad is selected as the control place i.e. the motor can be started or stopped, or its reference values etc. altered from the keypad.
- c *Bus/Comm* = The inverter is controlled through a fieldbus.

7.1.3 Status LEDs (*green – green – red*) [See the keypad](#)

The status LEDs light up in connection with the READY, RUN and FAULT drive status indicators.

- I  = lights up with the AC power connected to the drive. Simultaneously, the drive status indicator READY is lit up.
- II  = Lights up when the drive is running. Blinks when the STOP button has been pushed and the drive is ramping down.
- III  = Lights up when unsafe operating conditions were encountered due to which the drive was stopped (Fault Trip). Simultaneously, the drive status indicator FAULT blinks on the display and the fault description can be seen, see Chapter 7.3.3.4, Active faults.

7.1.4 Text lines [See the keypad](#)

The three text lines (●, ●●, ●●●) provide the users with information on their present location in the keypad menu structure as well as with information related to the operation of the drive.

- = Location indicator; displays the symbol and number of the menu, parameter, etc.
Example: **M2** = Menu 2 (Parameters); **P2.1.3** = Acceleration time
- = Description line; Displays the description of the menu, value or fault.
- = Value line; Displays the numerical and textual values of references, parameters, etc. and the number of submenus available in each menu.

7.2 Keypad push-buttons

The Vacon alphanumeric control keypad has 9 push-buttons that are used for controlling the inverter (and motor), setting parameters, and monitoring values.

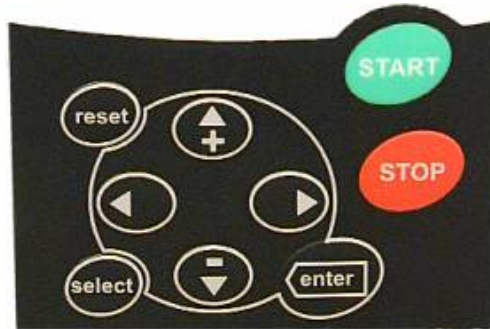



Figure 7-1 Keypad push-buttons

7.2.1 Button descriptions

- reset = This button is used to reset active faults (see Chapter 7.3.3.4).
- select = This button is used to switch between the two latest displays. This may be useful when you want to see how the changed new value influences some other value.
- enter = The enter button is used for:
 - 1) confirmation of selections
 - 2) fault history reset (2...3 seconds)
- ▲
+ = Browser button up
Browse the main menu and the pages of different submenus.
Edit values.
- ▼ = Browser button down
Browse the main menu and the pages of different submenus.
Edit values.
- ◀ = Menu button left
Move backward in menu.
Move cursor left (in parameter menu).
Exit edit mode.
Press for 2 to 3 seconds to return to main menu.

- ▶ = Menu button right
Move forward in menu.
Move cursor right (in parameter menu).
Enter edit mode.
-  = Start button
Pressing this button starts the motor if the keypad is the active control place. See Chapter 7.3.3.
-  = Stop button
Pressing this button stops the motor (unless disabled by parameter R3.4/R3.6). See Chapter 7.3.3.

7.3 Navigation on the control keypad

The data on the control keypad is arranged in menus and submenus. The menus are used for the display and editing of measurement and control signals, parameter settings (see Chapter 7.3.2) and reference value and fault displays (see Chapter 7.3.3.4). Through the menus, you can also adjust the contrast of the display (see Chapter 7.3.6.6).

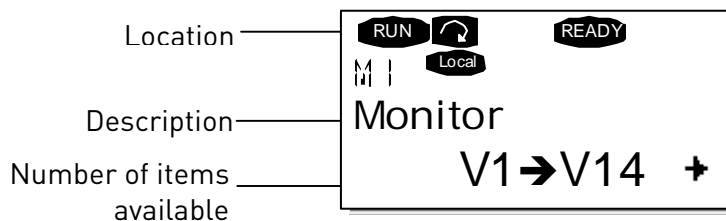

The first menu level consists of menus M1 to M7 and is called the *Main menu*. The user can navigate in the main menu with the *Browser buttons* up and down. The desired submenu can be entered from the main menu with the *Menu buttons*. When there still are pages to enter under the currently displayed menu or page, you can see an arrow (➔) in the lower right corner of the display and can reach the next menu level by pressing *Menu button right*.

The control keypad navigation chart is shown on the next page. Please note that menu **M1** is located in the lower left corner. From there you will be able to navigate your way up to the desired menu using the menu and browser buttons.

You will find more detailed descriptions of the menus later in this chapter.

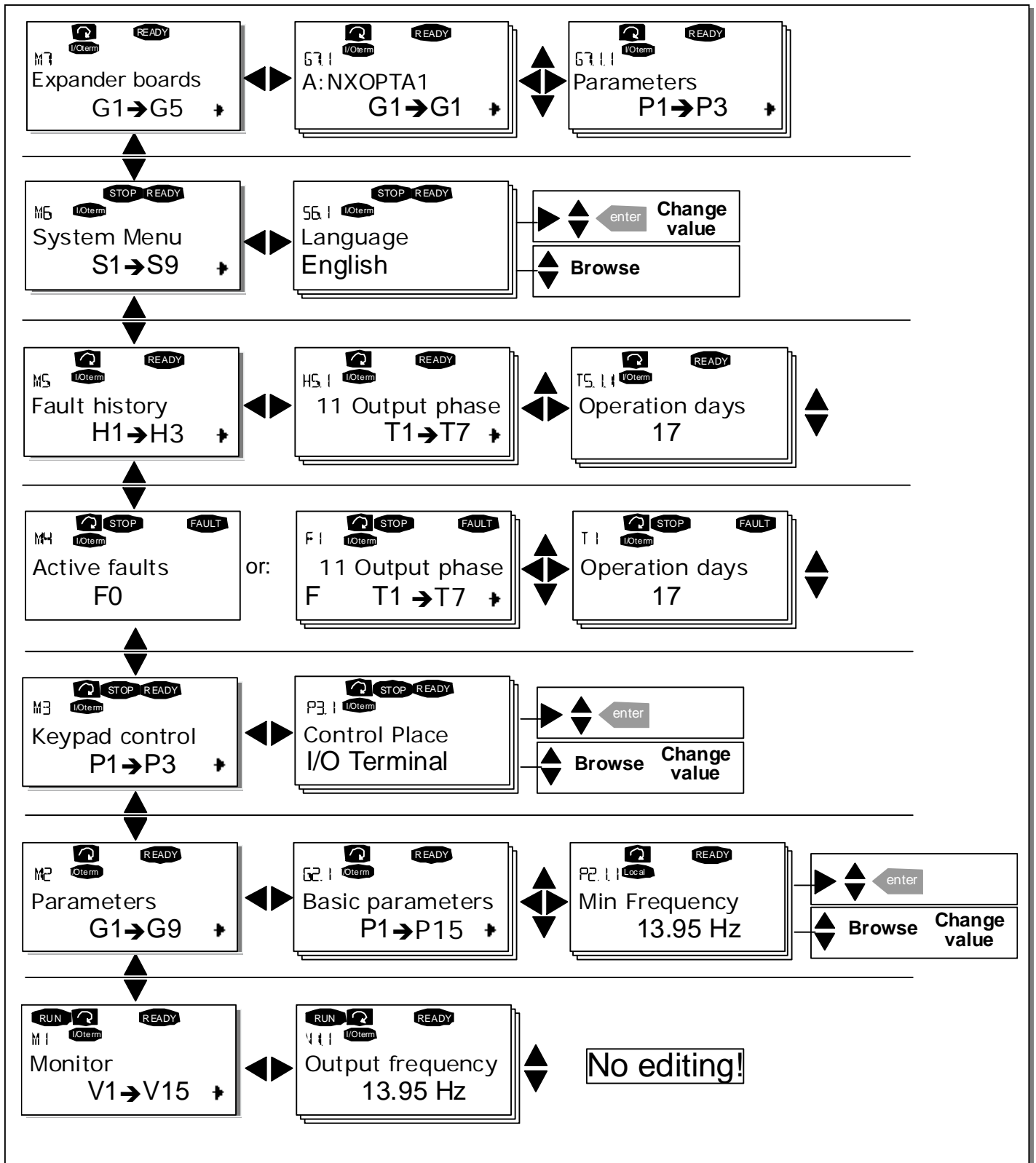

Figure 7-2 Keypad navigation chart

7.3.1 Monitoring menu (M1)

You can enter the Monitoring menu from the Main menu by pressing *Menu button right* when the location indication **M1** is visible on the first line of the display. Figure 3-1 shows how to browse through the monitored values.

The monitored signals carry the indication **V#.#** and they are listed in Table 7-1. The values are updated once every 0.3 seconds.

This menu is meant only for signal checking. The values cannot be altered here. For changing values of parameters, see Chapter 7.3.2.

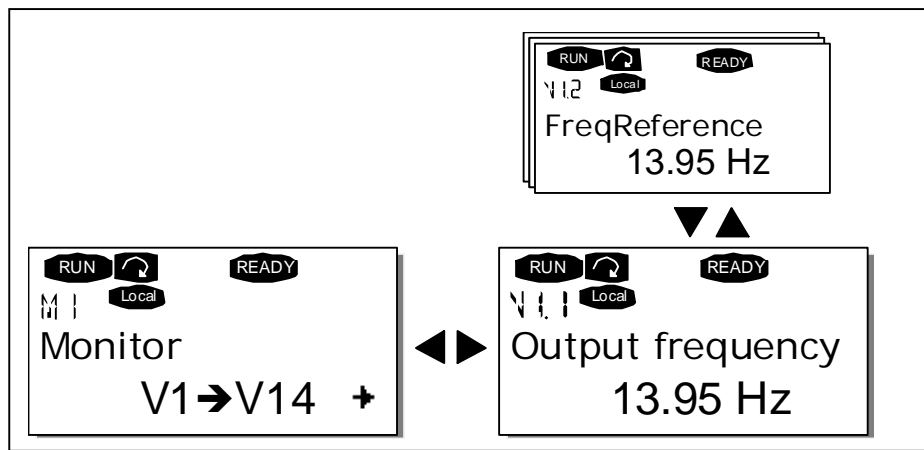

Figure 7-3 Monitoring menu

Code	Signal name	Unit	Description
V1.1	Output frequency	Hz	Frequency to the motor
V1.2	Frequency reference	Hz	
V1.3	Motor speed	rpm	Calculated motor speed
V1.4	Motor current	A	Measured motor current
V1.5	Motor torque	%	Calculated actual torque/nominal torque of the
V1.6	Motor power	%	Calculated actual power/nominal power of the
V1.7	Motor voltage	V	Calculated motor voltage
V1.8	DC-link voltage	V	Measured DC-link voltage
V1.9	Unit temperature	°C	Heat sink temperature
V1.10	Motor temperature	%	Calculated motor temperature
V1.11	Voltage input	V	AI1
V1.12	Current input	mA	AI2
V1.13	DIN1, DIN2, DIN3		Digital input statuses
V1.14	DIN4, DIN5, DIN6		Digital input statuses
V1.15	DO1, RO1, RO2		Digital and relay output statuses
V1.16	Analogue output	mA	AO1
M1.17	Multimonitoring items		Displays three selectable monitoring values. See chapter 7.3.6.5.

Table 7-1. Monitored signals

Note! All in One applications may embody more monitoring values.

7.3.2 Parameter menu (M2)

Parameters are the way of conveying the commands of the user to the inverter. Parameter values can be edited by entering the *Parameter Menu* from the *Main Menu* when the location indication **M2** is visible on the first line of the display. The value editing procedure is presented in Figure 7-1.

Pressing *Menu button right* once takes you to the Parameter Group Menu (*G#*). Locate the desired parameter group by using the *Browser buttons* and press *Menu button right* again to see the group and its parameters. Use the *Browser buttons* to find the parameter (P#) you want to edit. Pressing *Menu button right* takes you to the edit mode. As a sign of this, the parameter value starts to blink. You can now change the value in two different ways:

- Set the desired value with the *Browser buttons* and confirm the change with the *enter* button. Consequently, the blinking stops and the new value is visible in the value field.
- Press *Menu button right* once more. Now you will be able to edit the value digit by digit. This may come in handy, when a relatively greater or smaller value than that on the display is desired. Confirm the change with the *enter* button.

The value will not change unless the Enter button is pressed. Pressing *Menu button left* takes you back to the previous menu.

Several parameters are locked, i.e. cannot be edited, when the drive is in RUN status. If you try to change the value of such a parameter the text **Locked** will appear on the display. The inverter must be stopped to edit these parameters.

The parameter values can also be locked using the function in menu **M6** (see Chapter 6.5.2)).

You can return to the Main menu any time by pressing *Menu button left* for 1 to 2 seconds.

The basic application package "All in One+" includes seven applications with different sets of parameters. You will find the parameter lists in the Application Section of this manual.

Once in the last parameter of a parameter group, you can move directly to the first parameter of that group by pressing *Browser button up*.

See the diagram for parameter value change procedure on page 67.

Note: You can connect power to the control board by connecting the external power source to the bidirectional terminal #6 on the OPT-A1 board (see page 55). The external power source can also be connected to the corresponding +24V terminal on any option board. This voltage is sufficient for parameter setting and for keeping the fieldbus active.

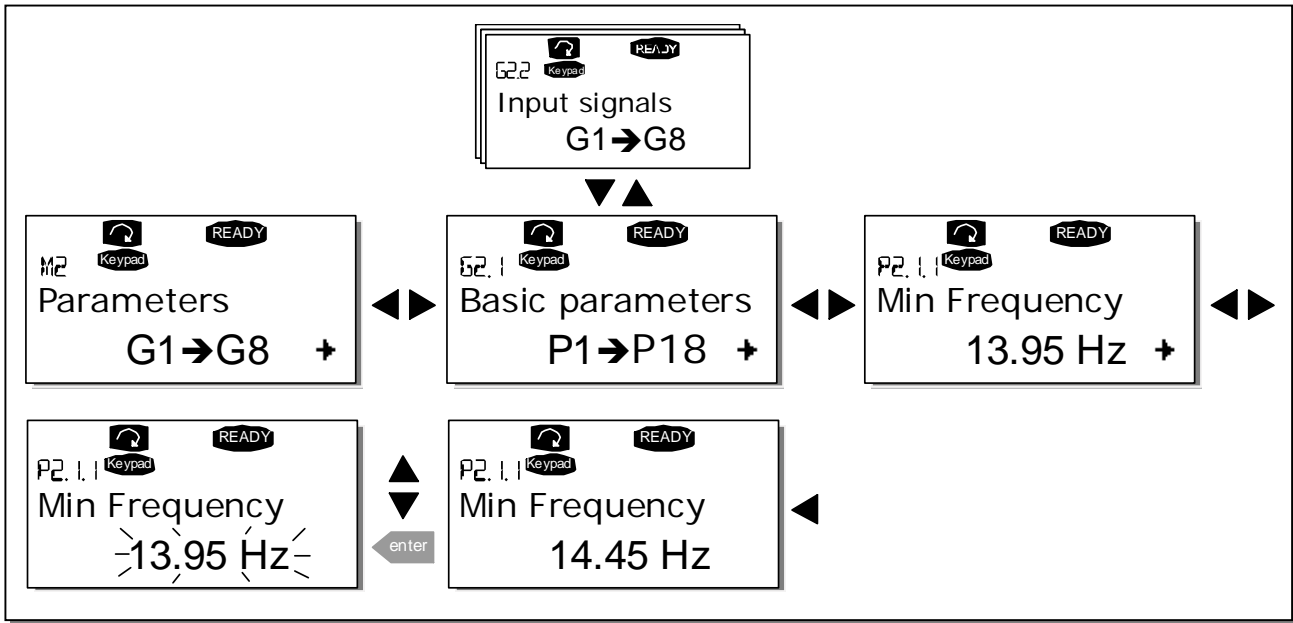



Figure 7-1. Parameter value change procedure

7.3.3 Keypad control menu (M3)

In the *Keypad Control Menu*, you can choose the control place, edit the frequency reference and change the direction of the motor. You can enter the submenu level by pressing *Menu button right*.

NOTE! *There are some special functions that can be performed in menu M3:*

Select the keypad as the active control place by pressing  for 3 seconds **when the motor is running**. The keypad will become the active control place and the current frequency reference and direction will be copied to the keypad.

Select the keypad as the active control place by pressing  for 3 seconds **when the motor is stopped**. The keypad will become the active control place and the current frequency reference and direction will be copied to the keypad.

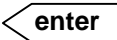
Copy the frequency reference set elsewhere (I/O, fieldbus) to the panel by pressing  for 3 seconds.

Note that if you are in any other than menu *M3* these functions will not work. If you are in some other than menu *M3* and try to start the motor by pressing the START button when the keypad is not selected as the active control place, you will get an error message: *Keypad Control NOT ACTIVE*.

7.3.3.1 Selection of control place

There are three different places (sources) where the inverter can be controlled from. For each control place, a different symbol will appear on the alphanumeric display:

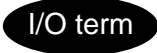
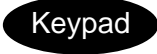
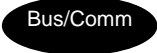
Control place	Symbol
I/O terminals	
Keypad (panel)	
Fieldbus	

You can change the control place by entering the edit mode with *Menu button right*. The options can then be browsed with the *Browser buttons*. Select the desired control place with the *enter* button. See the diagram on the next page. See also Chapter 7.3.3. above.

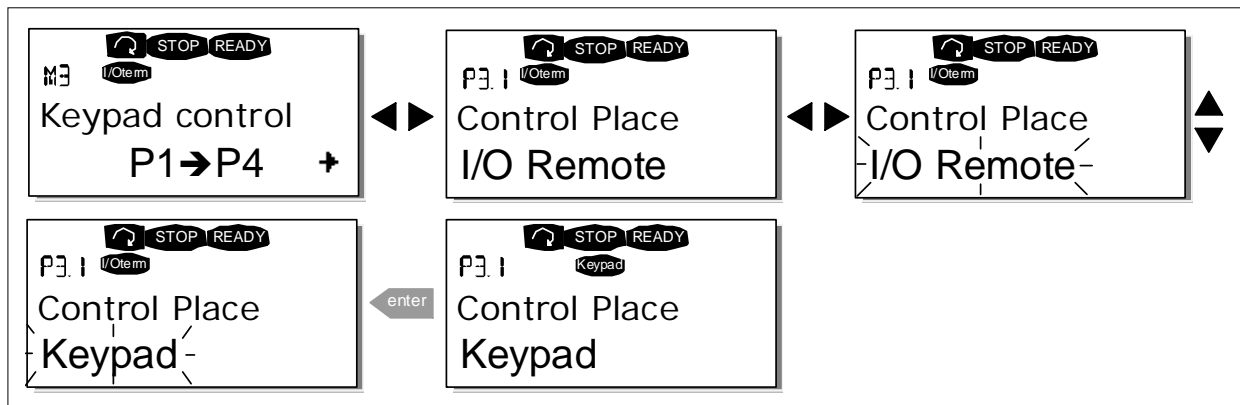

Figure 7-2. Selection of control place

7.3.3.2 Keypad reference

The keypad reference submenu (**P3.2**) displays and allows the operator to edit the frequency reference. The changes will take place immediately. **This reference value will not, however, influence the rotation speed of the motor unless the keypad has been selected as the active control place.**

NOTE: The maximum difference in RUN mode between the output frequency and the keypad reference is 6 Hz. The program automatically monitors the keypad reference value. See also Chapter 7.3.3.

Figure 7-1 shows how to edit the reference value (pressing the *enter* button is not necessary).

7.3.3.3 Keypad direction

The keypad direction submenu (**P3.3**) displays and allows the operator to change the rotating direction of the motor. **This setting will not, however, influence the rotation direction of the motor unless the keypad has been selected as the active control place.**

See also Chapter 7.3.3.

Note: For additional information on controlling the motor with the keypad, see Chapters 7.2.1, 7.3.3 and 8.2.

7.3.3.4 Stop button activated

By default, pushing the STOP button will **always** stop the motor regardless of the selected control place. You can disable this function by giving parameter 3.4 the value **0**. If the value of this parameter is **0**, the STOP button will stop the motor only **when the keypad has been selected as the active control place.**

7.3.4 Active faults menu (M4)

You can enter the Active faults menu from the Main menu by pressing *Menu button right* when the location indication **M4** is visible on the first line of the keypad display.

When a fault brings the inverter to a stop, the location indication F1, the fault code, a short description of the fault, and the **fault type symbol** (see Chapter 7.3.4.1) will appear on the display. In addition, the indication FAULT or ALARM (see Figure 7-1 or Chapter 7.1.1) is displayed and, in case of a FAULT, the **red LED** on the keypad starts to blink. If several faults occur simultaneously, the list of active faults can be browsed with the *Browser buttons*.

The memory of active faults can store a maximum of 10 faults in the order of appearance. The display can be cleared with the *reset* button and the read-out will return to the same state it was in before the fault trip. The fault remains active until it is cleared with the *reset button* or with a reset signal from the I/O terminal.

Note! Remove external Start signal before resetting the fault to prevent unintentional restart of the drive.



7.3.4.1 Fault types

The NX inverter has four types of faults. These types differ from each other on the basis of the subsequent behaviour of the drive. See Table 7-1.

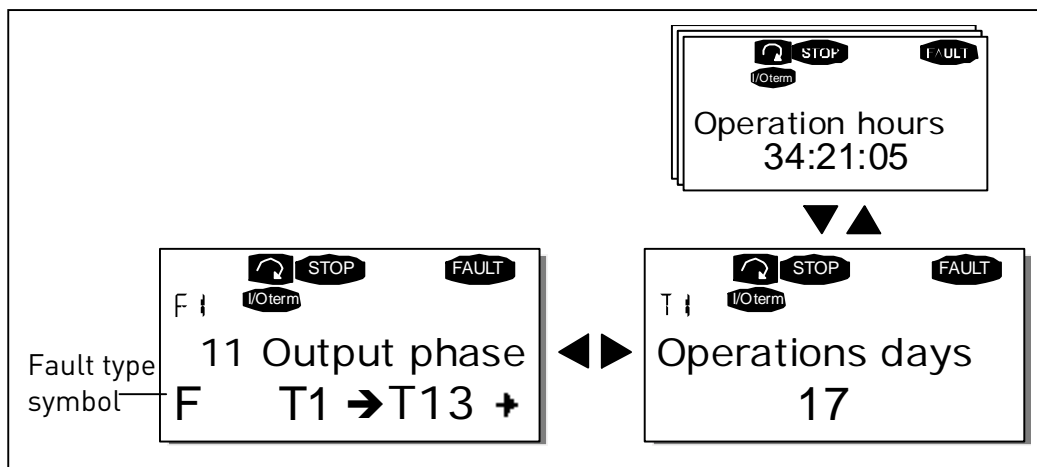

Figure 7-3. Fault display

Fault type symbol	Meaning
A (Alarm)	This type of fault is a sign of an unusual operating condition. It does not cause the drive to stop, nor does it require any special actions. The 'A fault' remains in the display for about 30 seconds.
F (Fault)	An 'F fault' makes the drive stop. Actions need to be taken to restart the drive.
AR (Fault Autoreset)	If an 'AR fault' occurs the drive will stop immediately. The fault is reset automatically and the drive tries to restart the motor. Finally, if the restart is not successful, a fault trip (FT, see below) occurs.
FT (Fault Trip)	If the drive is unable to restart the motor after an AR fault an FT fault occurs. The 'FT fault' has basically the same effect as the F fault: the drive is stopped.

Table 7-1. Fault types

7.3.4.2 *Fault codes*

The fault codes, their causes and correcting actions are presented in the table below. The shadowed faults are A faults only. The items in white on black background are faults for which you can program different responses in the application. See parameter group Protections.

Note! When contacting the distributor or factory because of a fault condition, always write down all texts and codes visible on the keypad display.

Fault code	Fault	Possible cause	Correcting measures
1	Overcurrent	Inverter has detected too high a current ($>4 \cdot I_n$) in the motor cable: sudden heavy load increase short circuit in motor cables unsuitable motor	Check loading. Check motor. Check cables.
2	Overvoltage	The DC-link voltage has exceeded the limits defined in too short a deceleration time high overvoltage spikes in supply	Set the deceleration time longer. Add a brake chopper or a brake resistor.
3	Earth fault	Current measurement has detected that the sum of motor phase current is not zero. insulation failure in cables or motor	Check motor cable and motor.
5	Charging switch	The charging switch is open, when the START command has been given. faulty operation component failure	Reset the fault and restart. Should the fault re-occur, contact the distributor near to you. Please visit: http://www.vacon.com/wwcontacts.html
6	Emergency stop	Stop signal has been given from the option board.	
7	Saturation trip	Various causes: component failure brake resistor short-circuit or overload	Cannot be reset from the keypad. Switch off power. DO NOT RE-CONNECT POWER! Contact factory. If this fault appears simultaneously with Fault 1, check motor cables and motor
8	System fault	component failure faulty operation Note the exceptional Fault data record. See 7.3.4.3.	Reset the fault and restart. Should the fault re-occur, contact the distributor near to you. Please visit: http://www.vacon.com/wwcontacts.html
9	Undervoltage	DC-link voltage is under the voltage limits defined in most probable cause: too low a supply voltage inverter internal fault	In case of temporary supply voltage break, reset the fault and restart the inverter. Check the supply voltage. If it is adequate, an internal failure has occurred. Contact the nearest Vacon distributor. Please visit: http://www.vacon.com/wwcontacts.html
11	Output phase supervision	Current measurement has detected that there is no current in one motor phase.	Check motor cable and motor.

12	Brake chopper supervision	No brake resistor installed brake resistor is broken brake chopper failure	Check brake resistor. If the resistor is ok, the chopper is faulty. Contact the distributor near to you. Please visit: http://www.vacon.com/wwcontacts.html
13	Inverter undertemperature	Heatsink temperature is under -10°C	
14	Inverter overtemperature	Heatsink temperature is over 90°C or 77°C (NX_6, FR6). Overtemperature warning is issued when the heatsink temperature exceeds 85°C (72°C).	Check the correct amount and flow of cooling air. Check the heatsink for dust. Check the ambient temperature. Make sure that the switching frequency is not too high in relation to ambient temperature and motor load.
15	Motor stalled	Motor stall protection has tripped.	Check motor.
16	Motor over-temperature	Motor overheating has been detected by inverter motor temperature model. Motor is overloaded.	Decrease the motor load. If no motor overload exists, check the temperature model parameters.
17	Motor underload	Motor underload protection has tripped.	
22	EEPROM checksum fault	Parameter save fault faulty operation component failure	
24	Counter fault	Values displayed on counters are incorrect	
25	Microprocessor watchdog fault	faulty operation component failure	Reset the fault and restart. Should the fault re-occur, contact the distributor near to you. Please visit: http://www.vacon.com/wwcontacts.html
26	Start-up prevented	Start-up of the drive has been prevented.	Cancel prevention of start-up.
29	Thermistor fault	The thermistor input of option board has detected increase of the motor temperature	Check motor cooling and loading Check thermistor connection (If thermistor input of the option board is not in use it has to be short circuited)
31	IGBT temperature (hardware)	IGBT Inverter Bridge overtemperature protection has detected too high a short term overload current	Check loading. Check motor size.
32	Fan cooling	Cooling fan of the inverter does not start, when ON command is given.	Contact the nearest Vacon distributor. Please visit: http://www.vacon.com/wwcontacts.html
34	CAN bus communication	Sent message not acknowledged.	Ensure that there is another device on the bus with the same configuration.
36	Control unit	NXS Control Unit can not control NXP Power Unit and vice versa	Change control unit
37	Device changed (same type)	Option board or control unit changed. Same type of board or same power rating of drive.	Reset Note: No fault time data record!
38	Device added (same type)	Option board or drive added. Drive of same power rating or same type of board added.	Reset Note: No fault time data record!
39	Device removed	Option board removed. Drive removed.	Reset Note: No fault time data record!

40	Device unknown	Unknown option board or drive.	Contact the nearest Vacon distributor. Please visit: http://www.vacon.com/wwcontacts.html
41	IGBT temperature	IGBT Inverter Bridge overtemperature protection has detected too high a short term overload current	Check loading. Check motor size.
42	Brake resistor overtemperature	Brake resistor overtemperature protection has detected too heavy braking	Set the deceleration time longer. Use external brake resistor.
43	Encoder fault	Note the exceptional Fault data record. See 7.3.4.3. Additional codes: 1 = Encoder 1 channel A is missing 2 = Encoder 1 channel B is missing 3 = Both encoder 1 channels are missing 4 = Encoder reversed	Check encoder channel connections. Check the encoder board.
44	Device changed (different type)	Option board or control unit changed. Option board of different type or different power rating of drive.	Reset Note: No fault time data record! Note: Application parameter values restored to default.
45	Device added (different type)	Option board or drive added. Option board of different type or drive of different power rating added.	Reset Note: No fault time data record! Note: Application parameter values restored to default.
50	Analogue input (sel. signal range 4 to 20 mA) _{<0>}	Current at the analogue input is < 4mA. control cable is broken or loose signal source has failed	Check the current loop circuitry.
51	External fault	Digital input fault.	
52	Keypad communication fault	There is no connection between the control keypad and the inverter.	Check keypad connection and possible keypad cable.
53	Fieldbus fault	The data connection between the fieldbus Master and the fieldbus board is broken	Check installation. If installation is correct contact the nearest Vacon distributor. Please visit: http://www.vacon.com/wwcontacts.html
54	Slot fault	Defective option board or slot	Check board and slot. Contact the nearest Vacon distributor. Please visit: http://www.vacon.com/wwcontacts.html
56	PT100 board temp. fault	Temperature limit values set for the PT100 board parameters have been exceeded	Find the cause of temperature rise

Table 7-2. Fault codes

7.3.4.3 *Fault time data record*

When a fault occurs, the information described in Chapter 7.3.3.4 is displayed. By pressing *Menu button right*, you will enter the *Fault time data record menu* indicated by T.1→T.#. In this menu, some selected important data valid at the time of the fault are recorded. This feature will help the user or the service person in determining the cause of the fault.

The data available are:

T.1	Counted operation days <i>(Fault 43: Additional code)</i>	(d)
T.2	Counted operation hours <i>(Fault 43: Counted operation days)</i>	(hh:mm:ss) (d)
T.3	Output frequency <i>(Fault 43: Counted operation hours)</i>	Hz (hh:mm:ss)
T.4	Motor current	A
T.5	Motor voltage	V
T.6	Motor power	%
T.7	Motor torque	%
T.8	DC voltage	V
T.9	Unit temperature	°C
T.10	Run status	
T.11	Direction	
T.12	Warnings	
T.13	0-speed*	

Table 7-3. *Fault time recorded data*

* Tells the user if the drive was at zero speed (< 0.01 Hz) when the fault occurred

Real time record

If real time is set to run on the inverter, the data items T1 and T2 will appear as follows:

T.1	Counted operation days	yyyy-mm-dd
T.2	Counted operation hours	hh:mm:ss,sss

7.3.5 Fault history menu (M5)

Vikahistoria-avaliikkoon pääsee Päävalikosta painamalla *Oikeanpuoleista valikkonäppäintä* kun You can enter the *Fault history menu* from the *Main menu* by pressing *Menu button right* when the location indication **M5** is visible on the first line of the keypad display.

All faults are stored in the *Fault history menu* where you can browse them with the *Browser buttons*. Additionally, the *Fault time data record* pages (see Chapter 7.3.4.3) are accessible for each fault. You can return to the previous menu any time by pressing *Menu button left*.

The memory of the inverter can store a maximum of 30 faults in order of appearance. The number of faults currently in the fault history is shown on the *value line* of the main page (**H1→H#**). The order of the faults is indicated by the *location indication* in the upper left corner of the display. The latest fault is indicated by F5.1, the one before that by F5.2 and so on. If there are 30 uncleared faults in the memory, the next fault will erase the oldest fault from the memory.

Pressing the *enter* button for about 2 to 3 seconds resets the whole fault history. The symbol **H#** will change to **0**.

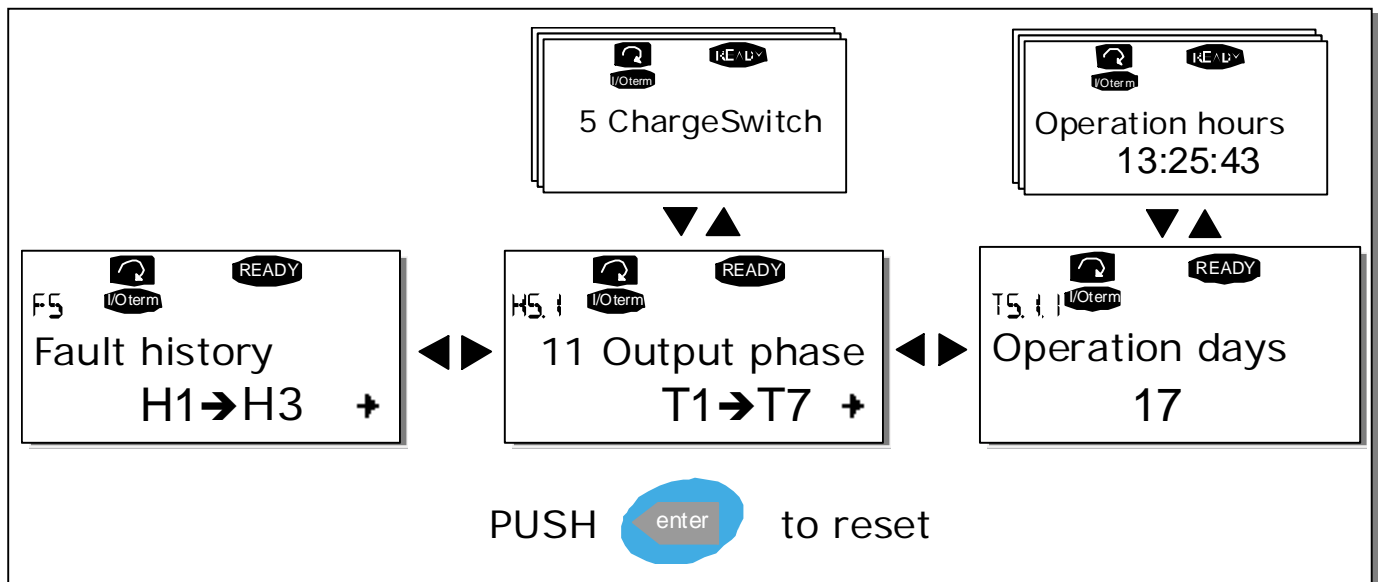

Figure 7-4. Fault history menu

7.3.6 *System menu (M6)*

You can enter the *System menu* from the *Main menu* by pressing *Menu button right* when the location indication **M6** is visible on the first line of the keypad display.

The controls associated with the general use of the inverter, such as application selection, customised parameter sets or information about the hardware and software are located under the *System menu*. The number of submenus and subpages is shown with the symbol **S** (or **P**) on the [value line](#).

Page 78 has a table of the functions available in the System menu.

System menu functions

Code	Function	Min	Max	Unit	Default	Cust	Selections
S6.1	Selection of language				English		English Deutsch Suomi Svenska Italiano
S6.2	Application selection				Basic Application		Basic Application Standard Application Local/Remote control Appl. Multi-Step Application PID Control Application Multi-Purpose Control Appl. Pump and Fan Control Appl.
S6.3	Copy parameters						
S6.3.1	Parameter sets						Load factory defaults Store set 1 Load set 1 Store set 2 Load set 2
S6.3.2	Load to keypad						All parameters
S6.3.3	Load from keypad						All parameters All but motor parameters Application parameters
P6.3.4	Parameter backup				Yes		No Yes
S6.4	Parameter comparison						
S6.5	Safety						
S6.5.1	Password				Not used		0=Not used
P6.5.2	Parameter locking				Change Enabled		Change Enabled Change Disabled
S6.5.3	Start-up wizard						No Yes
S6.5.4	Multimonitoring items				Change Enabled		Change Enabled Change Disabled
S6.6	Keypad settings						
P6.6.1	Default page						
P6.6.2	Default page/OM						
P6.6.3	Timeout time	0	65535	s	30		
P6.6.4	Contrast	0	31		18		
P6.6.5	Backlight time	Always	65535	min	10		
S6.7	Hardware settings						
P6.7.1	Internal brake resistor				Connected		Not connected Connected
P6.7.2	Fan control function				Continuous		Continuous Temperature
P6.7.3	HMI acknowledg.	200	5000	ms	200		
P6.7.4	HMI: no. of retries	1	10		5		
S6.8	System information						
S6.8.1	Total counters						
C6.8.10.1.	MWh counter			kWh			
C6.8.10.2.	Operation day counter						
C6.8.1.3.	Operation hour counter						
S6.8.2	Trip counters						
T6.8.2.1	MWh counter			kWh			
T6.8.2.2	Clear MWh counter						

T6.8.2.3	Operation day counter						
T6.8.2.4	Operation hour counter						
T6.8.2.5	Clear operation hour counter						
S6.8.3	oftware informatio						
S6.8.3.1	Software package						
S6.8.3.2	System software version						
S6.8.3.3	Firmware interface						
S6.8.3.4	System load						
S6.8.4	Applications						
S6.8.4.#	<i>Name of application</i>						
D6.8.4.#.1	Application ID						
D6.8.4.#.2	Applications: version						
D6.8.4.#.3	Applications: firmware interface						
S6.8.5	Hardware						
I6.8.5.1	Unit power						
I6.8.5.2	Unit voltage						
I6.8.5.3	Info: Brake chopper						
I6.8.5.4	Info: Brake resistor						
S6.8.6	Expander boards						

Table 7-4. System menu functions

7.3.6.1 Selection of language

The Vacon control keypad offers you the possibility to control the inverter through the keypad in the language of your choice.

Locate the language selection page under the *System menu*. Its location indication is **S6.1**. Press *Menu button right* once to enter the edit mode. As the name of the language starts to blink you can select another language for the keypad texts. Confirm with the *enter* button. The blinking stops and all text information on the keypad is presented in the selected language.

You can return to the previous menu any time by pressing *Menu button left*.

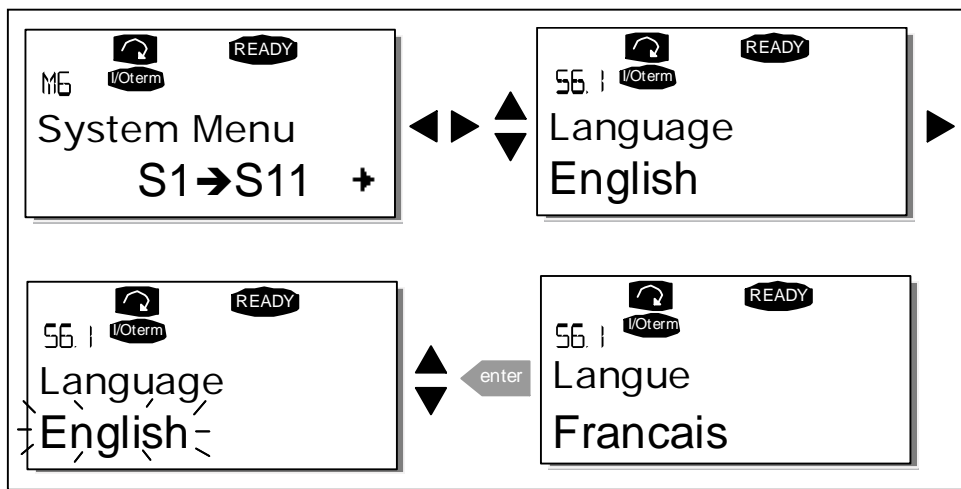

Figure 7-5. Selection of language

7.3.6.2 Application selection

The user can select the desired application on the *Application selection page (S6.2)*. To enter the page, press *Menu button right* on the first page of the *System menu*. To change the application, press *Menu button right* once more. The name of the application starts to blink. Now you can browse the applications with the *Browser buttons* and select the desired application with the *enter* button.

After application change, you will be asked if you want the parameters of the **new** application to be uploaded to the keypad. If you want to do this, press the *enter* button. Pressing any other button leaves the parameters of the **previously** used application saved in the keypad. For more information, see Chapter 7.3.6.3.

For more information about the Application Package, see Vacon NX Application Manual.

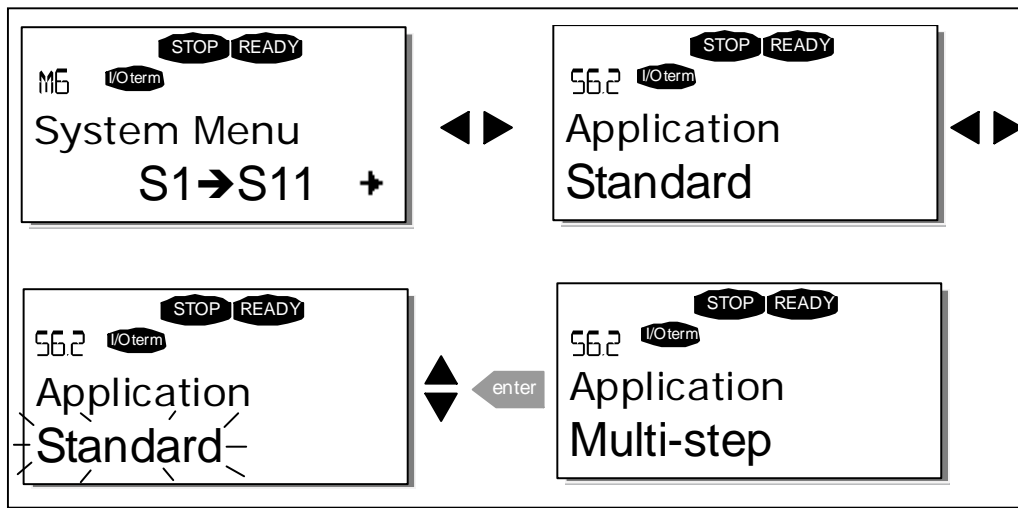

Figure 7-6. Change of application

7.3.6.3 Copy parameters

The parameter copy function is used when the operator wants to copy one or all parameter groups from one drive to another. All the parameter groups are first *uploaded* to the keypad, then the keypad is connected to another drive and then the parameter groups are *downloaded* to it (or possibly back to the same drive). For more information, see page 82.

Before any parameters can be successfully copied from one drive to another, the **drive** has to be **stopped** when the parameters are downloaded to it:

The parameter copy menu (S6.3) contains four functions:

Parameter sets (S6.3.1)

The user can reload the factory default parameter values and store and load two customised parameter sets (all parameters included in the application).

On the *Parameter sets* page (S6.3.1), press *Menu button right* to enter the *edit mode*. The text *LoadFactDef* begins to blink and you can confirm the loading of factory defaults by pressing the *enter* button. The drive resets automatically.

Alternatively, you can choose any other storing or loading functions with the *Browser buttons*. Confirm with the *enter* button. Wait until 'OK' appears on the display.

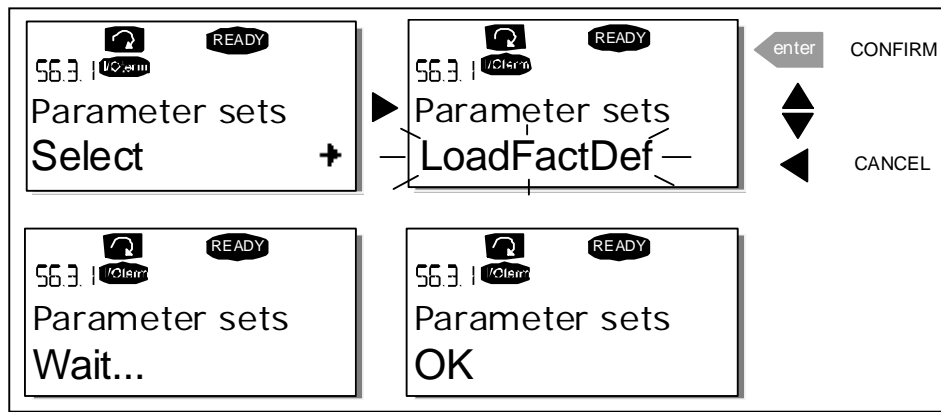

Figure 7-7. Storing and loading of parameter sets

Upload parameters to keypad (To keypad, S6.3.2)

This function uploads **all** existing parameter groups to the keypad provided that the drive is stopped.

Enter the *To keypad* page (S6.3.2) from the *Parameter copy menu*. Pressing *Menu button right* takes you to the edit mode. Use the *Browser buttons* to select the option *All parameters* and press the *enter* button. Wait until 'OK' appears on the display.

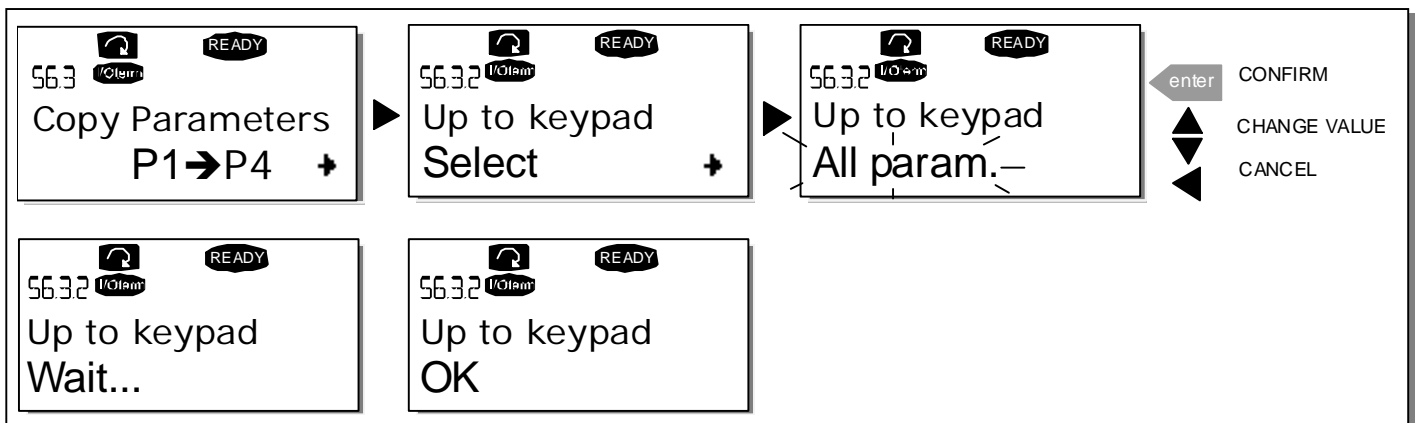

Figure 7-8. Parameter copy to keypad

Download parameters to drive (From keypad, S6.3.3)

This function downloads **one** or **all** parameter groups uploaded to the keypad to a drive provided that the drive is in STOP status.

Enter the *To keypad* page (S6.3.2) from the *Parameter copy menu*. Pressing the *Menu button right* takes you to the edit mode. Use the *Browser buttons* to select either *All parameters*, *All but motor parameters* or *Application parameters* and press the *Enter button*. Wait until 'OK' appears on the display.

The procedure to download the parameters from keypad to drive is similar to that of from drive to keypad. See Figure 7-8.

Automatic parameter backup (P6.3.4)

On this page you can activate or inactivate the parameter backup function. Enter the edit mode by pressing *Menu button right*. Select *Yes* or *No* with the *Browser buttons*.

When the Parameter backup function is activated Vacon NX control keypad makes a copy of the parameters of the presently used application. When applications are changed, you will be asked if you wish the parameters of the **new** application to be uploaded to the keypad. If you want to do this, press the *enter* button. If you wish to keep the copy of the parameters of the **previously used** application saved in the keypad, press any other button. Now you will be able to download these parameters to the drive following the instructions given in Chapter 7.3.6.3.

If you want the parameters of the new application to be automatically uploaded to the keypad you have to do this for the parameters of the new application once on page 6.3.2 as instructed. **Otherwise the panel will always ask for the permission to upload the parameters.**

Note: Parameters saved in the parameter settings on page **S6.3.1** will be deleted when applications are changed. If you want to transfer the parameters from one application to another, you have to upload them first to the keypad.

7.3.6.4 Parameter comparison

In the *Parameter comparison* submenu (**S6.4**), you can compare the **actual parameter values** to the values of your customised parameter sets and those loaded to the control keypad.

You can compare the parameter by pressing *Menu button right* in the *Compare parameters submenu*. The actual parameter values are first compared to those of the customised parameter Set1. If no differences are detected, '0' is displayed on the lowermost line. If any of the parameter values differ from those of Set1, the number of the deviations is displayed together with symbol **P** (for example, P1→P5 = five deviating values). By pressing *Menu button right* once more, you can enter pages where you can see both the actual value and the value it was compared to. In this display, the value on the *description line* (in the middle) is the default value and the one on the *value line* (lowermost) is the edited value. Furthermore, you can also edit the actual value with the *Browser buttons* in the *edit mode* which you can enter by pressing *Menu button right* once.

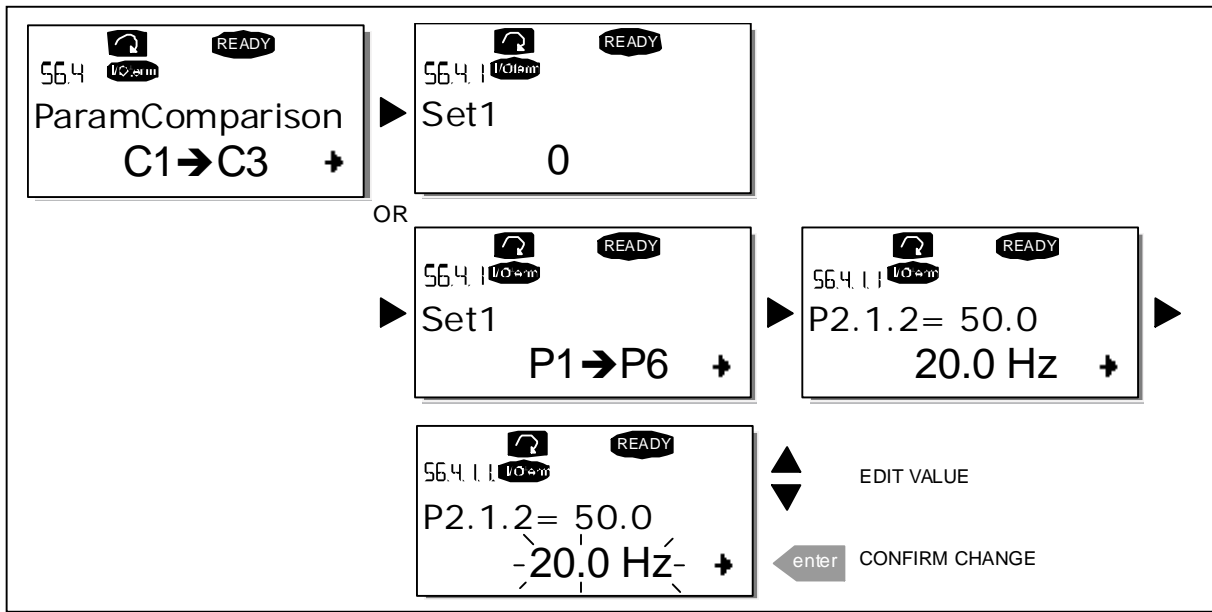

Figure 7-9. Parameter comparison

7.3.6.5 Safety

NOTE: The *Security submenu* is protected with a password. Store the password in a safe place!

Password (S6.5.1)

The application selection can be protected against unauthorised changes with the Password function (S6.5.1).

By default, the password function is not in use. If you want to activate the function, enter the edit mode by pressing *Menu button right*. A blinking zero appears in the display and you can set a password with the *Browser buttons*. The password can be any number between 1 and 65535.

Note that you can also set the password by digits. In the edit mode, push *Menu button right* again and another zero appears on the display. Set ones first. To set the tens, press *Menu button right*, and so on. Confirm the password with the *enter* button. After this, you have to wait until the *Timeout time* (P6.6.3) (see page 87) has expired before the password function is activated.

If you try to change applications or the password itself, you will be prompted for the current password. Enter the password with the *Browser buttons*.

You can deactivate the password function by entering the value 0.

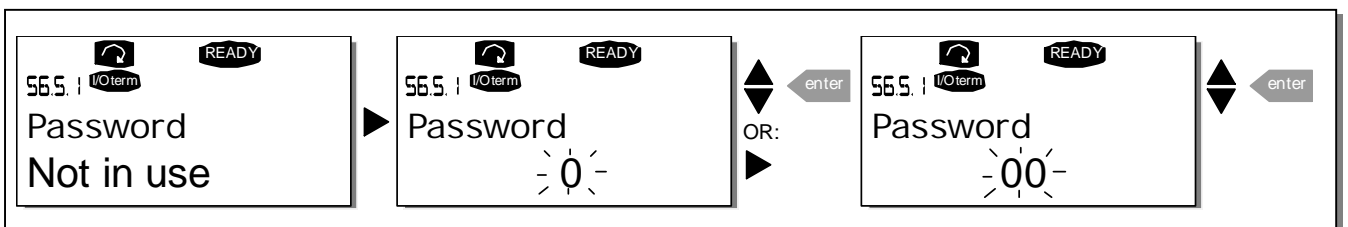

Figure 7-10. Password setting

Note! Store the password in a safe place! No changes can be made unless a valid password is entered.

Parameter lock (P6.5.2)

This function allows the user to prohibit changes to the parameters.

If the parameter lock is activated, the text **locked** will appear on the display if you try to edit a parameter value.

NOTE: This function does not prevent unauthorised editing of parameter values.

Enter the edit mode by pressing *Menu button right*. Use the *Browser buttons* to change the parameter lock status. Confirm the change with the *enter* button or go back to the previous level by pressing *Menu button left*.

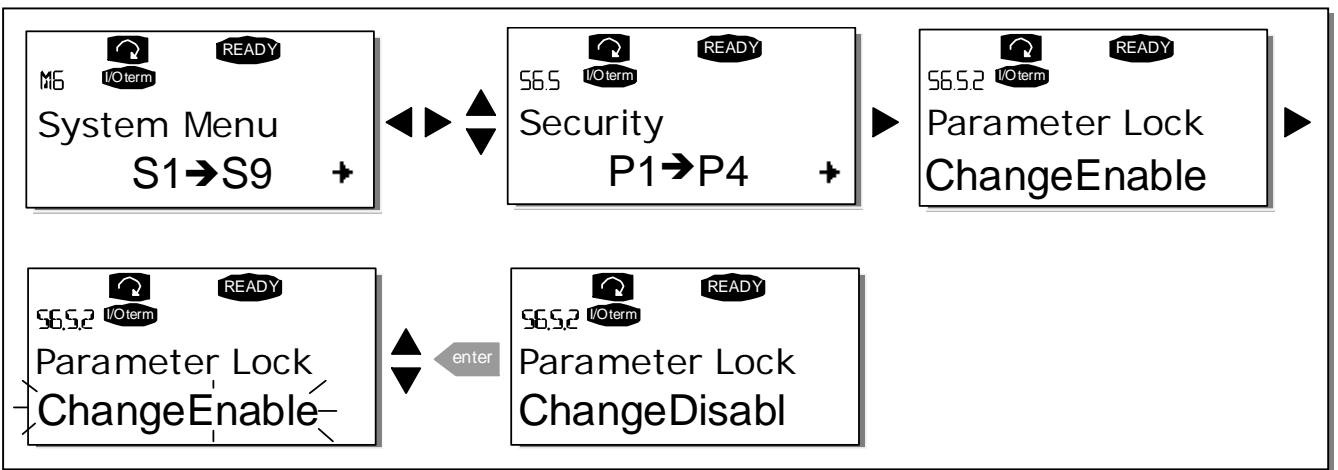

Figure 7-11. Parameter locking

Start-up wizard (P6.5.3)

The Start-up wizard facilitates the commissioning of the inverter. If active, the Start-up wizard prompts the operator for the language and application of his/her choice and then displays the first menu or page.

Activating the Start-up wizard: In the System Menu, find page P6.5.3. Press *Menu button right* once to enter the edit mode. Use the *Browser buttons* to select *Yes* and confirm the selection with the *enter* button. If you want to deactivate the function, follow the same procedure and give the parameter value *No*.



Figure 7-12. Activation of Start-up wizard

Multimonitoring items (P6.5.4)

Vacon alphanumeric keypad features a display where you can monitor up to three actual values at the same time (see Chapter 7.3.1 and Chapter *Monitoring values* in the manual of the application you are using). On page P6.5.4 of the System Menu, you can define whether the operator can replace the values monitored with other values. See below.

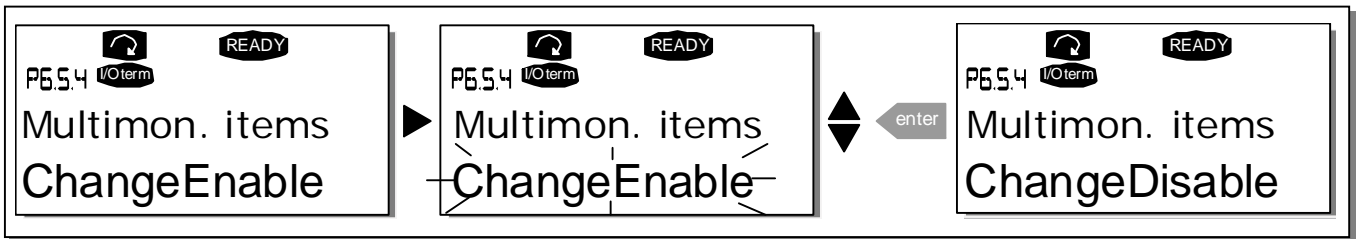

Figure 7-13. Disabling the change of multimonitoring items

7.3.6.6 Keypad settings

In the Keypad settings submenu under the System menu, you can further customise your inverter operator interface.

Locate the Keypad setting submenu (S6.6). Under the submenu, there are four pages (P#) associated with the keypad operation:

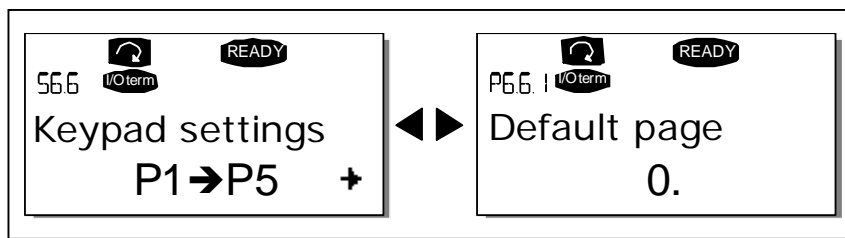

Figure 7-14. Keypad settings submenu

Default page (P6.6.1)

Here you can set the location (page) to which the display automatically moves when the *Timeout time* (see below) has expired or the power is switched on to the keypad.

If the *Default page* is 0, the function is not activated i.e. the latest displayed page remains on the keypad display. Pressing *Menu button right* takes you to the edit mode. Change the number of the Main menu with the *Browser buttons*. To edit the number of the submenu/page, press *Menu button right*. If the page you want to move to by default is at the third level, repeat the procedure. Confirm the new default page with the *enter* button. You can return to the previous menu at any time by pressing *Menu button left*.

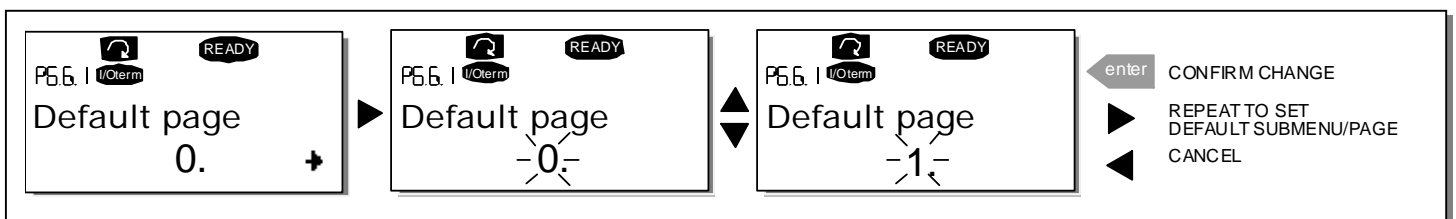

Figure 7-15. Default page function

Default page in the operating menu (P6.6.2)

Here you can set the location (page) in the *Operating menu* (in special applications only) to which the display automatically moves to when the set *Timeout time* (see below) has expired or the power is switched on to the keypad.

See how to set the Default page in the above figure.

Timeout time (P6.6.3)

The Timeout time setting defines the time after which the keypad display returns to the Default page (P6.6.1). (See previous page.)

Enter the edit mode by pressing *Menu button right*. Set the desired timeout time and confirm it with the *enter* button. You can return to the previous menu at any time by pressing *Menu button left*.

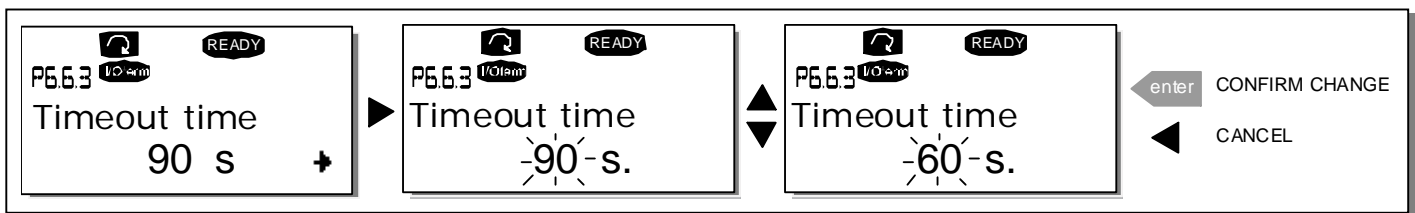

Figure 7-16. Timeout time setting

Note: If the *Default page* value is 0 the *Timeout time* setting has no effect.

Contrast adjustment (P6.6.4)

In case the display is unclear, you can adjust its contrast through the same procedure as for the timeout time setting (see above).

Backlight time (P6.6.5)

By giving a value for the *Backlight time*, you can determine how long the backlight stays on before going out. You can select any time between 1 and 65535 minutes or 'Forever'. For the value setting procedure, see Timeout time (P6.6.3).

7.3.6.7 *Hardware settings*

NOTE: *The Hardware settings submenu is protected with a password. Store the password in a safe place!*

In the *Hardware settings* submenu (S6.7) under the System menu, you can further control some functions of the hardware in your inverter. The functions available in this menu are ***Internal brake resistor connection, Fan control, HMI acknowledge timeout and HMI retry.***

Internal brake resistor connection (P6.7.1)

This function tells the inverter, whether the internal brake resistor is connected or not. If you have ordered the inverter with an internal brake resistor, the default value of this parameter is *Connected*. However, if it is necessary to increase braking capacity by installing an external brake resistor, or if the internal brake resistor is disconnected for another reason, it is advisable to change the value of this function to *Not conn.* in order to avoid unnecessary fault trips.

Enter the edit mode by pressing *Menu button right*. You can change the brake resistor information with the *Browser buttons*. Confirm the change with the *enter* button or return to the previous level with *Menu button left*.

Note! The brake resistor is available as optional equipment for all classes. It can be installed internally in classes FR4 to FR6.

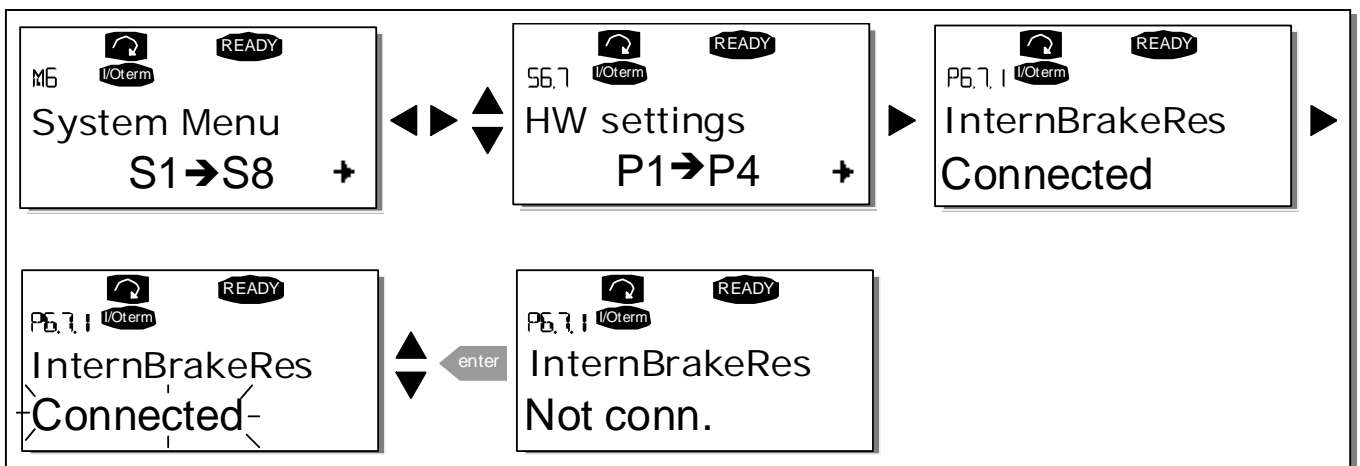

Figure 7-17. Internal brake resistor connection

Fan control (P6.7.2)

This function allows you to control the cooling fan of the inverter. You can set the fan to run continuously when the power is switched on or depending on the temperature of the unit. If the latter function has been selected, the fan is switched on automatically when the heatsink temperature reaches 60°C. The fan receives a stop command when the heatsink temperature falls to 55°C. After the command, the fan runs for approximately 1 minute before stopping. The same happens after switching on the power and after changing the value from *Continuous* to *Temperature*.

Note! The fan runs always when the drive is in RUN state.

To change the value: Enter the edit mode by pressing *Menu button right*. The value starts blinking. Use the *Browser buttons* to change the fan mode and confirm the change with the *enter* button. If you do not want to change the value, return to the previous level with *Menu button left*. See Figure 7.21 .

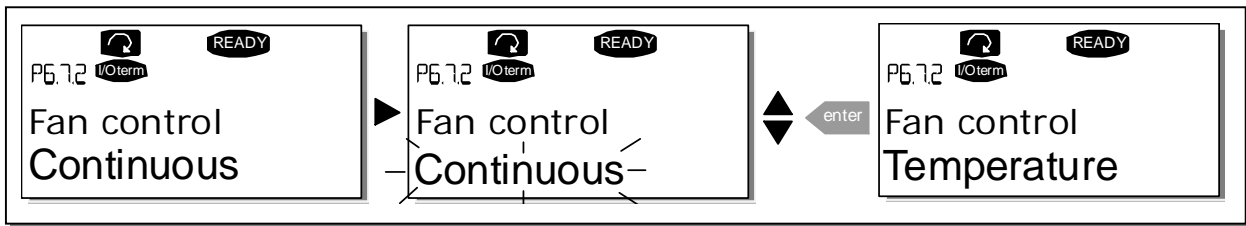

Figure 7-18. Fan control function

HMI acknowledge timeout (P6.7.3)

This function allows the user to change the timeout of the HMI acknowledgement time. The inverter waits for the HMI acknowledgment in accordance with the value of this parameter.

Note! If the inverter has been connected to the PC with a normal cable, the default values of parameters 6.7.3 and 6.7.4 (200 and 5) **must not be changed**.

If the inverter has been connected to the PC via a modem and there is a delay in transferring messages, the value of parameter 6.7.3 must be set according to the delay as follows:

Example:

- Transfer delay between the inverter and the PC = 600 ms
- The value of par. 6.7.3 is set to 1200 ms (2 x 600, sending delay + receiving delay)
- The corresponding setting shall be entered in the [Misc] part of the file NCDrive.ini:
 - Retries = 5
 - AckTimeOut = 1200
 - TimeOut = 6000
- It must also be considered that intervals shorter than the AckTimeOut time cannot be used in NC-Drive monitoring.

Enter the edit mode by pressing *Menu button right*. The current value starts to blink. Use the *Browser buttons* to change the acknowledgement time. Confirm the change with the *enter* button or return to the previous level with *Menu button left*.

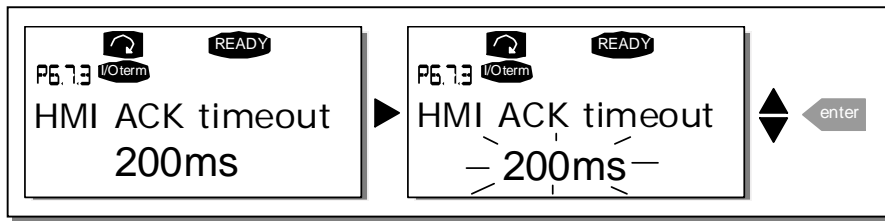

Figure 7-19. HMI acknowledge timeout

Number of retries to receive HMI acknowledgement (P6.7.4)

With this parameter you can set the number of times the drive will try to receive acknowledgement if it does not receive acknowledgement within the acknowledgement time (P6.7.3) or if the received acknowledgement is faulty.

You can change value through the same procedure as for P6.7.3 (see above).

Note! Changes to P6.7.3 and P6.7.4 become effective after the next start-up.

7.3.6.8 System info

In the *System info* submenu (S6.8) you can find inverter-related hardware and software information.

You can enter the *System info* submenu by pressing [Menu button right](#). You can now browse the submenu pages with the [Browser buttons](#).

Total counters

The *Total counters menu* (S6.8.1) contains information on the inverter operation times i.e. the total number of MWh, operation days and operation hours. Unlike the counters in the Trip counters menu, these counters cannot be reset.

Note! The Power On time counter (days and hours) runs always when the power is on.

Page	Counter
C6.8.10.1	MWh counter
C6.8.10.2	Operation day counter
C6.8.1.3.	Operation hour counter

Table 7-5. Counter pages

Trip counters

Trip counters (menu S6.8.2) are counters the values of which can be reset i.e. restored to zero. You can use the following resettable counters:

Note! The trip counters run only when the motor is running.

Page	Counter
T6.8.2.1	MWh counter
T6.8.2.3	Operation day counter
T6.8.2.4	Operation hour counter

Table 7-6. Resettable counters

The counters can be reset on pages 6.8.2.2 (Clear MWh counter) and 6.8.2.5 (Clear Operation time counter).

Example: When you want to reset the operation counters you should do the following:

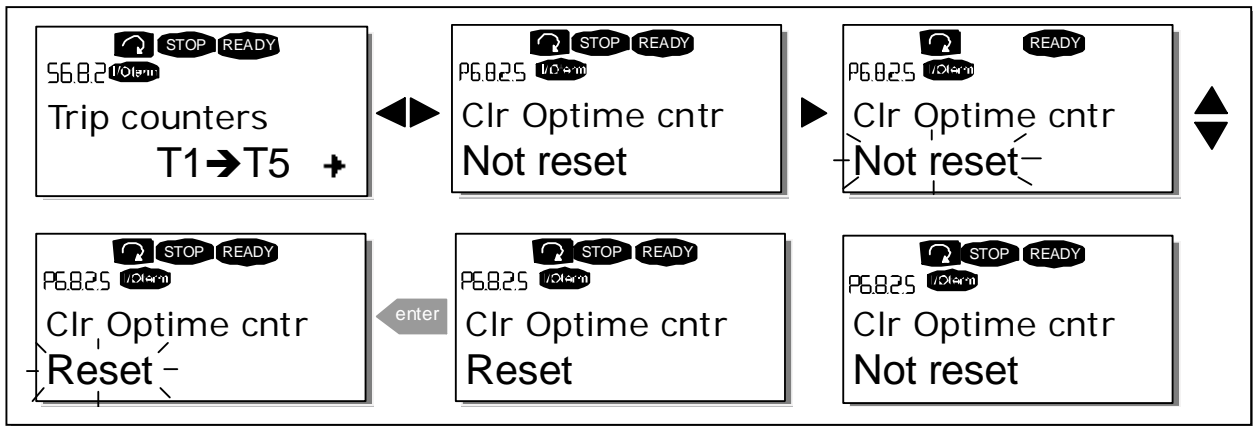

Figure 7-20. Counter reset

Software (S6.8.3)

The Software information page includes information on the following inverter software related topics:

Page	Content
6.8.3.1	Software package
6.8.3.2	System software version
6.8.3.3	Firmware interface
6.8.3.4	System load

Table 7-7. Software information pages

Applications (S6.8.4)

At location S6.8.4, you can find the Applications submenu containing information on the application currently in use and all other applications loaded into the inverter. The following information is available:

Page	Content
6.8.4.#	Name of application
6.8.4.#.1	Application ID
6.8.4.#.2	Version
6.8.4.#.3	Firmware interface

Table 7-8. Applications information pages

In the Applications information page, press *Menu button right* to enter the Application pages of which there are as many as there are applications loaded into the inverter. Locate the desired application with the *Browser buttons* and then enter the Information pages with *Menu button right*. Use the *Browser buttons* to see the different pages.

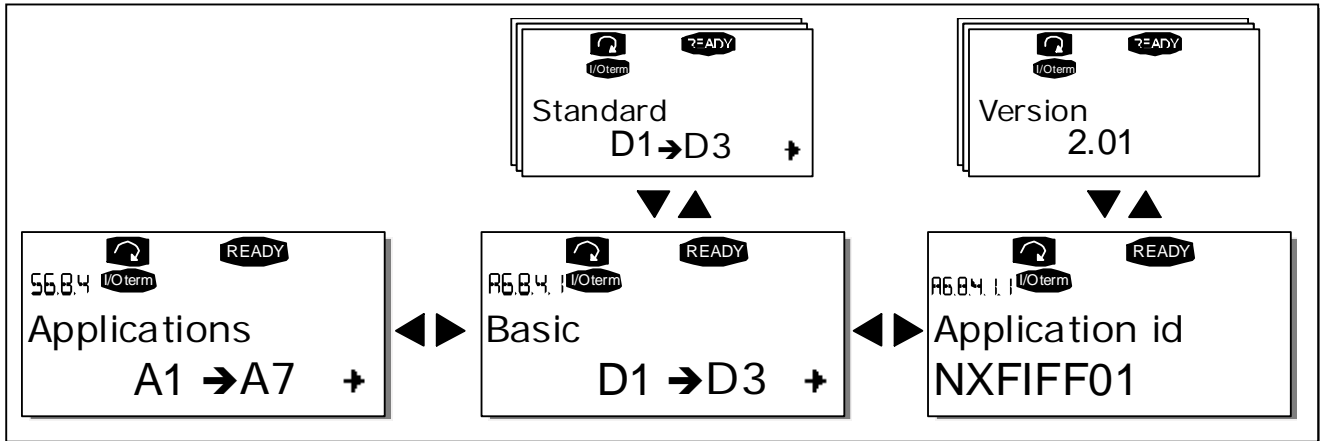

Figure 7-21. Applications info submenu

Hardware (S6.8.5)

The *Hardware* information page provides information on the following hardware-related topics:

Page	Content
6.8.5.1	Nominal power of the unit
6.8.5.2	Nominal voltage of the unit
6.8.5.3	Brake chopper
6.8.5.4	Brake resistor

Table 7-9. Hardware information pages

Expander boards (S6.8.6)

The *Expander boards submenu* contains information about the basic and option boards. (See Chapter 6.2)

You can check the status of each board slot by entering the Expander boards page with *Menu button right*. Use the *Browser buttons* to view the status of each board slot. The description line of the keypad will display the type of the expansion board and the text 'Run' is shown below it. If no board is connected to the slot the text 'no board' will be shown. If a board is connected to a slot but the connection is lost for some reason, the text 'no conn.' is displayed. For more information, see Chapter 6.2, Figure 6-13.

For more information on expander board related parameters, see Chapter 7.3.7.

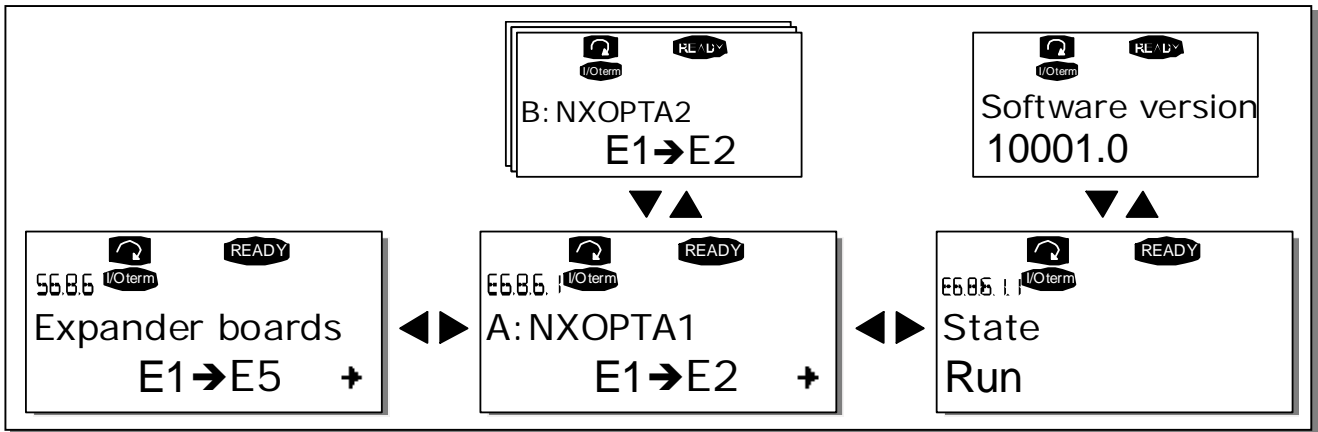

Figure 7-22. Expander board information menus

7.3.7 Expander board menu (M7)

In the *Expander board menu* the user can 1) see the expander boards connected to the control board and 2) see and edit the parameters associated with the expander boards.

Go to the next menu level (G#) with *Menu button right*. At this level, you can browse through slots A to E (see page 52) with the *Browser buttons* to see which expander boards are connected to the control board. On the lowermost line of the display, you will also see the number of parameters associated with the board. You can view and edit the parameter values as described in Chapter 7.3.2. See Table 7-10 and Figure 7-23.

Expander board parameters

Code	Parameter	Min	Max	Default	Cust	Selections
P7.1.1.1	AI1 mode	1	5	3		1=0...20 mA 2=4...20 mA 3=0...10 V 4=2...10 V 5=-10...+10 V
P7.1.1.2	AI2 mode	1	5	1		See P7.1.1.1
P7.1.1.3	AO1 mode	1	4	1		1=0...20 mA 2=4...20 mA 3=0...10 V 4=2...10 V

Table 7-10. Expander board parameters (board OPT-A1)

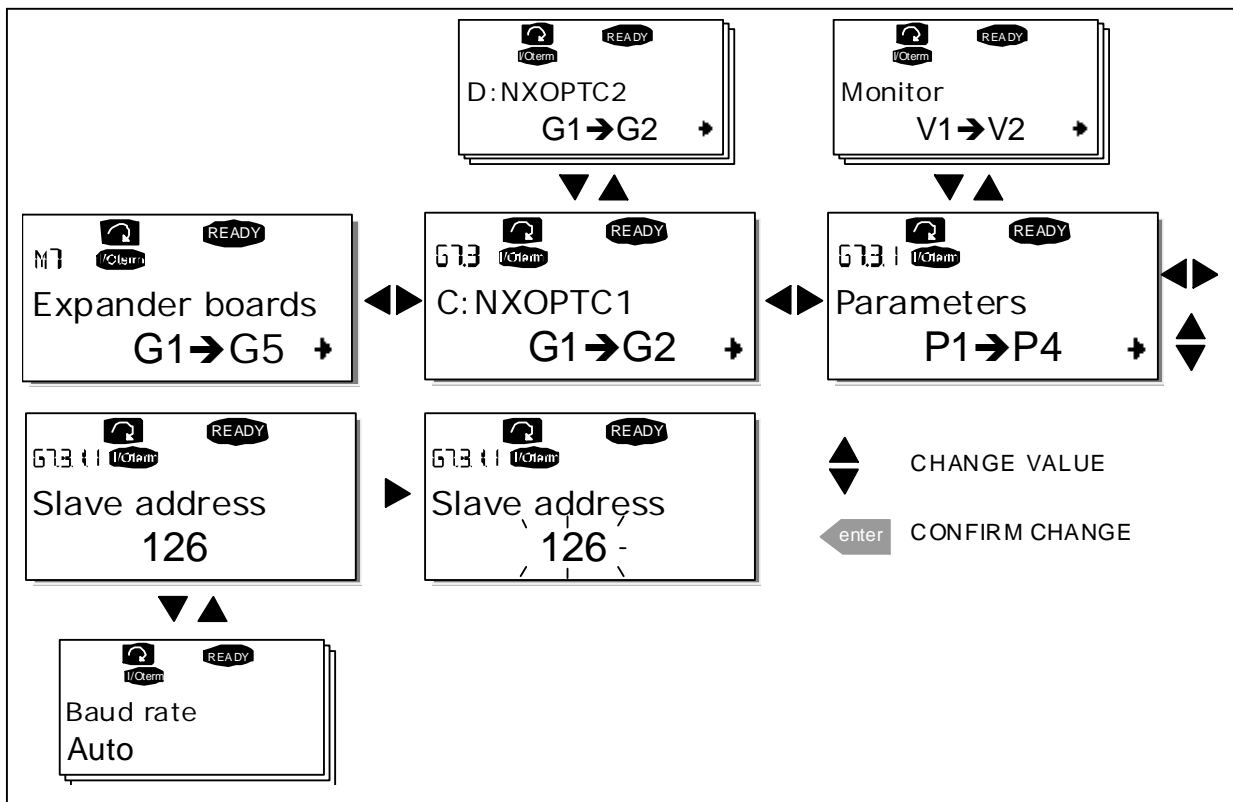

Figure 7-23. Expander board information menu



7.4 Further keypad functions

The Vacon NX control keypad contains additional application-related functions. See Vacon NX Application Package for more information.

8. COMMISSIONING

8.1 Safety

Before commissioning, note the following directions and warnings:

	1	Internal components and circuit boards of the inverter (except for the galvanically isolated I/O terminals) are live when Vacon NX is connected to mains potential. Coming into contact with this voltage is extremely dangerous and may cause death or severe injury.
	2	The motor terminals U, V, W and the DC-, DC+ terminals are live when Vacon NX inverter is connected to DC supply, even if the motor is not running.
	3	The control I/O-terminals are isolated from the mains potential. However, the relay outputs and other I/O-terminals may have a dangerous control voltage present even when Vacon NX is disconnected from DC supply.
	4	Do not make any connections when the inverter is connected to the DC supply.
	5	After having disconnected the inverter, wait until the fan stops and the indicators on the keypad go out (if no keypad is attached see the indicator through the keypad base). Wait 5 more minutes before doing any work on Vacon NX connections. Do not open the cover before the time has expired.
	6	Before connecting the inverter to DC supply make sure that the Vacon NX front cover is closed.
	7	When running, the side of inverter FR8 is burning hot. Do not touch it with bare hands!

8.2 Commissioning the inverter

- 1 Read carefully the safety instructions in Chapter 1 and above and follow them.
- 2 After the installation, make sure that:
 - both the inverter and the motor are grounded
 - the DC supply and motor cables comply with the requirements given in Chapter 6.1.1.1.
 - the control cables are located as far as possible from the power cables (see Chapter 6.1.1.8, step 2) and the shields of the shielded cables are connected to protective earth . The wires may not touch the electrical components of the inverter.
 - the common inputs of digital input groups are connected to +24V or ground of the I/O terminal or the external supply.
- 3 Check the quality and quantity of cooling air (See Chapter 5.2 and Table 5-1).
- 4 Check the inside of the inverter for condensation.
- 5 Check that all Start/Stop switches connected to the I/O terminals are in **Stop** position.
- 6 Connect the inverter to DC supply.

- 7 Set the parameters of group 1 according to the requirements of your application (See Vacon All in One Application Manual). At least the following parameters should be set:
- motor nominal voltage
 - motor nominal frequency
 - motor nominal speed
 - motor nominal current

You will find the values needed for the parameters on the motor rating plate.

8 Perform run test **without motor**

Perform either Test A or Test B:

A Controls from the I/O terminals:

Turn the Start/Stop switch to ON position.

Change the frequency reference (potentiometer)

*Check in the Monitoring menu **M1** that the value of Output frequency changes according to the change of frequency reference.*

Turn the Start/Stop switch to OFF position.

B Control from the control keypad:

Change the control from the I/O terminals to the keypad as advised in Chapter 7.3.3.1.

*Press the **START** button on the keypad .*

*Move over to the **Keypad control menu M3** and Keypad Reference submenu (see Chapter*

*7.3.3.2) and change the frequency reference with the **Browser buttons**  .*

*Check in **Monitoring menu M1** that the value of Output frequency changes according to the change of frequency reference.*

*Press the **STOP** button on the keypad .*

- 9 Run the start-up tests without the motor being connected to the process. If this is not possible, make sure that running each test is safe prior to running it. Inform your co-workers of the tests.
 - a) *Switch off the DC supply voltage and wait until the drive has stopped as advised in Chapter 8.1, step 5.*
 - b) *Connect the motor cable to the motor and to the motor cable terminals of the inverter.*
 - c) *Make sure that all Start/Stop switches are in Stop positions.*
 - d) *Switch the supply voltage ON*
 - e) *Repeat test 8A or 8B.*

- 10 Connect the motor to the process (if the start-up test was run without the motor being connected)
 - a) *Before running the tests, make sure that this can be done safely.*
 - b) *Inform your co-workers of the tests.*
 - c) *Repeat test 8A or **8B**.*

9. FAULT TRACING

When a fault is detected by the inverter control electronics, the drive is stopped and the symbol F together with the ordinal number of the fault, the fault code and a short fault description appear on the display. The fault can be reset with the *reset* button on the control keypad or via the I/O terminal. The faults are stored in the Fault history menu M5, which can be browsed. The table below contains all the fault codes.

The fault codes, their causes and correcting actions are presented in the table below. Shaded faults are A faults only. The items in white on black background present faults for which you can program different responses in the application, see parameter group Protections.

Fault code	Fault	Possible cause	Correcting measures
1	Overcurrent	Inverter has detected too high a current (>4*I _n) in the motor cable: sudden heavy load increase short circuit in motor cables unsuitable motor	Check loading. Check motor. Check cables.
2	Overvoltage	The DC-link voltage has exceeded the limits defined in too short a deceleration time high overvoltage spikes in supply	Set the deceleration time longer. Add a brake chopper or a brake resistor.
3	Earth fault	Current measurement has detected that the sum of motor phase current is not zero. insulation failure in cables or motor	Check motor cable and motor.
5	Charging switch	The charging switch is open, when the START command has been given. faulty operation component failure	Reset the fault and restart. Should the fault re-occur, contact the distributor near to you. Please visit: http://www.vacon.com/wwcontacts.html
6	Emergency stop	Stop signal has been given from the option board.	
7	Saturation trip	Various causes: component failure brake resistor short-circuit or overload	Cannot be reset from the keypad. Switch off power. DO NOT RE-CONNECT POWER! Contact factory. If this fault appears simultaneously with Fault 1, check motor cables and motor
8	System fault	component failure faulty operation Note the exceptional Fault data record. See 7.3.4.3.	Reset the fault and restart. Should the fault re-occur, contact the distributor near to you. Please visit: http://www.vacon.com/wwcontacts.html
9	Undervoltage	DC-link voltage is under the voltage limits defined in most probable cause: too low a supply voltage inverter internal fault	In case of temporary supply voltage break reset the fault and restart the inverter. Check the supply voltage. If it is adequate, an internal failure has occurred. Contact the nearest Vacon distributor. Please visit: http://www.vacon.com/wwcontacts.html
10	Input line supervision	Input line phase is missing.	Check supply voltage and cable.

11	Output phase supervision	Current measurement has detected that there is no current in one motor phase.	Check motor cable and motor.
12	Brake chopper supervision	no brake resistor installed brake resistor is broken brake chopper failure	Check brake resistor. If the resistor is ok, the chopper is faulty. Contact the nearest Vacon distributor. Please visit: http://www.vacon.com/wwcontacts.html
13	Inverter undertemperature	Heatsink temperature is under -10°C	
14	Inverter overtemperature	Heatsink temperature is over 90°C or 77°C (NX_6, FR6). Overtemperature warning is issued when the heatsink temperature exceeds 85°C (72°C).	Check the correct amount and flow of cooling air. Check the heatsink for dust. Check the ambient temperature. Make sure that the switching frequency is not too high in relation to ambient temperature and motor load.
15	Motor stalled	Motor stall protection has tripped.	Check motor.
16	Motor over-temperature	Motor overheating has been detected by inverter motor temperature model. Motor is overloaded.	Decrease the motor load. If no motor overload exists, check the temperature model parameters.
17	Motor underload	Motor underload protection has tripped.	
22	EEPROM checksum fault	Parameter save fault faulty operation component failure	
24	Counter fault	Values displayed on counters are incorrect	
25	Microprocessor watchdog fault	faulty operation component failure	Reset the fault and restart. Should the fault re-occur, contact the distributor near to you. Please visit: http://www.vacon.com/wwcontacts.html
26	Start-up prevented	Start-up of the drive has been prevented.	Cancel prevention of start-up.
29	Thermistor fault	The thermistor input of option board has detected increase of the motor temperature	Check motor cooling and loading Check thermistor connection (If thermistor input of the option board is not in use it has to be short circuited)
31	IGBT temperature (hardware)	IGBT Inverter Bridge overtemperature protection has detected too high a short term overload current	Check loading. Check motor size.
32	Fan cooling	Cooling fan of the inverter does not start, when ON command is given	Contact the nearest Vacon distributor. Please visit: http://www.vacon.com/wwcontacts.html
34	CAN bus communication	Sent message not acknowledged.	Ensure that there is another device on the bus with the same configuration.
36	Control unit	NXS Control Unit can not control NXP Power Unit and vice versa	Change control unit
37	Device changed (same type)	Option board or control unit changed. Same type of board or same power rating of drive.	Reset Note: No fault time data record!
38	Device added (same type)	Option board or drive added. Drive of same power rating or same type of board added.	Reset Note: No fault time data record!

39	Device removed	Option board removed. Drive removed.	Reset Note: No fault time data record!
40	Device unknown	Unknown option board or drive.	Contact the nearest Vacon distributor. Please visit: http://www.vacon.com/wwcontacts.html
41	IGBT temperature	IGBT Inverter Bridge overtemperature protection has detected too high a short term overload current	Check loading. Check motor size.
42	Brake resistor overtemperature N/A	Brake resistor overtemperature protection has detected too heavy braking	Set the deceleration time longer. Use external brake resistor.
43	Encoder fault	Note the exceptional Fault data record. See 7.3.4.3. Additional codes: 1 = Encoder 1 channel A is missing 2 = Encoder 1 channel B is missing 3 = Both encoder 1 channels are missing 4 = Encoder reversed	Check encoder channel connections. Check the encoder board.
44	Device changed (different type)	Option board or control unit changed. Option board of different type or different power rating of drive.	Reset Note: No fault time data record! Note: Application parameter values restored to default.
45	Device added (different type)	Option board or device added Option board of different type or drive of different power rating added.	Reset Note: No fault time data record! Note: Application parameter values restored to default.
50	Analogue input I_{in} < 4mA (sel. signal range 4 to 20 mA)	Current at the analogue input is < 4mA. control cable is broken or loose signal source has failed	Check the current loop circuitry.
51	External fault	Digital input fault.	
52	Keypad communication fault	There is no connection between the control keypad and the inverter.	Check keypad connection and possible keypad cable.
53	Fieldbus fault	The data connection between the fieldbus Master and the fieldbus board is broken	Check installation. If installation is correct contact the nearest Vacon distributor. Please visit: http://www.vacon.com/wwcontacts.html
54	Slot fault	Defective option board or slot	Check board and slot. Contact the nearest Vacon distributor. Please visit: http://www.vacon.com/wwcontacts.html
56	PT100 board temp. fault	Temperature limit values set for the PT100 board parameters have been exceeded	Find the cause of temperature rise

Table 9-1. Fault codes

Vaasa

Vacon Plc (Head office and production)
Runsorintie 7
65380 Vaasa
firstname.lastname@vacon.com
telephone: +358 (0)201 2121
fax: +358 (0)201 212 205

Helsinki

Vacon Plc
Äyritie 12
01510 Vantaa
telephone: +358 (0)201 212 600
fax: +358 (0)201 212 699

Tampere

Vacon Plc
Vehnämyllynkatu 18
33700 Tampere
telephone: +358 (0)201 2121
fax: +358 (0)201 212 750

Vacon Traction Oy

Vehnämyllynkatu 18
33700 Tampere
telephone: +358 (0)201 2121
fax: +358 (0)201 212 710

SALES COMPANIES AND REPRESENTATIVE OFFICES:**Austria**

Vacon AT Antriebssysteme GmbH
Aumühlweg 21
2544 Leobersdorf
telephone: +43 2256 651 66
fax: +43 2256 651 66 66

Belgium

Vacon Benelux NV/SA
Interleuvenlaan 62
3001 Heverlee (Leuven)
telephone: +32 (0)16 394 825
fax: +32 (0)16 394 827

France

Vacon France s.a.s.
1 Rue Jacquard – BP72
91280 Saint Pierre du Perray CDIS
telephone: +33 (0)1 69 89 60 30
fax: +33 (0)1 69 89 60 40

Germany

Vacon GmbH
Gladbecker Strasse 425
45329 Essen
telephone: +49 (0)201 806 700
fax: +49 (0)201 806 7099

Great Britain

Vacon Drives (UK) Ltd.
18, Maizefield
Hinckley Fields Industrial Estate
Hinckley
LE10 1YF Leicestershire
telephone: +44 (0)1455 611 515
fax: +44 (0)1455 611 517

Italy

Vacon S.p.A.
Via F.lli Guerra, 35
42100 Reggio Emilia
telephone: +39 0522 276811
fax: +39 0522 276890

The Netherlands

Vacon Benelux BV
Weide 40
4206 CJ Gorinchem
telephone: +31 (0)183 642 970
fax: +31 (0)183 642 971

Norway

Vacon AS
Langgata 2
3080 Holmestrand
telephone: +47 330 96120
fax: +47 330 96130

PR China

Vacon Suzhou Drives Co. Ltd.
Building 13CD
428 Xinglong Street
Suchun Industrial Square
Suzhou 215126
telephone: +86 512 6283 6630
fax: +86 512 6283 6618

Vacon Suzhou Drives Co. Ltd.
Beijing Office
A205, Grand Pacific Garden Mansion
8A Guanhua Road
Beijing 100026
telephone: +86 10 6581 3734
fax: +86 10 6581 3754

Russia

ZAO Vacon Drives
Bolshaja Jakimanka 31,
stroenie 18
109180 Moscow
telephone: +7 (095) 974 14 47
fax: +7 (095) 974 15 54

ZAO Vacon Drives
2ya Sovetskaya 7, office 210A
191036 St. Petersburg
telephone: +7 (812) 332 1114
fax: +7 (812) 279 9053

Singapore

Vacon Plc
Singapore Representative Office
102F Pasir Panjang Road
#02-06 Citilink Warehouse Complex
Singapore 118530
telephone: +65 6278 8533
fax: +65 6278 1066

Spain

Vacon Drives Ibérica S.A.
Miquel Servet, 2. P.I. Bufalvent
08243 Manresa
telephone: +34 93 877 45 06
fax: +34 93 877 00 09

Sweden

Vacon AB
Torget 1
172 67 Sundbyberg
telephone: +46 (0)8 293 055
fax: +46 (0)8 290 755