

VACON[®] 100 FLOW
AC DRIVES

APPLICATION MANUAL

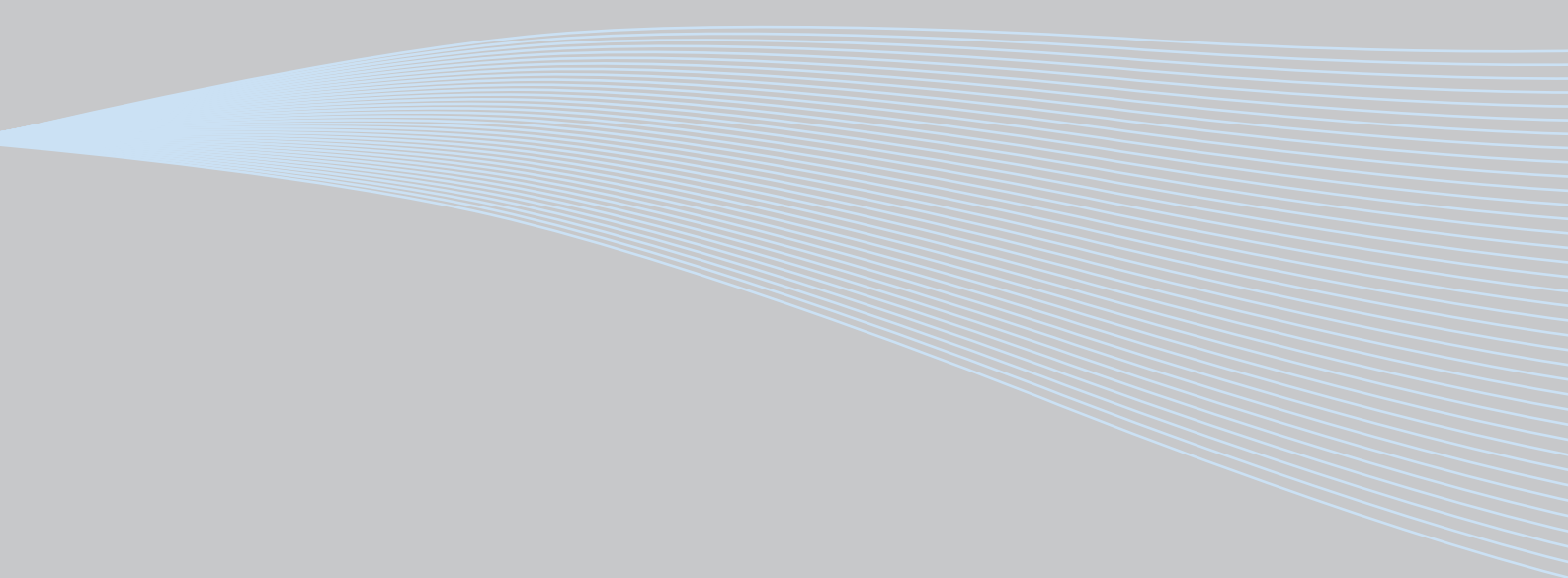

TABLE OF CONTENTS

Document: DPD01083B

Version release date: 4.3.13

Corresponds to software package FW0159V002.vcx

1. Vacon®100 FLOW - Quick startup guide	6
1.1 Keypad of Vacon®100 FLOW	6
1.1.1 Keypad buttons	6
1.1.2 Display	6
1.2 First startup.....	8
1.3 Fire mode wizard.....	10
1.4 Application wizards	11
1.4.1 Standard and HVAC application wizards	12
1.4.2 PID control application wizard	12
1.4.3 Multipump (single drive) application wizard.....	14
1.4.4 Multipump (multidrive) application wizard	16
1.5 Description of the applications	18
1.5.1 Standard and HVAC applications	18
1.5.2 PID control application.....	23
1.5.3 Multipump (single drive) application	29
1.5.4 Multipump (multidrive) application.....	38
2. User interfaces on Vacon®100 FLOW	49
2.1 Navigation on keypad	49
2.2 Vacon graphical keypad	51
2.2.1 Using the graphical keypad.....	51
2.3 Vacon text keypad.....	59
2.3.1 Keypad display.....	59
2.3.2 Using the text keypad	60
2.4 Menu structure.....	63
2.4.1 Quick setup.....	64
2.4.2 Monitor	64
2.5 Vacon Live.....	66
3. Monitoring menu	67
3.1 Monitor group.....	67
3.1.1 Multimonitor	67
3.1.2 Trend curve	67
3.1.3 Basic	70
3.1.4 I/O	71
3.1.5 Temperature inputs	71
3.1.6 Extras and advanced	72
3.1.7 Timer functions monitoring	75
3.1.8 PID controller monitoring	75
3.1.9 External PID controller monitoring	76
3.1.10 Multipump monitoring	76
3.1.11 Maintenance counters.....	77
3.1.12 Fieldbus data monitoring	78
4. Parameters menu.....	79
4.1 Group 3.1: motor settings	79
4.1.1 Motor nameplate parameters.....	79
4.1.2 Motor control settings.....	80
4.1.3 Motor limit settings.....	81
4.1.4 Open loop settings.....	82
4.2 Group 3.2: Start/Stop setup	84

4.3	Group 3.3: references	85
4.3.1	Frequency reference parametersj.....	85
4.3.2	Preset frequencies	87
4.3.3	Motor potentiometer parameters	88
4.4	Group 3.4: ramps and brakes setup	89
4.4.1	Ramp 1 setup.....	89
4.4.2	Ramp 2 setup.....	89
4.4.3	Start magnetisation parameters	90
4.4.4	DC brake parameters.....	90
4.4.5	Flux braking parameters	90
4.5	Group 3.5: I/O configuration.....	91
4.5.1	Digital input settings	91
4.5.2	Analogue inputs.....	93
4.5.3	Digital outputs, slot B (standard)	95
4.5.4	Expander slots C, D and E digital outputs	96
4.5.5	Analogue outputs, Slot A (standard)	97
4.5.6	Expander slots D to E analogue outputs.....	98
4.6	Group 3.6: fieldbus data mapping	99
4.7	Group 3.7: prohibit frequencies	100
4.8	Group 3.8: supervisions.....	100
4.9	Group 3.9: protections.....	102
4.9.1	General protections settings.....	102
4.9.2	Motor thermal protections settings.....	103
4.9.3	Motor stall protection settings	103
4.9.4	Underload (dry pump) protection settings.....	104
4.9.5	Quick stop settings	104
4.9.6	Temperature input fault 1 settings	105
4.9.7	Temperature input fault 2 settings	106
4.9.8	AI low protection	107
4.10	Group 3.10: automatic reset	108
4.11	Group 3.11: application settings	109
4.12	Group 3.12: timer functions	110
4.13	Group 3.13: PID controller 1	112
4.13.1	Basic settings	112
4.13.2	Setpoints.....	115
4.13.3	Feedback settings	117
4.13.4	Feedforward settings	118
4.13.5	Sleep function Settings	119
4.13.6	Feedback Supervision parameters	119
4.13.7	Pressure loss compensation parameters	120
4.13.8	Soft fill Settings	121
4.13.9	Input pressure supervision	122
4.13.10	Sleep - no demand detection	123
4.14	Group 3.14: external PID controller.....	124
4.14.1	Basic settings for external PID controller	124
4.14.2	External PID controller, setpoints	125
4.14.3	Feedbacks	126
4.14.4	Feedback supervision	126
4.15	Group 3.15: multipump	127
4.15.1	Multipump parameters	127
4.15.2	Interlock signals.....	128
4.15.3	Overpressure supervision parameters.....	130
4.15.4	Pump running time counters.....	130
4.16	Group 3.16: maintenance counters.....	131

4.17	Group 3.17: fire mode.....	132
4.18	Group 3.18: motor preheat parameters	133
4.19	Group 3.21: pump control	134
4.19.1	Auto-cleaning parameters	134
4.19.2	Jockey pump parameters	135
4.19.3	Priming pump parameters	135
4.19.4	Anti-blocking parameters	135
4.19.5	Frost protection parameters	137
5.	Diagnostics menu	139
5.1	Active faults	139
5.2	Reset faults	139
5.3	Fault history	139
5.4	Total counters	140
5.5	Trip counters	142
5.6	Software info	142
6.	I/O and hardware menu	143
6.1	Basic I/O	143
6.2	Option board slots	144
6.3	Real time clock.....	144
6.4	Power unit settings	145
6.5	Keypad	146
6.6	Fieldbus	147
7.	User settings, favourites and user level menus	148
7.1	User settings	148
7.1.1	Parameter backup.....	148
7.2	Favourites	149
7.3	User levels.....	149
8.	Parameter descriptions.....	151
8.1	Motor settings	152
8.1.1	I/F start function.....	160
8.2	Start/Stop setup	161
8.3	References	168
8.3.1	Frequency reference	168
8.3.2	Preset frequencies	168
8.3.3	Motor potentiometer parameters.....	170
8.3.4	Flushing parameters.....	171
8.4	Ramps and brakes setup	172
8.5	I/O configuration.....	174
8.5.1	Programming of digital and analogue inputs.....	174
8.5.2	Default assignments of programmable inputs.....	180
8.5.3	Digital inputs	181
8.5.4	Analogue inputs.....	181
8.5.5	Digital outputs	185
8.5.6	Analogue outputs	187
8.6	Prohibit frequencies.....	190
8.7	Supervisions	192
8.7.1	Motor thermal protections.....	192
8.7.2	Motor stall protection.....	195
8.7.3	underload (dry pump) protection	196
8.8	Automatic reset	200
8.9	Timer functions	201
8.10	PID controller 1	204

8.10.1 Feedforward	204
8.10.2 Sleep function.....	205
8.10.3 Feedback supervision	207
8.10.4 Pressure loss compensation	208
8.10.5 Soft fill	210
8.10.6 Sleep - no demand detection function.....	212
8.10.7 Input pressure supervision	214
8.11 Multipump function	215
8.11.1 Multipump (multidrive) commissioning checklist	215
8.11.2 System configuration	217
8.11.3 Interlocks.....	223
8.11.4 Feedback sensor connection in a multidrive system	223
8.11.5 Overpressure supervision	230
8.11.6 Pump running time counters	231
8.12 Maintenance counters.....	234
8.13 Fire mode	235
8.14 Motor preheat function	237
8.15 Pump control.....	238
8.15.1 Auto-cleaning	238
8.15.2 Jockey pump.....	240
8.15.3 Priming pump.....	241
8.15.4 Anti-blocking function	242
8.15.5 Frost protection.....	242
8.15.6 Counters	243
9. Fault tracing	248
9.1 Fault appears	248
9.2 Fault history	249
9.3 Fault codes	250
10. Appendix 1	259
10.1 Default parameter values according to the selected application	259

About this manual

This manual is copyright of Vacon Plc. All Rights Reserved.

This manual describes the features and use of Vacon® 100 FLOW. The manual has been compiled *in accordance with the menu structure of the drive* (chapters 1 and 3-7):

- **Chapter 1, Quick Startup Guide**, gives information on
 - How to get started with the keypad
 - How to select the application configuration
 - How to quickly set up the selected application
 - The applications with examples
- **Chapter 2, User Interfaces**, gives information on
 - The keypad in detail, the views, keypad types, etc.
 - Vacon Live
 - The onboard fieldbus functionality
- **Chapter 3, Monitoring menu**, gives detailed information on the monitoring values.
- **Chapter 4, Parameter menu** lists all the parameters of the drive
- **Chapter 5** presents the **Diagnostics menu**
- **Chapter 6** presents the **I/O and Hardware menu**
- **Chapter 7** presents the **User settings, favourites and user level menus**
- **Chapter 8, Parameter descriptions**, gives further information on
 - Parameters and their use
 - Digital and analogue input programming
 - Application-specific functions
- **Chapter 9, Fault tracing**, gives information on
 - The faults and their causes
 - Resetting the faults
- **Chapter 10, Appendix** gives information on the different default values of the applications

NOTE! This manual includes a large amount of parameter tables. Below you can find the column names and their explanations:

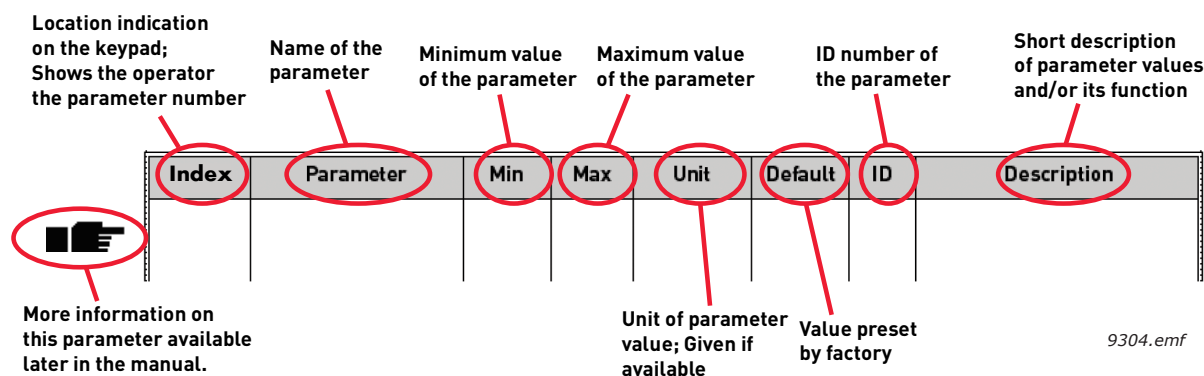

Figure 1.

Specific functions of Vacon® 100 FLOW AC drive

Features

- **Extensive wizards** for start-up, Standard, HVAC, PID-control, Multipump (Single drive and Multidrive) and Fire Mode used to facilitate commissioning
- **FUNCT button** for easy change between Local (keypad) and Remote control place. The remote control place is selectable by parameter (I/O or Fieldbus)
- **8 preset frequencies**
- **Motor potentiometer** functions
- **Flushing function**
- 2 programmable **ramp times**, 2 **supervisions** and 3 ranges of **prohibited frequencies**
- **Quick stop**
- **Control page** for easy operation and monitoring of the most essential values.
- **Fieldbus** data mapping
- **Automatic reset**
- Different **pre-heat modes** used to avoid condensation problems
- **Maximum output frequency 320Hz**
- **Real-time clock and timer functions** available (optional battery required). Possible to programme 3 time channels to achieve different functions on the drive (e.g. Start/ Stop and Preset frequencies)
- **External PID-controller** available. Can be used to control e.g. a valve using the AC drive's I/O
- **Sleep mode function** which automatically enables and disables drive running with user defined levels to save energy.
- **2-zone PID-controller** (2 different feedback signals; minimum and maximum control)
- **Two setpoint sources** for the PID-control. Selectable with digital input
- **PID setpoint boost function**
- **Feedforward function** to improve the response to the process changes
- **Process value supervision**
- **Multipump control** for Single drive and Multidrive systems
- **Multimaster and Multifollower** modes in Multidrive system
- **Real-time clock based multipump alternation**
- **Maintenance** counter
- **Pump control functions:** Autochange, Priming Pump Control, Jockey Pump Control, Pump Impeller Auto-Cleaning, Anti-blocking, Pump Input Pressure Supervision and Frost Protection function

1. VACON® 100 FLOW - QUICK STARTUP GUIDE

1.1 KEYPAD OF VACON® 100 FLOW

The control keypad is the interface between the Vacon® 100 AC drive and the user. With the control keypad it is possible to control the speed of a motor, to supervise the state of the equipment and to set the AC drive's parameters.

There are two keypad types you can choose for your user interface: *Keypad with graphical display* and *Text keypad*.

See a detailed description on operating the keypad in chapter 2.

1.1.1 KEYPAD BUTTONS

The button section of the keypad is identical for both keypad types:

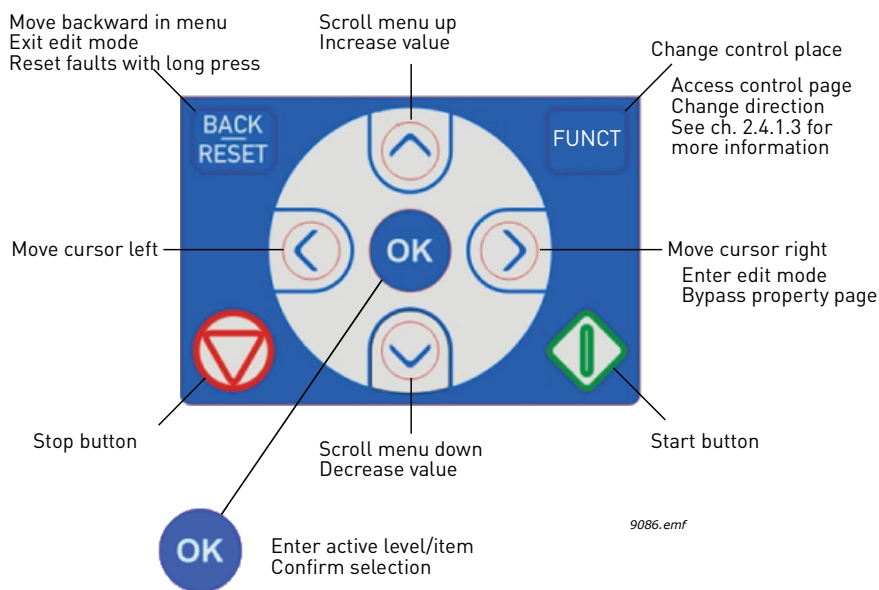

Figure 2.

1.1.2 DISPLAY

The keypad display indicates the status of the motor and the drive and any irregularities in the motor or drive functions. On the display, the user sees information about the drive and the present location in the menu structure and the item displayed.

Graphical display:

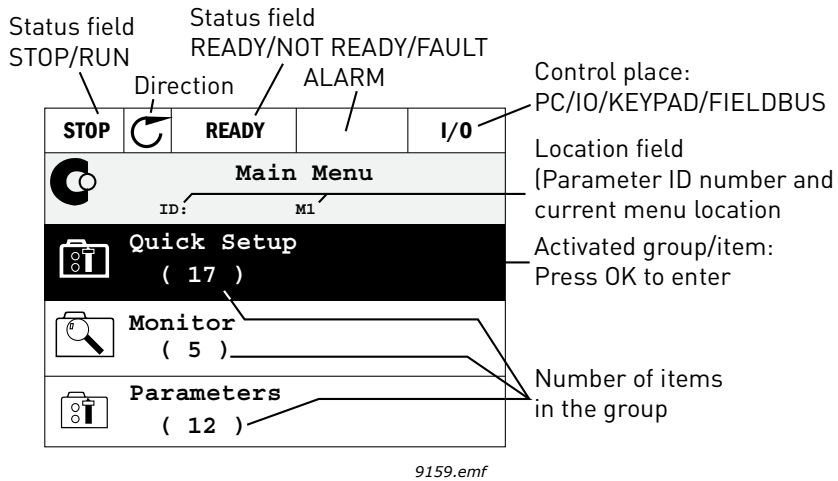

Figure 3.

If the text on the text line is too long to fit in the display, the text will scroll from left to right to show the whole text string:

Text display:

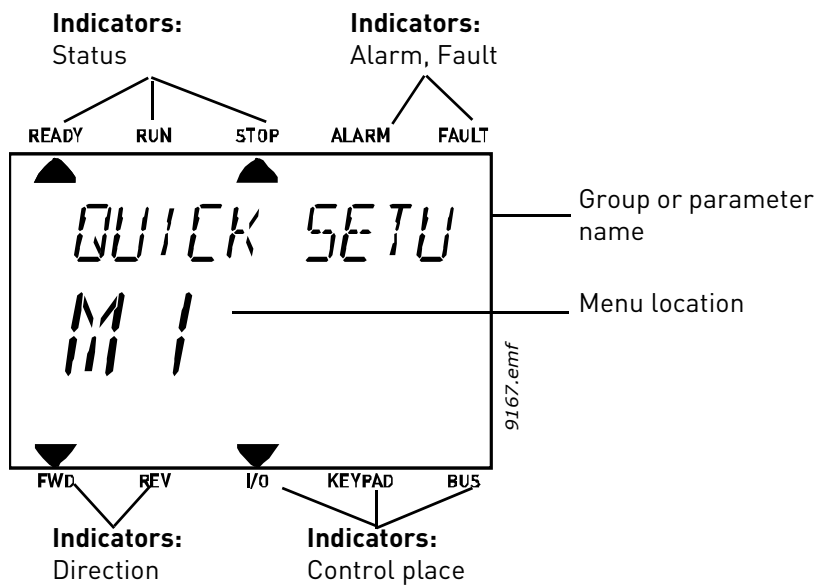

Figure 4.

1.2 FIRST STARTUP

After the drive has been powered up, Startup Wizard will be initiated.

In the Startup Wizard, you will be asked for the essential information needed by the drive to start controlling your process.

1	Language selection (P6.1)	Depends on language package
2	Daylight saving* (P5.5.5)	Russia US EU OFF
3	Time* (P5.5.2)	hh:mm:ss
4	Year* (P5.5.4)	yyyy
5	Date* (P5.5.3)	dd.mm.

* These questions appear if battery is installed

6	Run Startup Wizard?	Yes No
----------	---------------------	-----------

Select 'Yes' and push OK. If you select 'No' the drive will exit the wizard.

NOTE! If you select 'No' and push OK, you will have to set all parameter values manually.

7	Select preset application configuration (P1.2 Application (ID 212))	Standard HVAC PID Control Multipump (Single drive) Multipump (Multidrive)
----------	---	---

NOTE! If you change the value of P1.2 Application (ID 212) later on the **graphical keypad**, the wizard will guide you from **step 8** to **step 17** and jump then to the selected application wizard.

8	Select <i>P3.1.2.2</i> Motor Type (according to nameplate)	PM Motor Induction Motor
9	Set value for <i>P3.1.1.1</i> Motor Nominal Voltage (according to nameplate)	Range: Varies
10	Set value for <i>P3.1.1.2</i> Motor Nominal Frequency (according to nameplate)	Range: 8.00...320.00 Hz
11	Set value for <i>P3.1.1.3</i> Motor Nominal Speed (according to nameplate)	Range: 24...19200
12	Set value for <i>P3.1.1.4</i> Motor Nominal Current	Range: Varies
13	Set value for <i>P3.1.1.5</i> Motor Cos Phi	Range: 0.30-1.00

If '*Induction Motor*' has been selected in **step 8**, **steps 9 - 13** appear. If '*PM Motor*' has been selected, **steps 9 - 12** appear and the wizard will jump to **step 14** after them.

14	Set value for <i>P3.3.1.1</i> Minimum Frequency Reference	Range: 0.00...P3.3.1.2 Hz
15	Set value for <i>P3.3.1.2</i> Maximum Frequency Reference	Range:P3.3.1.1...320.00 Hz
16	Set value for <i>P3.4.1.2</i> Acceleration Time 1	Range: 0.1...300.0 s
17	Set value for <i>P3.4.1.3</i> Deceleration Time 1	Range: 0.1...300.0 s
18	Run Application Wizard?	Yes No

If you select '*Yes*' and push the OK button you will be taken to the application wizard according to the selection you made in **step 7**.

If you select '*No*' and push OK, the wizard will stop and you will have to set all parameter values manually.

Now the Startup Wizard is completed.

The Startup Wizard can be re-initiated by activating the parameter *P6.5.1 Restore factory defaults* OR by choosing *Activate* for parameter *B1.1.2 Startup Wizard*.

1.3 FIRE MODE WIZARD

NOTE! THE WARRANTY IS VOID, IF THE FIRE MODE FUNCTION IS ACTIVATED.

Test Mode can be used to test the Fire Mode function without voiding the warranty. Read important information about the password and warranty issues in chapter 8.13, before you proceed.

Fire Mode Wizard is intended for easy commissioning of the Fire Mode function. The Fire Mode Wizard can be initiated by choosing *Activate* for parameter 1.1.2 in the Quick setup menu.

1	Fire Mode frequency source (P3.17.2)	Several selections, see chapter 4.17.
----------	--------------------------------------	---------------------------------------

If any other source than '*Fire mode frequency*' is selected the wizard will jump directly to question 3.

2	Fire Mode frequency (P3.17.3)	8.00 Hz...MaxFreqRef (P3.3.1.2)
3	Signal activation?	Should the signal activate on opening or closing contact? 0 = Open contact 1 = Closed contact
4	Fire Mode activation on OPEN (P3.17.4)/ Fire Mode activation on CLOSE (P3.17.5)	Choose the digital input to activate Fire mode. See also chapter 8.13.
5	Fire Mode reverse (P3.17.6)	Choose the digital input to activate the reverse direction in Fire mode. DigIn Slot0.1 = Always direction FORWARD DigIn Slot0.2 = Always direction REVERSE
6	Fire Mode password (P3.17.1)	Choose password to enable the Fire Mode function. 1234 = Enable Test mode 1002 = Enable Fire Mode

1.4 APPLICATION WIZARDS

The application wizards have been designed to ease up the commissioning and parametrising of the AC drive. They will customise the settings to meet the end use requirements in terms of functionality and I/O connections. The wizards are well suited to typical field applications, and you can select the application configuration that is nearest to the intended use of the frequency converter. The application configuration can be selected in the Startup Wizard during commissioning (see chapter 1.2, step 7), or any time with parameter P1.2 Application (ID 212). (See chapter 8).

When the selection is made with parameter P1.2, the parameter default values are set to comply with the selected application. The quick setup menu shows the most essential application-specific parameters. These parameters and all other parameters can also be edited and changed in the Parameters menu (M3) any time, giving the user a free hand to make changes, regardless of the selected application configuration.

See detailed descriptions of the applications in chapter 1.5.

When one of the applications is selected with parameter P1.2 Application (ID 212), the wizard always shows the following steps first to be followed:

1	Select <i>P3.1.2.2</i> Motor Type (according to nameplate)	PM Motor Induction Motor
2	Set value for <i>P3.1.1.1</i> Motor Nominal Voltage (according to nameplate)	Range: Varies
3	Set value for <i>P3.1.1.2</i> Motor Nominal Frequency (according to nameplate)	Range: 8.00...320.00 Hz
4	Set value for <i>P3.1.1.3</i> Motor Nominal Speed (according to nameplate)	Range: 24...19200
5	Set value for <i>P3.1.1.4</i> Motor Nominal Current	Range: Varies
6	Set value for <i>P3.1.1.5</i> Motor Cos Phi	Range: 0.30-1.00

Step 6 appears only if '*Induction Motor*' has been selected in **step 1**.

7	Set value for <i>P3.3.1.1</i> Minimum Frequency Reference	Range: 0.00...P3.3.1.2 Hz
8	Set value for <i>P3.3.1.2</i> Maximum Frequency Reference	Range:P3.3.1.1...320.00 Hz
9	Set value for <i>P3.4.1.2</i> Acceleration Time 1	Range: 0.1...300.0 s
10	Set value for <i>P3.4.1.3</i> Deceleration Time 1	Range: 0.1...300.0 s

After this the wizard moves to application-specific steps, which are presented in the following chapters:

1.4.1 STANDARD AND HVAC APPLICATION WIZARDS

If you select Standard or HVAC Application with parameter P1.2 Application (ID 212), the above-mentioned **steps 1 - 10** appear (chapter 1.4).

However, if you have selected **Standard Application** or **HVAC Application** in the Startup Wizard **step 7** (see chapter 1.2), only this step will appear:

1	Select control place (from where drive start/stop commands and frequency reference is given)	I/O Terminal Fieldbus Keypad
----------	--	------------------------------------

The Standard or HVAC Application Wizard is now completed.

1.4.2 PID CONTROL APPLICATION WIZARD

If you select PID Control Application with parameter P1.2 Application (ID 212), the above-mentioned steps 1 - 10 appear (chapter 1.4).

However, if you have selected **PID Control Application** in **step 7** of the Startup Wizard, the following steps will appear next after the Startup Wizard **step 18** (see chapter 1.2):

1	Select control place (from where drive start/stop commands and frequency reference is given)	I/O Terminal Fieldbus Keypad
2	Process Unit Selection (P3.13.1.4)	Several selections

If % is selected as process unit, the wizard will directly jump to **step 6**. If any other unit than % is selected, the following steps appear:

3	Process Unit Min (P3.13.1.5)	Set the value according to the PID feedback signal range. E.g. 0...20mA corresponds to 0...10 Bar.
4	Process Unit Max (P3.13.1.6)	Same as above.
5	Process Unit Decimals (P3.13.1.7)	Range: 0...4
6	Feedback 1 Source Selection (P3.13.3.3)	See Table 61 for selections.

If one of the analogue input signals is selected in **step 6**, **step 7** appears. Otherwise the wizard will jump directly to **step 8**.

7	Analogue Input Signal Range	0 = 0...10V / 0...20mA 1 = 2...10V / 4...20mA
8	Error Inversion (P3.13.1.8)	0 = Normal 1 = Inverted
9	Setpoint Source Selection (P3.13.2.6)	See Table 60 for selections.

If one of the analogue input signals is selected in **step 9**, **step 10** appears and **step 12** after that. If any other selection than AI1 - AI6 is made, the wizard will jump to **step 11**.

If either of the options 'Keypad Setpoint 1' or 'Keypad Setpoint 2' is chosen in **step 9**, the wizard will jump directly to **step 12**.

10	Analogue Input Signal Range	0 = 0...10V / 0...20mA 1 = 2...10V / 4...20mA
11	Keypad Setpoint (P3.13.2.1 or P3.13.2.2)	Depends on selection at step 9.
12	Sleep Function?	0 = No 1 = Yes

If option 'Yes' is selected, the following steps appear. Otherwise, the wizard will jump directly to the end.

13	Sleep Frequency Limit (P3.13.5.1)	Range: 0.00...320.00 Hz
14	Sleep Delay 1 (P3.13.5.2)	Range: 0...3000 s
15	Wake-up Level (P3.13.5.3)	Range depends on selected process unit.

The PID Control Application Wizard is now completed.

1.4.3 MULTIPUMP (SINGLE DRIVE) APPLICATION WIZARD

If you select Multipump (single drive) Application with parameter P1.2 Application (ID 212), the above-mentioned steps 1 - 10 appear (chapter 1.4).

However, if you have selected **Multipump (Single drive) Application** in **step 7** of the Startup Wizard, the following steps will appear next after the Startup Wizard **step 18** (see chapter 1.2):

1	Select control place (from where drive start/stop commands and frequency reference is given)	I/O Terminal Fieldbus Keypad
2	Process Unit Selection (P3.13.1.4)	Several selections

If % is selected as process unit, the wizard will directly jump to **step 6**. If any other unit than % is selected, the following steps appear:

3	Process Unit Min (P3.13.1.5)	Set the value according to the PID feedback signal range. E.g. 0...20mA corresponds to 0...10 Bar.
4	Process Unit Max (P3.13.1.6)	Same as above.
5	Process Unit Decimals (P3.13.1.7)	Range: 0...4
6	Feedback 1 Source Selection (P3.13.3.3)	See Table 61 for selections.

If one of the analogue input signals is selected in **step 6**, **step 7** appears. Otherwise the wizard will jump directly to **step 8**.

7	Analogue Input Signal Range	0 = 0...10V / 0...20mA 1 = 2...10V / 4...20mA
8	Error Inversion (P3.13.1.8)	0 = Normal 1 = Inverted
9	Setpoint Source Selection (P3.13.2.6)	See Table 60 for selections.

If one of the analogue input signals is selected in **step 9**, **step 10** appears and **step 12** after that. If any other selection than AI1 - AI6 is made, the wizard will jump to **step 11**.

If either of the options 'Keypad Setpoint 1' or 'Keypad Setpoint 2' is chosen in **step 9**, the wizard will jump directly to **step 12**.

10	Analogue Input Signal Range	0 = 0...10V / 0...20mA 1 = 2...10V / 4...20mA
11	Keypad Setpoint (P3.13.2.2)	Depends on selection at step 9.
12	Sleep Function?	0 = No 1 = Yes

If option 'Yes' is selected, **steps 13 - 15** appear. Otherwise, the wizard will jump directly to the **step 16**.

13	Sleep Frequency Limit (P3.13.5.1)	Range: 0.00...320.00 Hz
14	Sleep Delay 1 (P3.13.5.2)	Range: 0...3000 s
15	Wake-up Level (P3.13.5.3)	Range depends on selected process unit.
16	Number of pumps (P3.15.2)	Range: 1...8
17	Pump Interlocking (P3.15.5)	0 = Not Used 1 = Enabled
18	Autochange (P3.15.6)	0 = Disabled 1 = Enabled (Interval) 2 = Enabled (Real Time)

If Autochange function is enabled, **steps 19-24** will appear. If Autochange is disabled, the wizard will jump directly to **step 25**.

19	Autochanged pumps (P3.15.7)	0 = Auxiliary pumps 1 = All pumps
-----------	-----------------------------	--------------------------------------

Step 20 appears only if option 'Enabled (Interval)' was selected in **step 18**.

20	Autochange Interval (P3.15.8)	Range: 0...3000 s
-----------	-------------------------------	-------------------

Steps 21-22 appear only if option 'Enabled (Real Time)' was selected in **step 18**.

21	Autochange Days (P3.15.9)	Range: Monday...Sunday
22	Autochange Time of Day (P3.15.10)	Range: 00:00:00...23:59:59
23	Autochange Frequency Limit (P3.15.11)	Range: P3.3.1.1...P3.3.1.2 Hz
24	Autochange Pump Limit (P3.15.12)	Range: 1...8
25	Bandwidth (P3.15.13)	0...100%
26	Bandwidth delay (P3.15.14)	0...3600 s

The Multipump (single drive) Application Wizard is now completed.

1.4.4 MULTIPUMP (MULTIDRIVE) APPLICATION WIZARD

If you select Multipump (Multidrive) Application with parameter P1.2 Application (ID 212), the above-mentioned steps 1 - 10 appear (chapter 1.4).

However, if you have selected **Multipump (Multidrive) Application** in **step 7** of Startup Wizard, the following steps will appear next after Startup Wizard **step 18** (see chapter 1.2):

1	Select the control place (from where drive start/stop commands and frequency reference is given)	I/O Terminal Fieldbus Keypad
2	Process Unit Selection (P3.13.1.4)	Several selections

If % is selected as the process unit, the wizard will directly jump to **step 6**. If any other unit than % is selected, the following steps appear:

3	Process Unit Min (P3.13.1.5)	Set the value according to the PID feedback signal range. E.g. 0...20mA corresponds to 0...10 Bar.
4	Process Unit Max (P3.13.1.6)	Same as above.
5	Process Unit Decimals (P3.13.1.7)	Range: 0...4
6	Feedback 1 Source Selection (P3.13.3.3)	See Table 61 for selections.

If one of the analogue input signals is selected in **step 6**, **step 7** appears. Otherwise the wizard will jump directly to **step 8**.

7	Analogue Input Signal Range	0 = 0...10V / 0...20mA 1 = 2...10V / 4...20mA
8	Error Inversion (P3.13.1.8)	0 = Normal 1 = Inverted
9	Setpoint Source Selection (P3.13.2.6)	See Table 60 for selections.

If one of the analogue input signals is selected in **step 9**, **step 10** appears and **step 12** after that. If any other selection than AI1 - AI6 is made, the wizard will jump to **step 11**.

If either of the options 'Keypad Setpoint 1' or 'Keypad Setpoint 2' is chosen in **step 9**, the wizard will jump directly to **step 12**.

10	Analogue Input Signal Range	0 = 0...10V / 0...20mA 1 = 2...10V / 4...20mA
11	Keypad Setpoint (P3.13.2.2)	Depends on the selection at step 9.
12	Sleep Function?	0 = No 1 = Yes

If option 'Yes' is selected, **steps 13 - 15** appear. Otherwise, the wizard will jump directly to **step 16**.

13	Sleep Frequency Limit (P3.13.5.1)	Range: 0.00...320.00 Hz
14	Sleep Delay 1 (P3.13.5.2)	Range: 0...3000 s
15	Wake-up Level (P3.13.5.3)	Range depends on the selected process unit.
16	Multipump Mode (P3.15.1)	1 = Multifollower 2 = Multimaster
17	Pump ID Number (P3.15.3)	Range: 1...8
18	Drive Operation mode (P3.15.4)	0 = Auxiliary drive 1 = Leading drive
19	Number of pumps (P3.15.2)	Range: 1...8
20	Pump Interlocking (P3.15.5)	0 = Not Used 1 = Enabled
21	Autochange (P3.15.6)	0 = Disabled 1 = Enabled (Interval) 2 = Enabled (Weekdays)

If Autochange function is enabled (interval), **step 23** will appear and after that the wizard will jump to **step 26**. If Autochange function is enabled (Weekdays), the wizard will jump to **step 24**. If Autochange is disabled, the wizard will jump directly to **step 26**.

22	Autochanged pumps (P3.15.7)	0 = Auxiliary pumps 1 = All pumps
-----------	-----------------------------	--------------------------------------

Step 23 appears only if option 'Enabled (Interval)' was selected in **step 18**.

23	Autochange Interval (P3.15.8)	Range: 0...3000 s
-----------	-------------------------------	-------------------

Steps 24-25 appear only if option 'Enabled (Weekdays)' was selected in **step 18**.

24	Autochange Days (P3.15.9)	Range: Monday...Sunday
25	Autochange Time of Day (P3.15.10)	Range: 00:00:00...23:59:59
26	Bandwidth (P3.15.13)	0...100%
27	Bandwidth delay (P3.15.14)	0...3600 s

The Multipump (Multidrive) Application Wizard is now completed.

1.5 DESCRIPTION OF THE APPLICATIONS

1.5.1 STANDARD AND HVAC APPLICATIONS

Standard and HVAC applications are typically used in simple speed-controlled applications (e.g. pumps and fans), where no special features are needed.

The drive can be controlled either from Keypad, Fieldbus or I/O terminal.

In I/O terminal control, the drive frequency reference signal is connected either to AI1 (0...10V) or AI2 (4...20mA), depending on the reference signal type. There are also three preset frequency references available. Preset references can be activated by DI4 and DI5. Drive start/stop signals are connected to DI1 (start forward) and DI2 (Start reverse).

All drive outputs are freely configurable. One analogue output (Output Frequency) and three relay outputs (Run, Fault, Ready) are available on the basic I/O board.

See the detailed descriptions on the application-specific parameters in chapter 8.

1.5.1.1 Standard and HVAC application default control connections

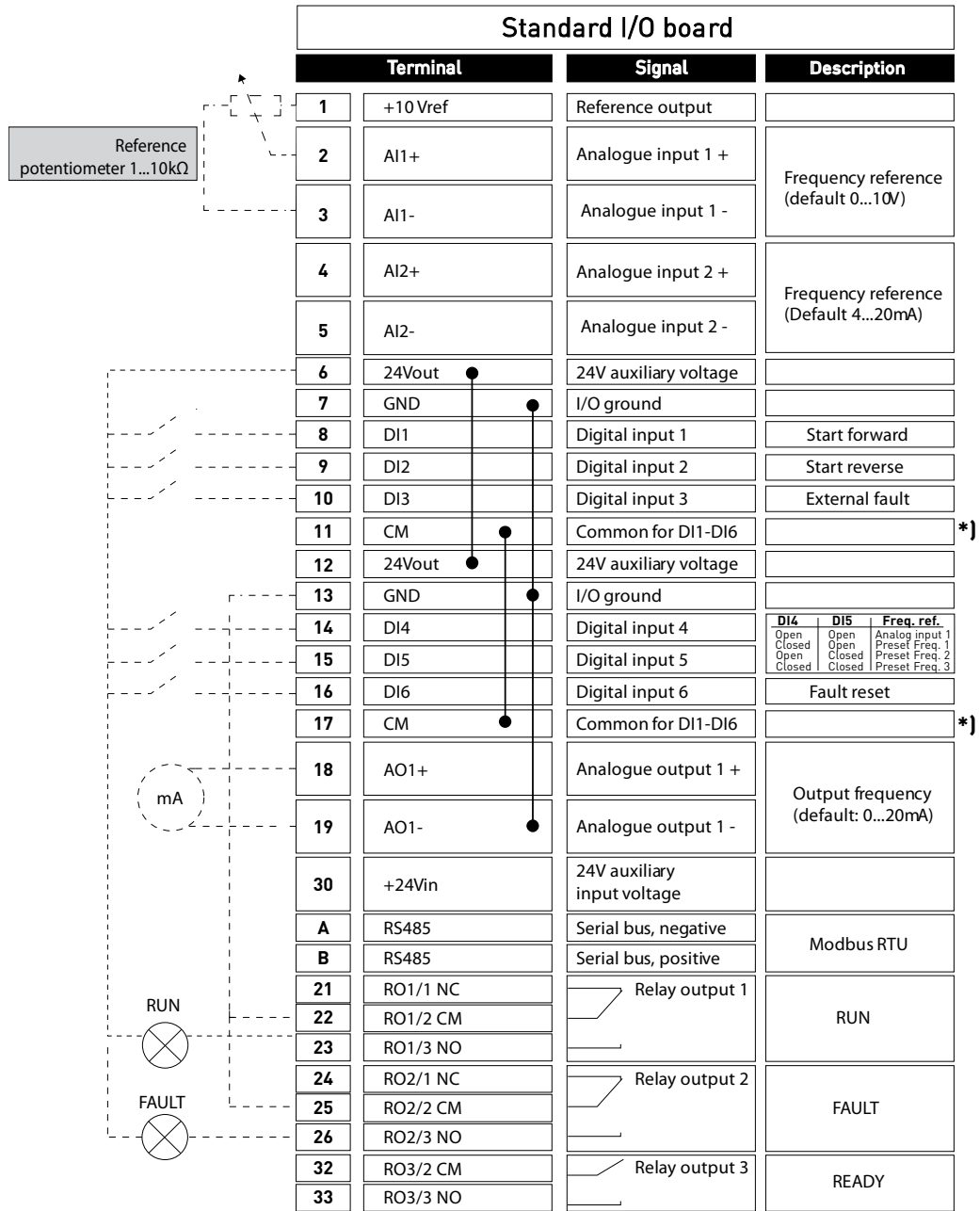

9301.emf

Figure 5.

*) Digital inputs can be isolated from the ground with a DIP switch, see the figure below:

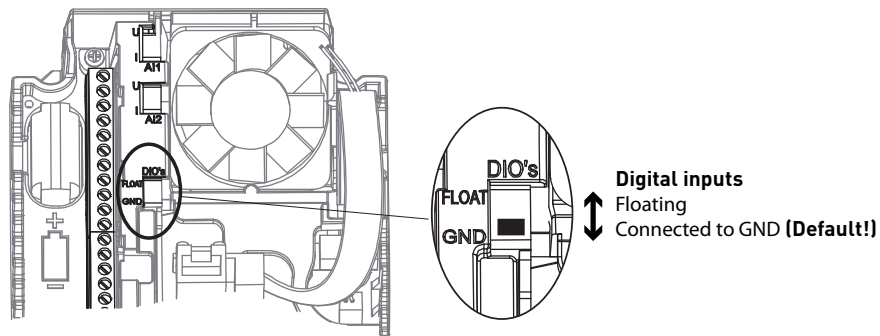

9109.emf

Figure 6.

1.5.1.2 Standard and HVAC application quick setup parameters

M1.1 Wizards

Index	Parameter	Min	Max	Unit	Default	ID	Description
1.1.1	Startup Wizard	0	1		0	1170	0 = Do not activate 1 = Activate Choosing <i>Activate</i> initiates Startup Wizard (see Chapter 1.2 "First startup").
1.1.2	Fire Mode Wizard	0	1		0	1672	Choosing <i>Activate</i> initiates Fire Mode Wizard (see chapter Chapter 1.3 "Fire mode wizard").

M1 Quick Setup:

Index	Parameter	Min	Max	Unit	Default	ID	Description
1.2	Application	0	4		1	212	0=Standard 1=HVAC 2=PID Control 3=Multipump (Single drive) 4=Multipump (Multidrive)
1.3	Minimum Frequency Reference	0.00	P1.4	Hz	0.0	101	Minimum allowed frequency reference.
1.4	Maximum Frequency Reference	P1.3	320.0	Hz	50.0/60.0	102	Maximum allowed frequency reference.
1.5	Acceleration Time 1	0.1	3000.0	s	5.0	103	Defines the time required for the output frequency to increase from zero frequency to maximum frequency.
1.6	Deceleration Time 1	0.1	3000.0	s	5.0	103	Defines the time required for the output frequency to decrease from maximum frequency to zero frequency.
1.7	Motor Current Limit	$I_H * 0.1$	I_S	A	Varies	107	Maximum motor current from AC drive.
1.8	Motor Type	0	1		0	650	0=Induction Motor 1=Permanent Magnet Motor
1.9	Motor Nominal Voltage	Varies	Varies	V	Varies	110	Find this value U_n on the rating plate of the motor. NOTE! Also used connection (Delta/Star).
1.10	Motor Nominal Frequency	8,0	320,0	Hz	50.0/60.0	111	Find this value f_n on the rating plate of the motor.
1.11	Motor Nominal Speed	24	19200	Rpm	Varies	112	Find this value n_n on the rating plate of the motor.
1.12	Motor Nominal Current	$I_H * 0.1$	I_S	A	Varies	113	Find this value I_n on the rating plate of the motor.
1.13	Motor Cos Phi	0.3	1.00		Varies	120	Find this value on the rating plate of the motor.

Index	Parameter	Min	Max	Unit	Default	ID	Description
1.14	Energy Optimisation	0	1		0	666	The drive searches for the minimum motor current in order to save energy and to lower the motor noise. This function can be used e.g. in fan and pump applications. 0=Disabled 1=Enabled
1.15	Identification	0	2		0	631	The automatic motor identification calculates or measures the motor parameters that are needed for optimum motor and speed control. 0 = No action 1 = At standstill 2 = With rotation NOTE! Motor nameplate parameters has to be set before executing the identification.
1.16	Start Function	0	1		0	505	0=Ramping 1=Flying Start
1.17	Stop Function	0	1		0	506	0=Coasting 1=Ramping
1.18	Automatic Reset	0	1		0	731	0=Disabled 1=Enabled
1.19	Response to External Fault	0	3		2	701	0=No action 1=Alarm 2=Fault (Stop according to stop mode) 3=Fault (Stop by coasting)
1.20	Response to AI Low Fault	0	5		0	700	0=No action 1=Alarm 2=Alarm+preset fault frequency (par. P3.9.1.13) 3=Alarm + previous frequency 4=Fault (Stop according to stop mode) 5=Fault (Stop by coasting)
1.21	Remote Control Place	0	1		0	172	Selection of remote control place (start/stop). 0=I/O control 1=Fieldbus control

Index	Parameter	Min	Max	Unit	Default	ID	Description
1.22	I/O Control Reference A Selection	1	20		5	117	Selection of frequency reference source when control place is I/O A 0=PC 1=Preset Frequency 0 2=Keypad Reference 3=Fieldbus 4=AI1 5=AI2 6=AI1+AI2 7=PID 8=Motor Potentiometer 11=Block 1 Out 12=Block 2 Out 13=Block 3 Out 14=Block 4 Out 15=Block 5 Out 16=Block 6 Out 17=Block 7 Out 18=Block 8 Out 19=Block 9 Out 20=Block 10 Out NOTE! Default value depends on the selected application with parameter 1.2
1.23	Keypad Control Reference Selection	1	20		1	121	See P1.22.
1.24	Fieldbus Control Reference Selection	1	20		2	122	See P1.22.
1.25	AI1 Signal Range	0	1		0	379	0= 0..10V / 0..20mA 1= 2..10V / 4..20mA
1.26	AI2 Signal Range	0	1		1	390	0= 0..10V / 0..20mA 1= 2..10V / 4..20mA
1.27	RO1 Function	0	51		2	1101	See P3.5.3.2.1.
1.28	RO2 Function	0	51		3	1104	See P3.5.3.2.1.
1.29	RO3 Function	0	51		1	1107	See P3.5.3.2.1.
1.30	A01 Function	0	31		2	10050	See P3.5.4.1.1.

M1.31 Standard / M1.32 HVAC

Index	Parameter	Min	Max	Unit	Default	ID	Description
1.31.1	Preset Frequency 1	P1.3	P1.4	Hz	10,0	105	Preset Frequency selected by digital input DI4.
1.31.2	Preset Frequency 2	P1.3	P1.4	Hz	15,0	106	Preset Frequency selected by digital input DI5.
1.31.3	Preset Frequency 3	P1.3	P1.4	Hz	20,0	126	Preset Frequency selected by digital input DI4 and DI5.

1.5.2 PID CONTROL APPLICATION

The PID control application is typically used in applications where the process variable (e.g. pressure) is controlled by controlling the speed of the motor (e.g. pump or fan). In this configuration, the drive's internal PID controller will be configured for one setpoint and one feedback signal. The PID control application provides a smooth control and an integrated measuring and controlling package, where no additional components are needed.

Two individual control places can be used. Selection between control places A and B is done by DI6. When control place A is active, start/stop commands are given by DI1 and frequency reference is taken from PID controller. When control place B is active, start/stop commands are given by DI4 and frequency reference is taken directly from AI1.

All drive outputs are freely configurable. One analogue output (Output Frequency) and three relay outputs (Run, Fault, Ready) are available on the basic I/O board.

See detailed descriptions on the application-specific parameters in chapter 8.

1.5.2.1 PID control application default control connections

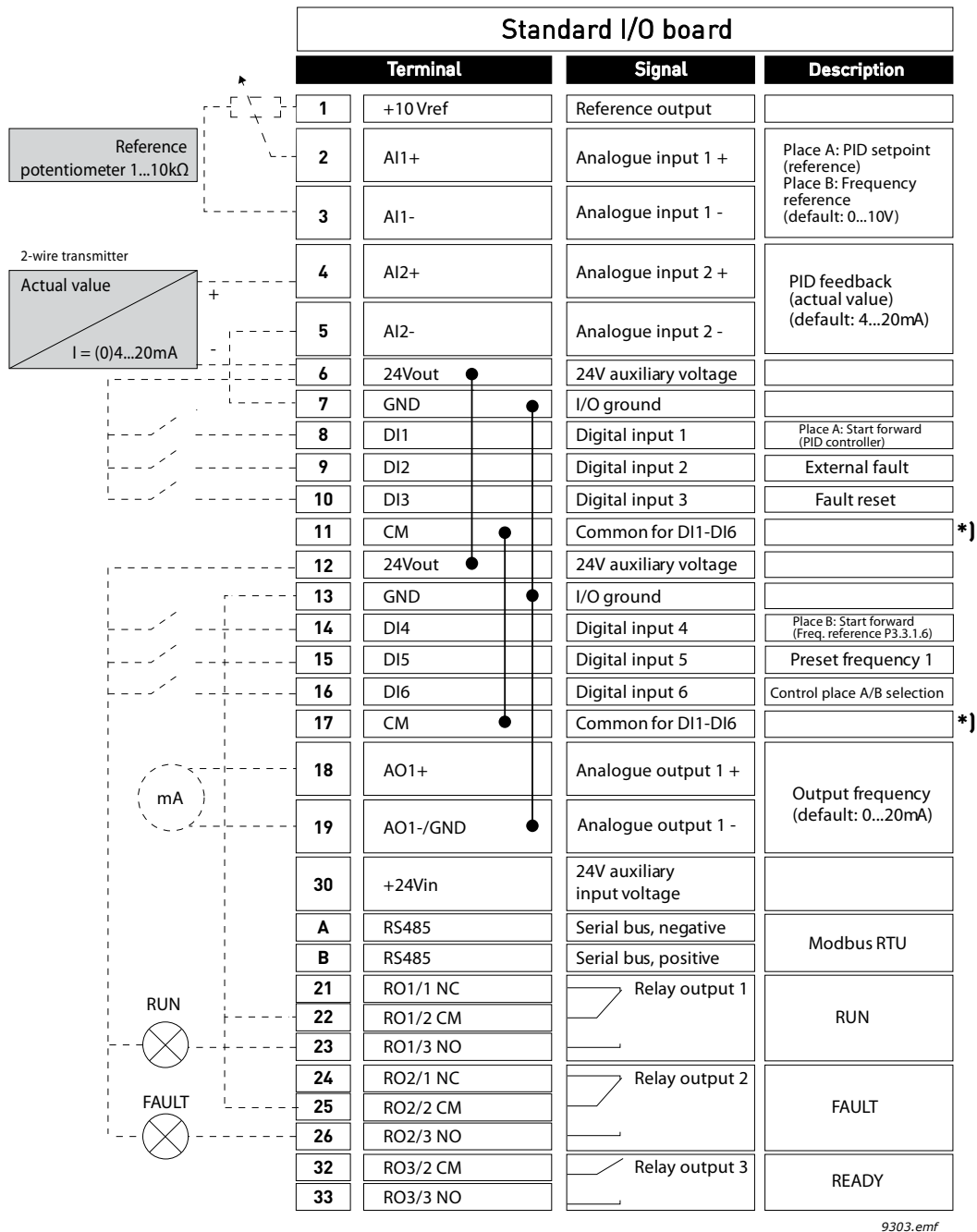

9303.emf

Figure 7.

*) Digital inputs can be isolated from the ground with a DIP switch, see figure below

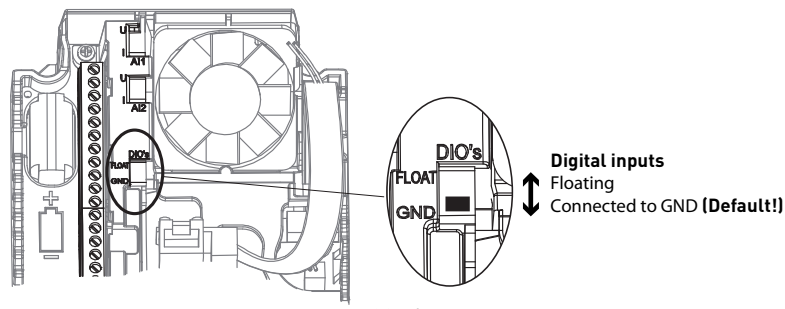

Figure 8.

1.5.2.2 PID control application quick setup parameters

M1.1 Wizards

Index	Parameter	Min	Max	Unit	Default	ID	Description
1.1.1	Startup Wizard	0	1		0	1170	0 = Do not activate 1 = Activate Choosing <i>Activate</i> initiates the Startup Wizard (see Chapter 1.2 "First startup").
1.1.2	Fire Mode Wizard	0	1		0	1672	Choosing <i>Activate</i> initiates the Fire Mode Wizard (see Chapter 1.3 "Fire mode wizard").

M1 Quick Setup:

Index	Parameter	Min	Max	Unit	Default	ID	Description
1.2	Application	0	4		2	212	0=Standard 1=HVAC 2=PID Control 3=Multipump (Single drive) 4=Multipump (Multidrive)
1.3	Minimum Frequency Reference	0.00	P1.4	Hz	0.0	101	Minimum allowed frequency reference.
1.4	Maximum Frequency Reference	P1.3	320.0	Hz	50.0/60.0	102	Maximum allowed frequency reference.
1.5	Acceleration Time 1	0.1	3000.0	s	5.0	103	Defines the time required for the output frequency to increase from zero frequency to maximum frequency.
1.6	Deceleration Time 1	0.1	3000.0	s	5.0	104	Defines the time required for the output frequency to decrease from maximum frequency to zero frequency.
1.7	Motor Current Limit	$I_H \cdot 0.1$	I_S	A	Varies	107	Maximum motor current from AC drive.
1.8	Motor Type	0	1		0	650	0=Induction Motor 1=Permanent Magnet Motor
1.9	Motor Nominal Voltage	Varies	Varies	V	Varies	110	Find this value U_n on the rating plate of the motor. NOTE! also used connection (Delta/Star).
1.10	Motor Nominal Frequency	8,0	320,0	Hz	50.0	111	Find this value f_n on the rating plate of the motor.
1.11	Motor Nominal Speed	24	19200	Rpm	Varies	112	Find this value n_n on the rating plate of the motor.
1.12	Motor Nominal Current	$I_H \cdot 0.1$	I_S	A	Varies	113	Find this value I_n on the rating plate of the motor.
1.13	Motor Cos Phi	0,30	1.00		Varies	120	Find this value on the rating plate of the motor.

Index	Parameter	Min	Max	Unit	Default	ID	Description
1.14	Energy Optimisation	0	1		0	666	The drive searches for the minimum motor current in order to save energy and to lower the motor noise. This function can be used e.g. in fan and pump applications. 0=Disabled 1=Enabled
1.15	Identification	0	2		0	631	The automatic motor identification calculates or measures the motor parameters that are needed for optimum motor and speed control. 0 = No action 1 = At standstill 2 = With rotation NOTE! Motor nameplate parameters has to be set before executing the identification.
1.16	Start Function	0	1		0	505	0=Ramping 1=Flying Start
1.17	Stop Function	0	1		0	506	0=Coasting 1=Ramping
1.18	Automatic Reset	0	1		0	731	0=Disabled 1=Enabled
1.19	Response to External Fault	0	3		2	701	0=No action 1=Alarm 2=Fault (Stop according to stop mode) 3=Fault (Stop by coasting)
1.20	Response to AI Low Fault	0	5		0	700	0=No action 1=Alarm 2=Alarm+preset fault frequency (par. P3.9.1.13) 3=Alarm + previous frequency 4=Fault (Stop according to stop mode) 5=Fault (Stop by coasting)
1.21	Remote Control Place	0	1		0	172	Selection of remote control place (start/stop). 0=I/O control 1=Fieldbus control

Index	Parameter	Min	Max	Unit	Default	ID	Description
1.22	I/O Control Reference A Selection	1	20		6	117	Selection of frequency reference source when control place is I/O A 0=PC 1=Preset Frequency 0 2=Keypad Reference 3=Fieldbus 4=AI1 5=AI2 6=AI1+AI2 7=PID 8=Motor Potentiometer 11=Block 1 Out 12=Block 2 Out 13=Block 3 Out 14=Block 4 Out 15=Block 5 Out 16=Block 6 Out 17=Block 7 Out 18=Block 8 Out 19=Block 9 Out 20=Block 10 Out NOTE! Default value depends on the selected application with parameter 1.2.
1.23	Keypad Control Reference Selection	1	20		1	121	See P1.22.
1.24	Fieldbus Control Reference Selection	1	20		2	122	See P1.22.
1.25	AI1 Signal Range	0	1		0	379	0= 0..10V / 0..20mA 1= 2..10V / 4..20mA
1.26	AI2 Signal Range	0	1		1	390	0= 0..10V / 0..20mA 1= 2..10V / 4..20mA
1.27	R01 Function	0	51		2	11001	See P3.5.3.2.1.
1.28	R02 Function	0	51		3	11004	See P3.5.3.2.1.
1.29	R03 Function	0	51		1	11007	See P3.5.3.2.1.
1.30	A01 Function	0	31		2	10050	See P3.5.4.1.1.

M1.33 PID Control

Index	Parameter	Min	Max	Unit	Default	ID	Description
1.33.1	PID Gain	0.00	100.00	%	100.00	18	If the value of the parameter is set to 100% a change of 10% in the error value causes the controller output to change by 10%.
1.33.2	PID Integration Time	0.00	600.00	s	1.00	119	If this parameter is set to 1,00s a change of 10% in the error value causes the controller output to change by 10.00%/s.
1.33.3	PID Derivation Time	0.00	100.00	s	0.00	1132	If this parameter is set to 1,00s a change of 10% in the error value during 1.00 s causes the controller output to change by 10.00%.

Index	Parameter	Min	Max	Unit	Default	ID	Description
1.33.4	Feedback 1 Source selection	0	30		2	334	See P3.13.3.3.
1.33.5	Setpoint 1 Source Selection	0	32		1	332	See P3.13.2.6.
1.33.6	Keypad Setpoint 1	Varies	Varies	Varies	0	167	
1.33.7	Sleep Frequency Limit 1	0.0	320.0	Hz	0.0	1016	Drive goes to sleep mode when the output frequency stays below this limit for a time greater than that defined by parameter Sleep delay.
1.33.8	Sleep Delay 1	0	3000	s	0	1017	The minimum amount of time the frequency has to remain below the Sleep level before the drive is stopped.
1.33.9	Wake-up Level 1	Varies	Varies	Varies	Varies	1018	Defines the level for the PID feedback value wake-up supervision. Uses selected process units.
1.33.10	Preset Frequency 1	P1.3	P1.4	Hz	10,0	105	Preset Frequency selected by digital input DI5.

1.5.3 MULTIPUMP (SINGLE DRIVE) APPLICATION

Multipump (Single Drive) application is designed for applications where one drive is controlling a system consisting of up to 8 parallel motors (e.g. pumps, fans, compressors). By default, Multipump (Single Drive) application is configured for 3 parallel motors.

The drive is connected to one of the motors. The internal PID controller of the drive controls the speed of the regulating motor and gives control signals (via relay outputs) to start/stop the auxiliary motors. External contactors are needed to switch the auxiliary motors to supply mains.

The process variable (e.g. pressure) is controlled by controlling the speed of the one motor and the number of running motors.

See the detailed descriptions on the application-specific parameters in chapter 8.11.

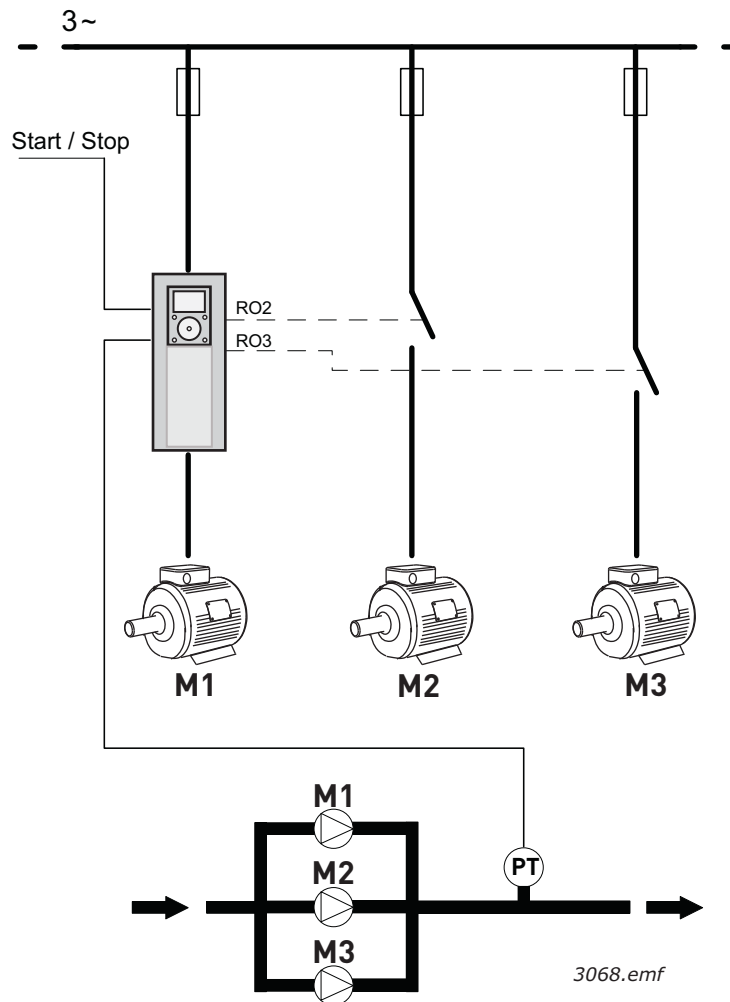

Figure 9. Principle of Multipump (Single Drive) configuration (PT = Pressure sensor)

Autochange -function can be used for equalising the wear of all motors in the system. Autochange function monitors the running hours of each motor and arranges the starting order of the motors according to them. Motor with the lowest running hours is started first and motor with the greatest running hours is started last. Autochange (change of starting order) can be configured to take place based on autochange interval time or based on drives internal real time clock (if RTC-battery is installed into the drive).

Autochange can be configured to cover all the pumps in the system or only the auxiliary pumps.

NOTE! Different connections, depending on selected autochange mode (See Figure 10 and Figure 11).

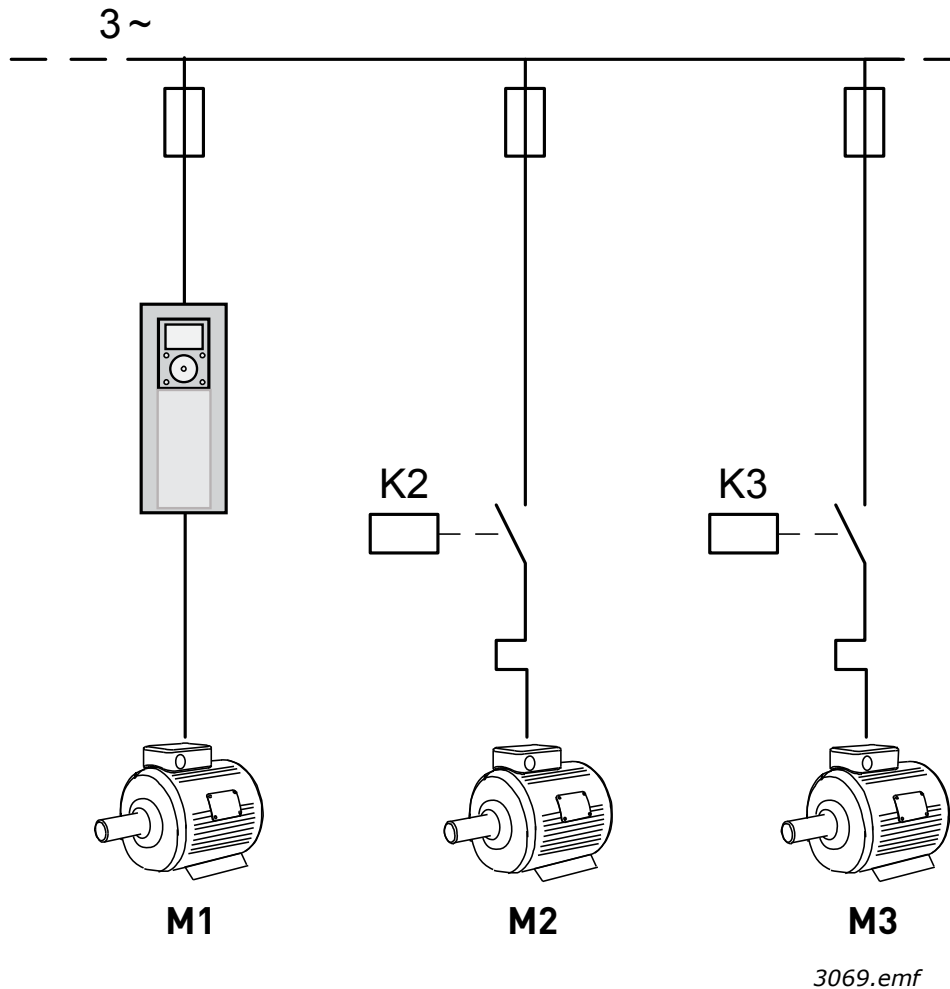

Figure 10. Principal control diagram, when only auxiliary motors are autochanged.

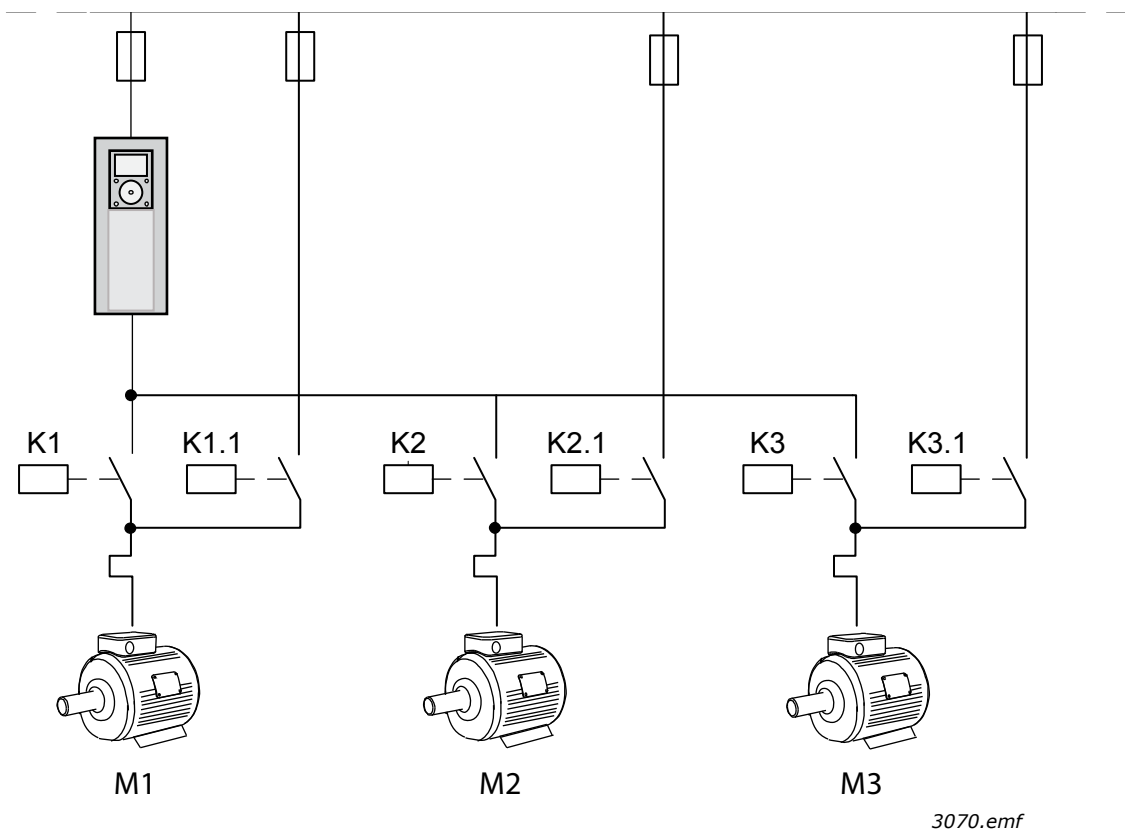
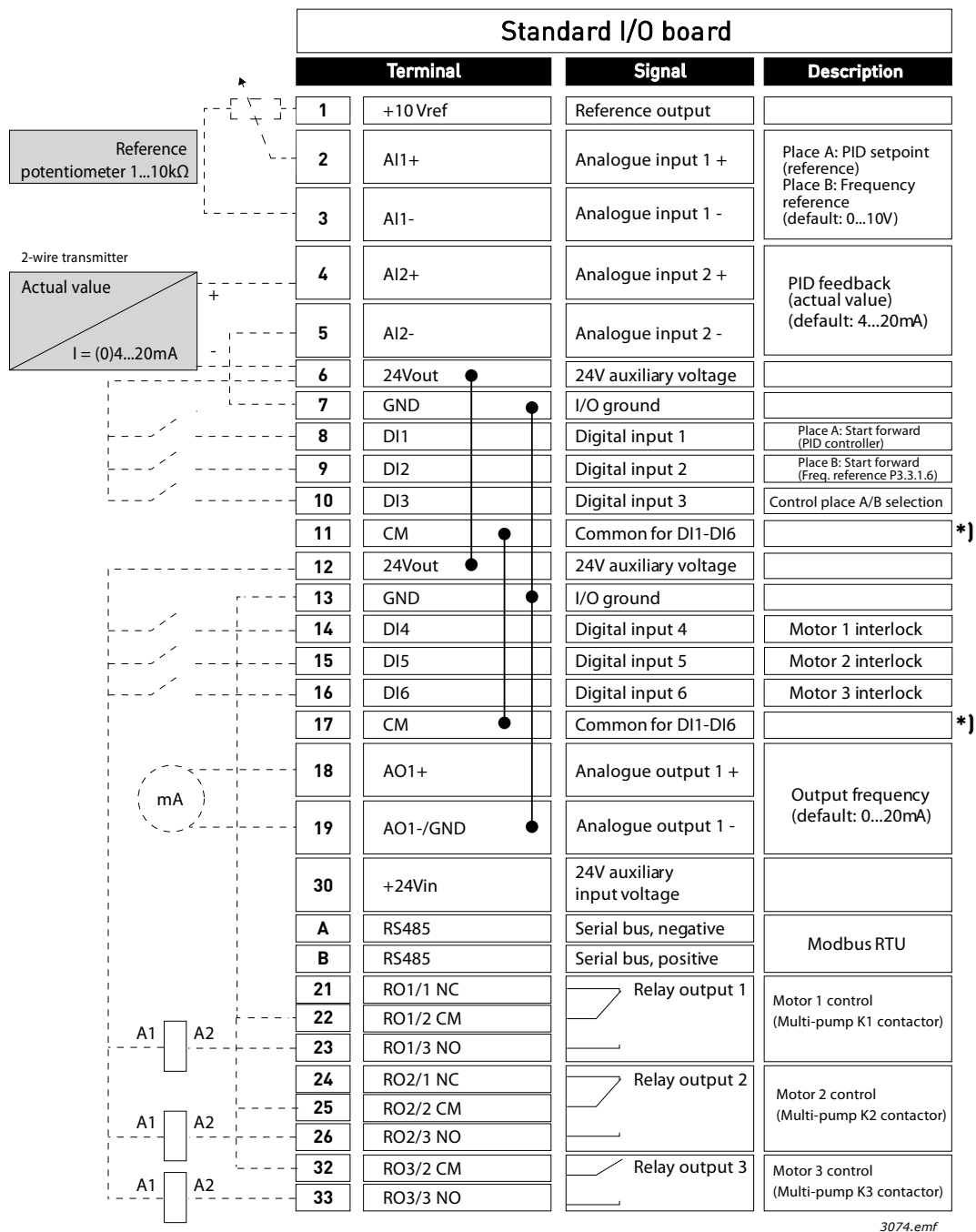

Figure 11. Principal control diagram, when all pumps are autochanged

Two individual control places can be used. Selection between control places A and B is done with DI6. When control place A is active, start/stop commands are given with DI1 and frequency reference is taken from PID controller. When control place B is active, start/stop commands are given with DI4 and frequency reference is taken directly from AI1.

All drive outputs are freely configurable. One analogue output (Output Frequency) and three relay outputs (Run, Fault, Ready) are available on the basic I/O board.

1.5.3.1 Multipump (single drive) application default control connections



3074.emf

Figure 12.

*) Digital inputs can be isolated from the ground with a DIP switch, see figure below

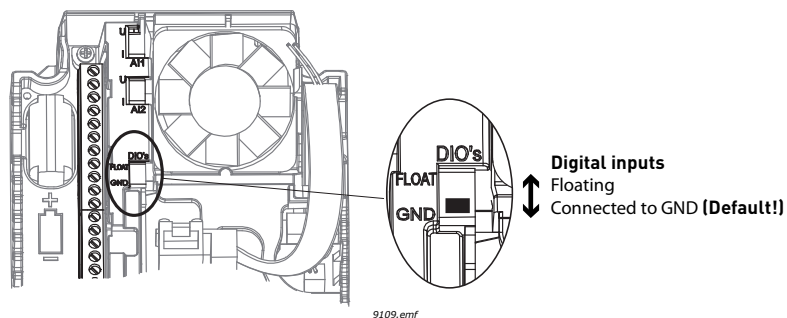

9109.emf

Figure 13.

1.5.3.2 Multipump (single drive) application quick setup parameters

M1.1 Wizards

Index	Parameter	Min	Max	Unit	Default	ID	Description
1.1.1	Startup Wizard	0	1		0	1170	0 = Do not activate 1 = Activate Choosing <i>Activate</i> initiates Startup Wizard (see Chapter 1.2 "First startup").
1.1.2	Fire Mode Wizard	0	1		0	1672	Choosing <i>Activate</i> initiates Fire Mode Wizard (see Chapter 1.3 "Fire mode wizard").

M1 Quick Setup:

Index	Parameter	Min	Max	Unit	Default	ID	Description
1.2	Application	0	4		3	212	0=Standard 1=HVAC 2=PID Control 3=Multipump (Single drive) 4=Multipump (Multidrive)
1.3	Minimum Frequency Reference	0.00	P1.4	Hz	0.0	101	Minimum allowed frequency reference.
1.4	Maximum Frequency Reference	P1.3	320.0	Hz	50.0/60.0	102	Maximum allowed frequency reference.
1.5	Acceleration Time 1	0.1	3000.0	s	5.0	103	Defines the time required for the output frequency to increase from zero frequency to maximum frequency.
1.6	Deceleration Time 1	0.1	3000.0	s	5.0	104	Defines the time required for the output frequency to decrease from maximum frequency to zero frequency.
1.7	Motor Current Limit	$I_H \cdot 0.1$	I_S	A	Varies	107	Maximum motor current from AC drive.
1.8	Motor Type	0	1		0	650	0=Induction Motor 1=Permanent Magnet Motor
1.9	Motor Nominal Voltage	Varies	Varies	V	Varies	110	Find this value U_n on the rating plate of the motor. NOTE! Also used connection (Delta/Star).
1.10	Motor Nominal Frequency	8,0	320,0	Hz	50.0	111	Find this value f_n on the rating plate of the motor.
1.11	Motor Nominal Speed	24	19200	Rpm	Varies	112	Find this value n_n on the rating plate of the motor.
1.12	Motor Nominal Current	$I_H \cdot 0.1$	I_S	A	Varies	113	Find this value I_n on the rating plate of the motor.
1.13	Motor Cos Phi	0,30	1.00		Varies	120	Find this value on the rating plate of the motor.

Index	Parameter	Min	Max	Unit	Default	ID	Description
1.14	Energy Optimisation	0	1		0	666	The drive searches for the minimum motor current in order to save energy and to lower the motor noise. This function can be used e.g. in fan and pump applications. 0=Disabled 1=Enabled
1.15	Identification	0	2		0	631	The automatic motor identification calculates or measures the motor parameters that are needed for optimum motor and speed control. 0 = No action 1 = At standstill 2 = With rotation NOTE! Motor nameplate parameters has to be set before executing the identification.
1.16	Start Function	0	1		0	505	0=Ramping 1=Flying Start
1.17	Stop Function	0	1		0	506	0=Coasting 1=Ramping
1.18	Automatic Reset	0	1		0	731	0=Disabled 1=Enabled
1.19	Response to External Fault	0	3		2	701	0=No action 1=Alarm 2=Fault (Stop according to stop mode) 3=Fault (Stop by coasting)
1.20	Response to AI Low Fault	0	5		0	700	0=No action 1=Alarm 2=Alarm+preset fault frequency (par. P3.9.1.13) 3=Alarm + previous frequency 4=Fault (Stop according to stop mode) 5=Fault (Stop by coasting)
1.21	Remote Control Place	0	1		0	172	Selection of remote control place (start/stop). 0=I/O control 1=Fieldbus control

Index	Parameter	Min	Max	Unit	Default	ID	Description
1.22	I/O Control Reference A Selection	1	20		6	117	Selection of frequency reference source when control place is I/O A 0=PC 1=Preset Frequency 0 2=Keypad Reference 3=Fieldbus 4=AI1 5=AI2 6=AI1+AI2 7=PID 8=Motor Potentiometer 11=Block 1 Out 12=Block 2 Out 13=Block 3 Out 14=Block 4 Out 15=Block 5 Out 16=Block 6 Out 17=Block 7 Out 18=Block 8 Out 19=Block 9 Out 20=Block 10 Out NOTE! Default value depends on the selected application with parameter 1.2.
1.23	Keypad Control Reference Selection	1	20		1	121	See P1.22.
1.24	Fieldbus Control Reference Selection	1	20		2	122	See P1.22.
1.25	AI1 Signal Range	0	1		0	379	0= 0..10V / 0..20mA 1= 2..10V / 4..20mA
1.26	AI2 Signal Range	0	1		1	390	0= 0..10V / 0..20mA 1= 2..10V / 4..20mA
1.27	R01 Function	0	51		2	11001	See P3.5.3.2.1.
1.28	R02 Function	0	51		3	11004	See P3.5.3.2.1.
1.29	R03 Function	0	51		1	11007	See P3.5.3.2.1.
1.30	A01 Function	0	31		2	10050	See P3.5.4.1.1.

M1.34 Multipump (single drive)

Index	Parameter	Min	Max	Unit	Default	ID	Description
1.34.1	PID Gain	0.00	100.00	%	100.00	18	If the value of the parameter is set to 100% a change of 10% in the error value causes the controller output to change by 10%.
1.34.2	PID Integration Time	0.00	600.00	s	1.00	119	If this parameter is set to 1,00s a change of 10% in the error value causes the controller output to change by 10.00%/s.
1.34.3	PID Derivation Time	0.00	100.00	s	0.00	1132	If this parameter is set to 1,00s a change of 10% in the error value during 1.00 s causes the controller output to change by 10.00%.

Index	Parameter	Min	Max	Unit	Default	ID	Description
1.34.4	Feedback 1 Source selection	0	30		2	334	See P3.13.3.3.
1.34.5	Setpoint 1 Source Selection	0	32		1	332	See P3.13.2.6.
1.34.6	Keypad Setpoint 1	Varies	Varies	Varies	0	167	
1.34.7	Sleep Frequency Limit 1	0.0	320.0	Hz	0.0	1016	Drive goes to sleep mode when the output frequency stays below this limit for a time greater than that defined by parameter Sleep delay.
1.34.8	Sleep Delay 1	0	3000	s	0	1017	The minimum amount of time the frequency has to remain below the Sleep level before the drive is stopped.
1.34.9	Wake-up Level 1	Varies	Varies	Varies	Varies	1018	Defines the level for the PID feedback value wake-up supervision. Uses selected process units.
1.34.10	Multipump mode	0	2		0	1785	Selects the Multipump mode. 0= Single drive 1= Multifollower 2=Multimaster
1.34.11	Number of pumps	1	8		1	1001	Total number of motors (pumps/fans) used in multi-pump system.
1.34.12	Pump interlocking	0	1		1	1032	Enable/Disable use of interlocks. Interlocks are used to tell the system if a motor is connected or not. 0 = Disabled 1 = Enabled
1.34.13	Autochange	0	2		1	1027	Disable/enable rotation of starting order and priority of motors. 0= Disabled 1= Enabled (interval) 2= Enabled (weekdays)
1.34.14	Autochanged pump	0	1		1	1028	0 = Auxiliary Pump 1 = All Pumps
1.34.15	Autochange interval	0.0	3000.0	h	48.0	1029	After the expiry of the time defined with this parameter, the autochange function takes place if the capacity used lies below the level defined with parameters P3.15.11 and P3.15.12

Index	Parameter	Min	Max	Unit	Default	ID	Description
1.34.16	Autochange days	0	127			15904	Range B0 = Sunday B1 = Monday B2 = Tuesday B3 = Wednesday B4 = Thursday B5 = Friday B6 = Saturday
1.34.17	Autochange time of day	00:00:00	23:59:59	Time		15905	Range: 00:00:00...23:59:59
1.34.18	Autochange: Frequency limit	0.00	P3.3.1.2	Hz	25.00	1031	These parameters define the level below which the capacity used must remain so that the autochange can take place.
1.34.19	Autochange: Pump limit	1	6		1	1030	
1.34.20	Bandwidth	0	100	%	10	1097	Percentage of the setpoint. E.g.: Setpoint = 5 bar, Bandwidth = 10%: As long as the feedback value stays within 4.5...5.5 bar motor disconnection or removal will not take place.
1.34.21	Bandwidth delay	0	3600	s	10	1098	With feedback outside the bandwidth, this time must pass before pumps are added or removed.
1.34.22	Pump 1 interlock				DigIN Slot0.1	426	FALSE = Not active TRUE = Active
1.34.23	Pump 2 interlock				DigIN Slot0.1	427	FALSE = Not active TRUE = Active
1.34.24	Pump 3 interlock				DigIN Slot0.1	428	FALSE = Not active TRUE = Active
1.34.25	Pump 4 interlock				DigIN Slot0.1	429	FALSE = Not active TRUE = Active
1.34.26	Pump 5 interlock				DigIN Slot0.1	430	FALSE = Not active TRUE = Active
1.34.27	Pump 6 interlock				DigIN Slot0.1	486	FALSE = Not active TRUE = Active
1.34.28	Pump 7 interlock				DigIN Slot0.1	487	FALSE = Not active TRUE = Active
1.34.29	Pump 8 interlock				DigIN Slot0.1	488	FALSE = Not active TRUE = Active

1.5.4 MULTIPUMP (MULTIDRIVE) APPLICATION

Multipump (Multidrive) application is designed for a system consisting of up to 8 parallel variable speed motors (e.g. pumps, fans, compressors). By default, Multipump (Multidrive) application is configured for 3 parallel motors.

See detailed descriptions on the application-specific parameters in chapter 8.11.

The checklist for commissioning a multipump (multidrive) system is presented in chapter 8.11.1.

Each motor is controlled by its own drive. Drives of the system are communicating with each other by Modbus RTU communication.

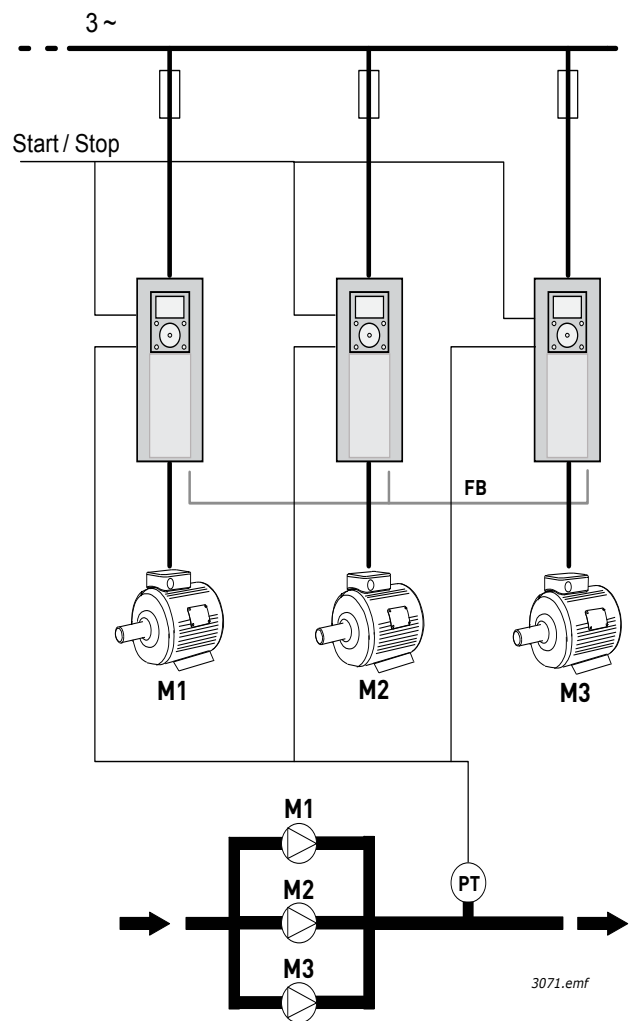

Figure 14. Principle of Multipump (Multidrive) configuration. (PT = Pressure sensor, FB = communication bus)

The process variable (e.g. pressure) is controlled by controlling the speed of the motors and the number of running motors. The internal PID controller of the leading drive controls the speed of the motors and requests the other motors to start/stop when needed.

The operation of the system depends on the selected operation mode. In Multifollower mode, auxiliary motors follow the speed of the regulating drive.

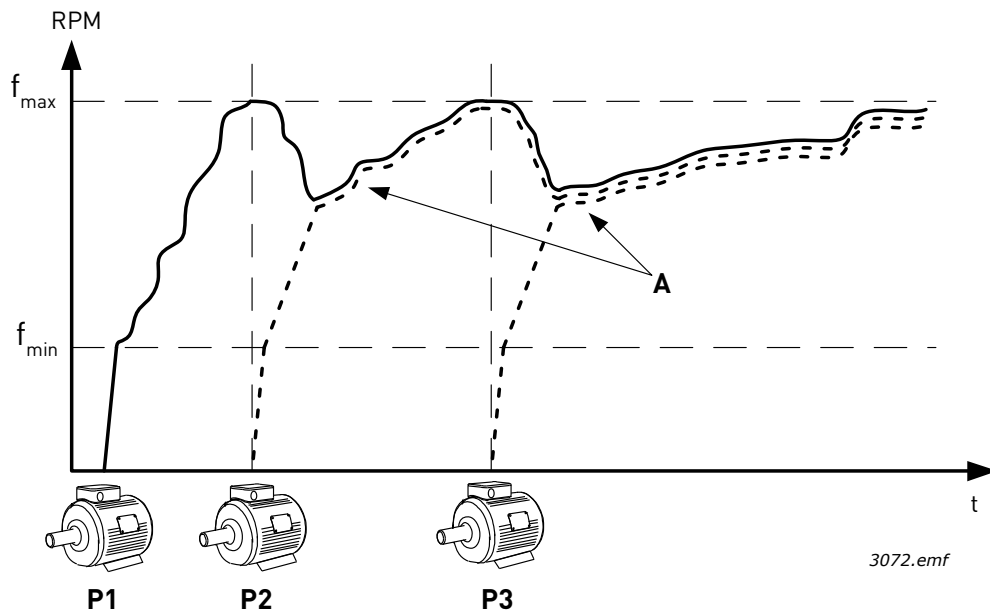

Figure 15. Regulation in Multifollower mode. Pump 1 is regulating and pumps 2 and 3 are following the speed of pump 1, as shown with curves A.

The figure below shows an example of Multimaster mode, where the speed of the regulating motor is locked to constant production speed (B), when next motor is started. (A = regulating curves of the pumps)

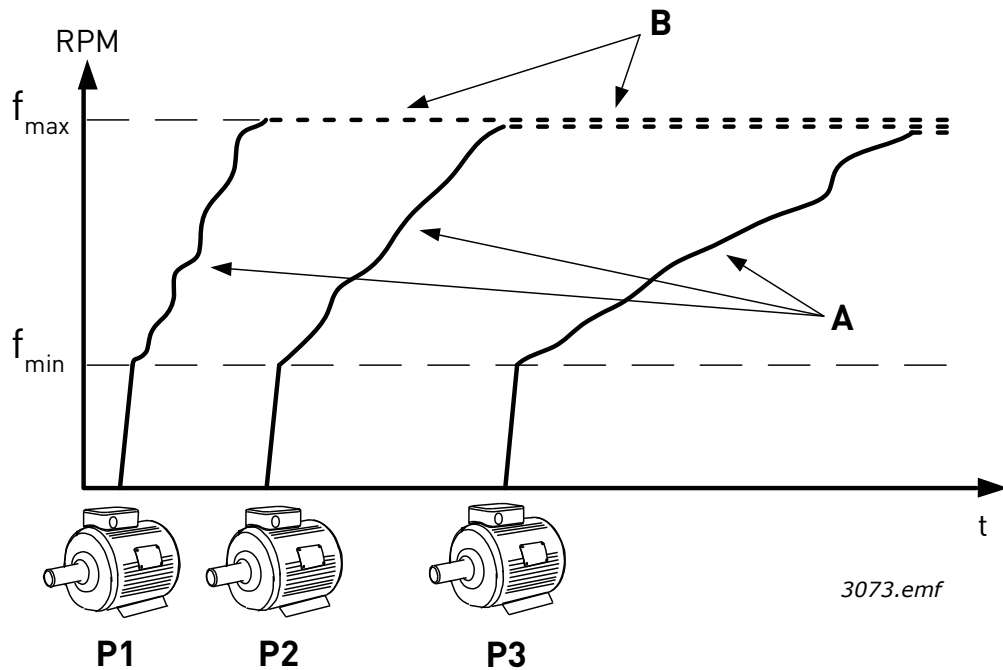

Figure 16. Regulation in Multimaster mode.

Autochange function can be used for equalising the wear of all motors in the system. Autochange function monitors the running hours of each motor and arranges the starting order of the motors according to them. Motor with the lowest running hours is started first and motor with the greatest running hours is started last. Autochange (change of starting order) can be configured to take place based on autochange interval time or based on drives internal real time clock (if RTC-battery is installed into the drive).

1.5.4.1 Multipump (multidrive) application default control connections

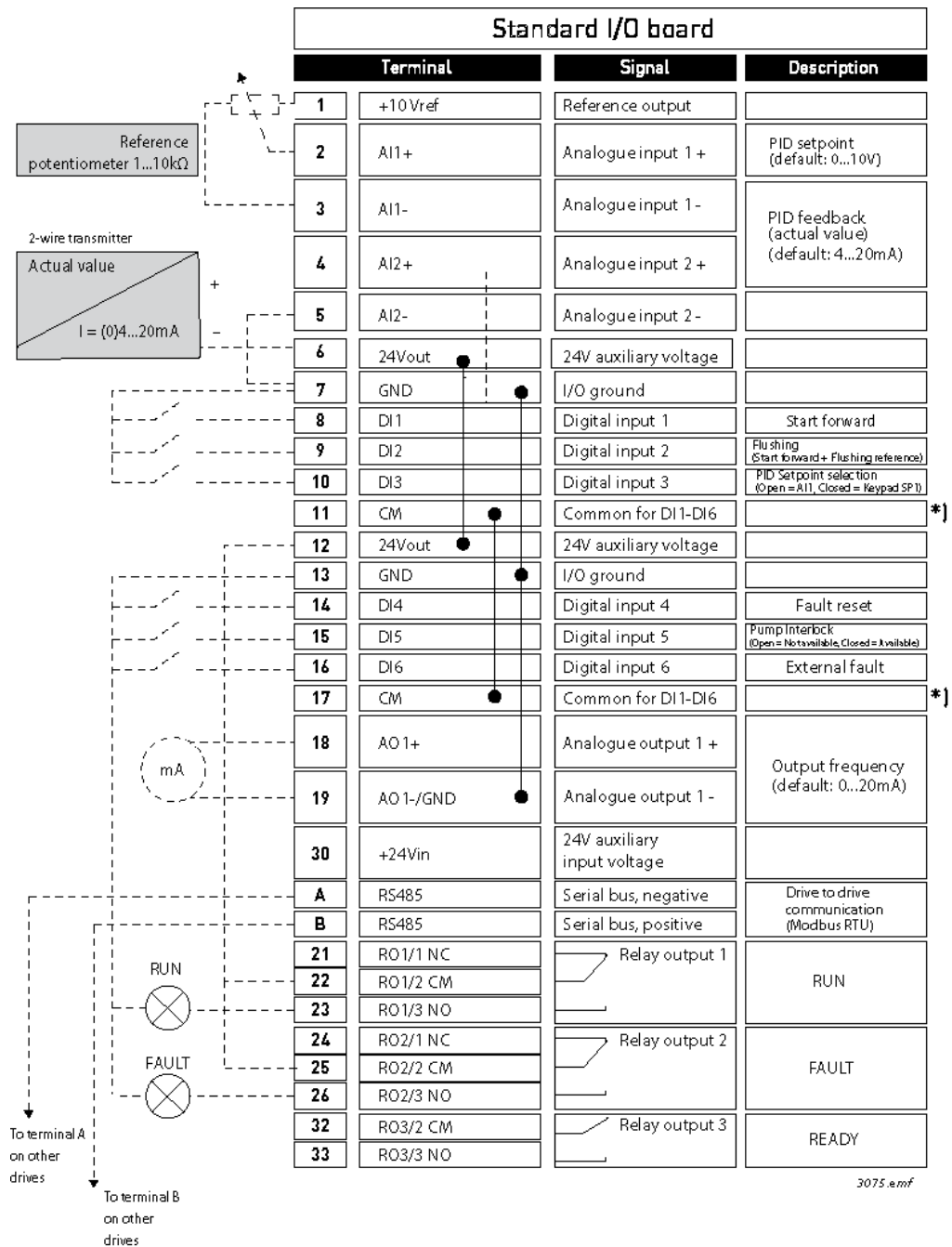

Figure 17.

CAUTION! *) Isolate the Digital inputs from the ground with the DIP switch. See the Figure 18 below.

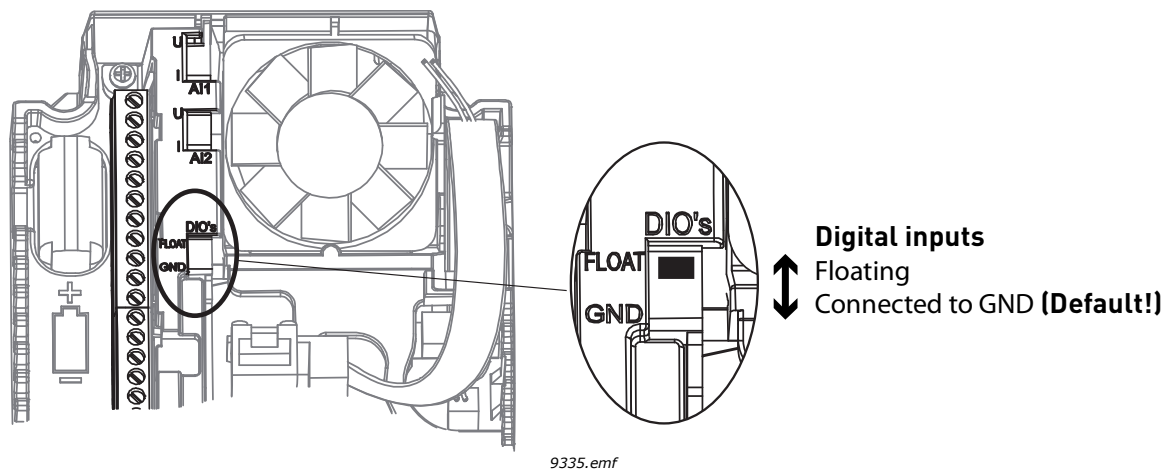
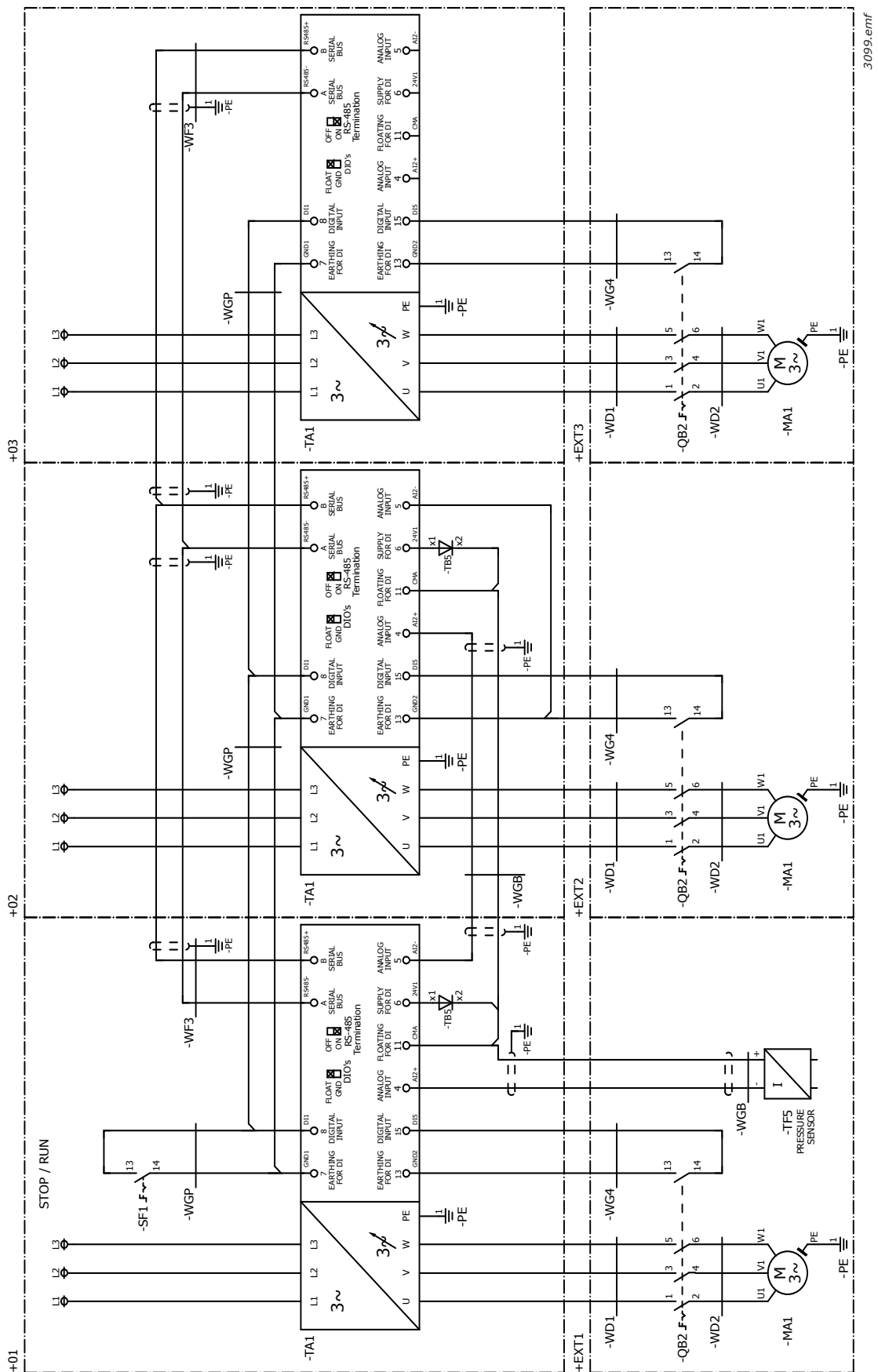

Figure 18.

1.5.4.2 Multipump (multidrive) system electric wiring diagramme



3099.cmf

Figure 19.

1.5.4.3 Multipump (multidrive) application quick setup parameters

M1.1 Wizards

Index	Parameter	Min	Max	Unit	Default	ID	Description
1.1.1	Startup Wizard	0	1		0	1170	0 = Do not activate 1 = Activate Choosing <i>Activate</i> initiates Startup Wizard (see Chapter 1.2 "First startup").
1.1.2	Fire Mode Wizard	0	1		0	1672	Choosing <i>Activate</i> initiates Fire Mode Wizard (see Chapter 1.3 "Fire mode wizard").

M1 Quick Setup:

Index	Parameter	Min	Max	Unit	Default	ID	Description
1.2	Application	0	4		4	212	0=Standard 1=HVAC 2=PID Control 3=Multipump (Single drive) 4=Multipump (Multidrive)
1.3	Minimum Frequency Reference	0.00	P1.4	Hz	0.0	101	Minimum allowed frequency reference.
1.4	Maximum Frequency Reference	P1.3	320.0	Hz	50.0/60.0	102	Maximum allowed frequency reference.
1.5	Acceleration Time 1	0.1	3000.0	s	5.0	103	Defines the time required for the output frequency to increase from zero frequency to maximum frequency.
1.6	Deceleration Time 1	0.1	3000.0	s	5.0	104	Defines the time required for the output frequency to decrease from maximum frequency to zero frequency.
1.7	Motor Current Limit	$I_H \cdot 0.1$	I_S	A	Varies	107	Maximum motor current from AC drive.
1.8	Motor Type	0	1		0	650	0=Induction Motor 1=Permanent Magnet Motor
1.9	Motor Nominal Voltage	Varies	Varies	V	Varies	110	Find this value U_n on the rating plate of the motor. NOTE! Also used connection (Delta/Star).
1.10	Motor Nominal Frequency	8,0	320,0	Hz	50.0/60.0	111	Find this value f_n on the rating plate of the motor.
1.11	Motor Nominal Speed	24	19200	Rpm	Varies	112	Find this value n_n on the rating plate of the motor.
1.12	Motor Nominal Current	$I_H \cdot 0.1$	I_S	A	Varies	113	Find this value I_n on the rating plate of the motor.
1.13	Motor Cos Phi	0,30	1.00		Varies	120	Find this value on the rating plate of the motor.

Index	Parameter	Min	Max	Unit	Default	ID	Description
1.14	Energy Optimisation	0	1		0	666	The drive searches for the minimum motor current in order to save energy and to lower the motor noise. This function can be used e.g. in fan and pump applications. 0=Disabled 1=Enabled
1.15	Identification	0	2		0	631	The automatic motor identification calculates or measures the motor parameters that are needed for optimum motor and speed control. 0 = No action 1 = At standstill 2 = With rotation NOTE! Motor nameplate parameters have to be set before executing the identification.
1.16	Start Function	0	1		0	505	0=Ramping 1=Flying Start
1.17	Stop Function	0	1		0	506	0=Coasting 1=Ramping
1.18	Automatic Reset	0	1		0	731	0=Disabled 1=Enabled
1.19	Response to External Fault	0	3		2	701	0=No action 1=Alarm 2=Fault (Stop according to stop mode) 3=Fault (Stop by coasting)
1.20	Response to AI Low Fault	0	5		0	700	0=No action 1=Alarm 2=Alarm+preset fault frequency (par. P3.9.1.13) 3=Alarm + previous frequency 4=Fault (Stop according to stop mode) 5=Fault (Stop by coasting)
1.21	Remote Control Place	0	1		0	172	Selection of remote control place (start/stop). 0=I/O control 1=Fieldbus control

Index	Parameter	Min	Max	Unit	Default	ID	Description
1.22	I/O Control Reference A Selection	1	20		6	117	Selection of frequency reference source when control place is I/O A. 0=PC 1=Preset Frequency 0 2=Keypad Reference 3=Fieldbus 4=AI1 5=AI2 6=AI1+AI2 7=PID 8=Motor Potentiometer 11=Block 1 Out 12=Block 2 Out 13=Block 3 Out 14=Block 4 Out 15=Block 5 Out 16=Block 6 Out 17=Block 7 Out 18=Block 8 Out 19=Block 9 Out 20=Block 10 Out NOTE! Default value depends on the selected application with parameter 1.2.
1.23	Keypad Control Reference Selection	1	20		1	121	See P1.22.
1.24	Fieldbus Control Reference Selection	1	20		2	122	See P1.22.
1.25	AI1 Signal Range	0	1		0	379	0= 0..10V / 0..20mA 1= 2..10V / 4..20mA
1.26	AI2 Signal Range	0	1		1	390	0= 0..10V / 0..20mA 1= 2..10V / 4..20mA
1.27	R01 Function	0	51		2	11001	See P3.5.3.2.1.
1.28	R02 Function	0	51		3	11004	See P3.5.3.2.1.
1.29	R03 Function	0	51		1	11007	See P3.5.3.2.1.
1.30	A01 Function	0	31		2	10050	See P3.5.4.1.1.

M1.35 Multipump (Multidrive)

Index	Parameter	Min	Max	Unit	Default	ID	Description
1.35.1	PID Gain	0.00	100.00	%	100.00	18	If the value of the parameter is set to 100%, a change of 10% in the error value causes the controller output to change by 10%.
1.35.2	PID Integration Time	0.00	600.00	s	1.00	119	If this parameter is set to 1,00s, a change of 10% in the error value causes the controller output to change by 10.00%/s.
1.35.3	PID Derivation Time	0.00	100.00	s	0.00	1132	If this parameter is set to 1,00s, a change of 10% in the error value during 1.00 s causes the controller output to change by 10.00%.

Index	Parameter	Min	Max	Unit	Default	ID	Description
1.35.4	Feedback 1 Source selection	0	30		2	334	See P3.13.3.3.
1.35.5	Setpoint 1 Source Selection	0	32		1	332	See P3.13.2.6.
1.35.6	Keypad Setpoint 1	Varies	Varies	Varies	0	167	
1.35.7	Sleep Frequency Limit 1	0.0	320.0	Hz	0.0	1016	Drive goes to sleep mode when the output frequency stays below this limit for a time greater than that defined by parameter Sleep delay.
1.35.8	Sleep Delay 1	0	3000	s	0	1017	The minimum amount of time the frequency has to remain below the Sleep level before the drive is stopped.
1.35.9	Wake-up Level 1	Varies	Varies	Varies	Varies	1018	Defines the level for the PID feedback value wake-up supervision. Uses selected process units.
1.35.10	Multipump mode	0	2		0	1785	Selects the Multipump mode. 0= Single drive 1= Multifollower 2=Multimaster
1.35.11	Number of pumps	1	6		1	1001	Total number of motors (pumps/fans) used in multi-pump system.
1.35.12	Pump ID number	1	8		1	1500	Drive order number in the pump system. NOTE! This parameter is only used in Multifollower or Multimaster modes
1.35.13	Drive operation mode	0	1		0	1782	Defines drive operation mode in Multipump (Multidrive) system. 0 = Auxiliary drive 1 = Leading drive
1.35.14	Pump interlocking	0	1		1	1032	Enable/Disable use of interlocks. Interlocks are used to tell the system if a motor is connected or not. 0 = Disabled 1 = Enabled
1.35.15	Autochange	0	1		1	1027	Disable/enable rotation of starting order and priority of motors. 0 = Disabled 1 = Enabled
1.35.16	Autochanged pump	0	1		1	1028	0 = Auxiliary Pump 1 = All Pumps



Index	Parameter	Min	Max	Unit	Default	ID	Description
1.35.17	Autochange interval	0.0	3000.0	h	48.0	1029	After the expiry of the time defined with this parameter, the autochange function takes place if the capacity used lies below the level defined with parameters P3.15.11 and P3.15.12.
1.35.18	Autochange days	0	127			1786	Range: Monday...Sunday
1.35.19	Autochange time of day			Time		1787	Range: 00:00:00...23:59:59
1.35.20	Autochange: Frequency limit	0.00	P3.3.1.2	Hz	25.00	1031	These parameters define the level below which the capacity used must remain so that the autochange can take place.
1.35.21	Autochange: Pump limit	1	6		1	1030	
1.35.22	Bandwidth	0	100	%	10	1097	Percentage of the setpoint. E.g.: Setpoint = 5 bar, Bandwidth = 10%: As long as the feedback value stays within 4.5...5.5 bar motor disconnection or removal will not take place.
1.35.23	Bandwidth delay	0	3600	s	10	1098	With feedback outside the bandwidth, this time must pass before pumps are added or removed.
1.35.24	Constant production speed	0	100	%	100	1513	Defines the constant speed at which the pump is locked after the maximum frequency is reached and the next pump starts to regulate in Multimaster Mode
1.35.25	Pump 1 interlock				DigIN Slot0.1	426	FALSE = Not active TRUE = Active
1.35.26	Flushing reference	-Max ref.	Max. ref.	Hz	50.00	1239	Defines the frequency reference when flushing function is activated.

2. USER INTERFACES ON VACON®100 FLOW

This chapter presents the different user interfaces on Vacon® 100 FLOW:

- Keypad
- Vacon Live
- Fieldbus

2.1 NAVIGATION ON KEYPAD

See the keypad button and display description in chapter 1.1.

The data on the control keypad are arranged in menus and submenus. Use the Up and Down arrows to move between the menus. Enter the group/item by pressing the OK button and return to the former level by pressing the Back/Reset button.

The *Location field* indicates your current location. The *Status field* gives information about the present status of the drive. See Figure 21.

The basic menu structure is depicted in Figure 20.

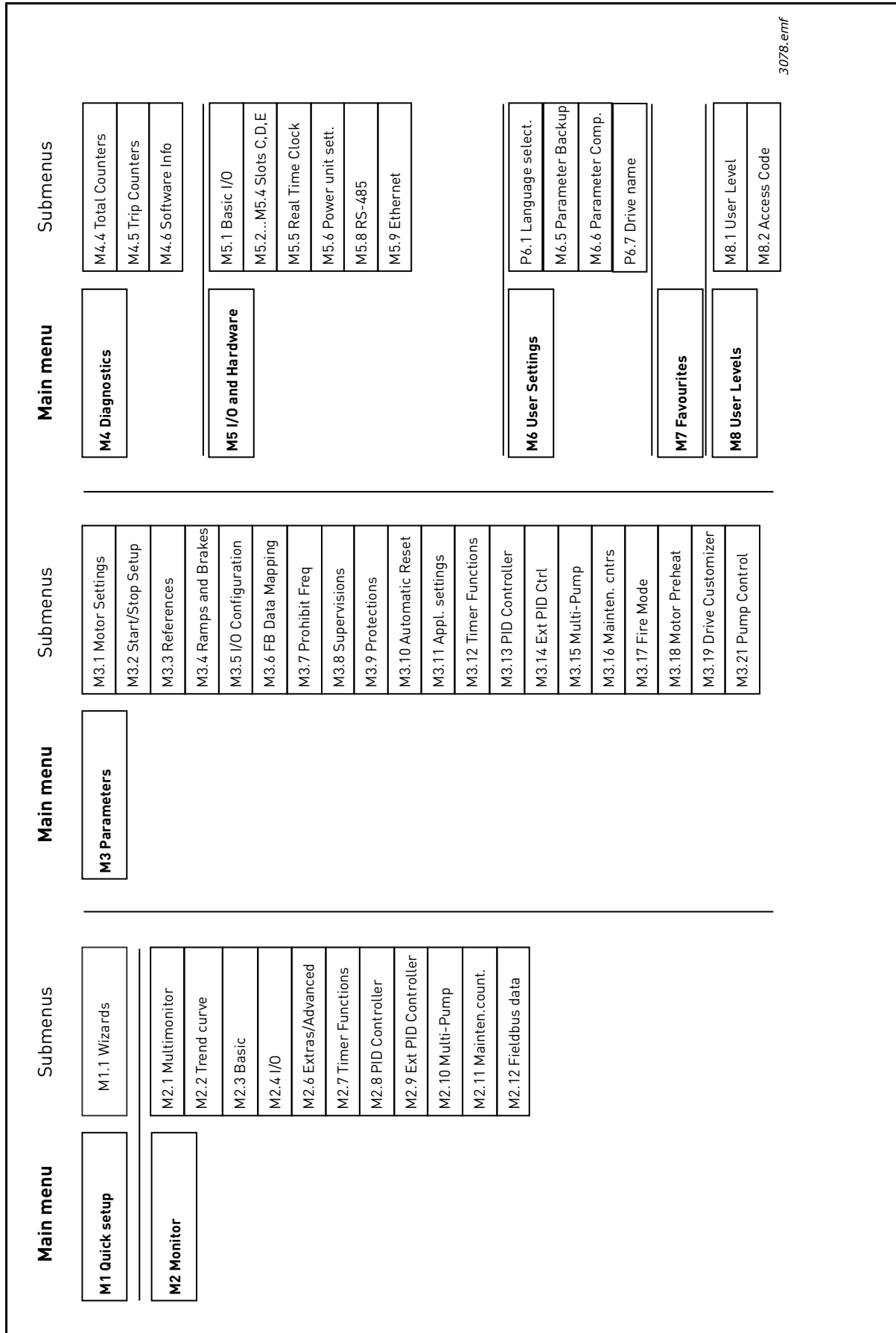

3078.emf

Figure 20. Keypad navigation chart

2.2 VACON GRAPHICAL KEYPAD

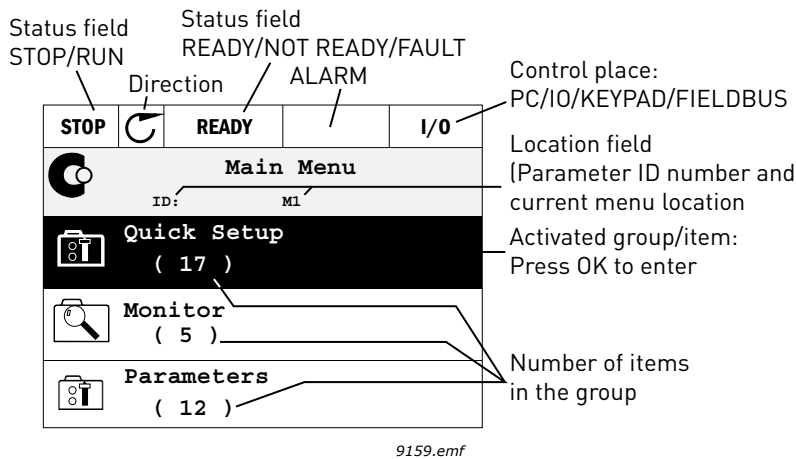

Figure 21. Main menu

2.2.1 USING THE GRAPHICAL KEYPAD

2.2.1.1 Editing values

The selectable values can be accessed and edited in two different ways on the graphical keypad.

Parameters with one valid value

Typically, for one parameter is set one value. The value is selected either from a list of values (see the example below) or the parameter is given a numerical value from a defined range (e.g. 0.00...50.00 Hz).

Change the value of a parameter by following the procedure below:

1. Locate the parameter.
2. Enter the *Edit* mode.
3. Set the new value with the arrow buttons Up/Down. You can also move from digit to digit with the arrow buttons Left/Right, if the value is numerical and then change the value with the arrow buttons Up/Down.
4. Confirm the change with OK button or ignore the change by returning to the previous level with Back/Reset button.

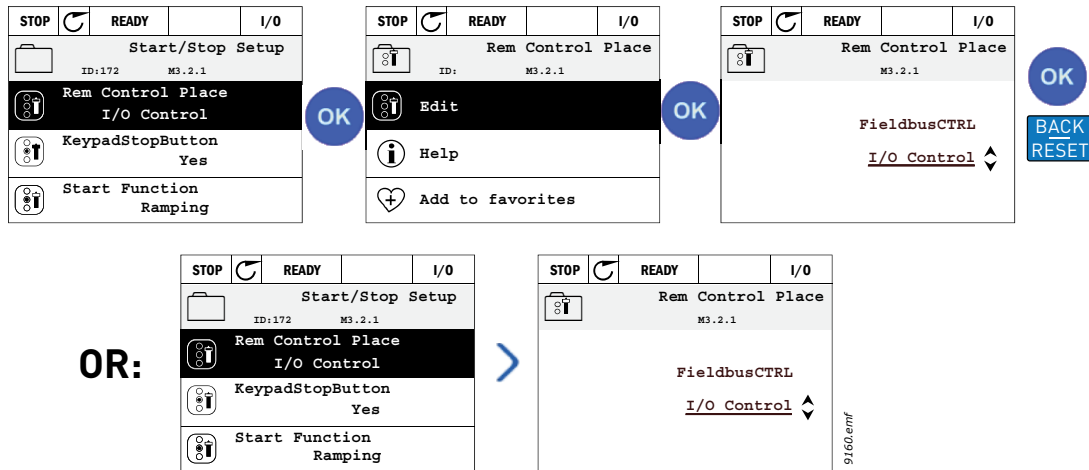

Figure 22. Typical editing of values on graphical keypad (text value)

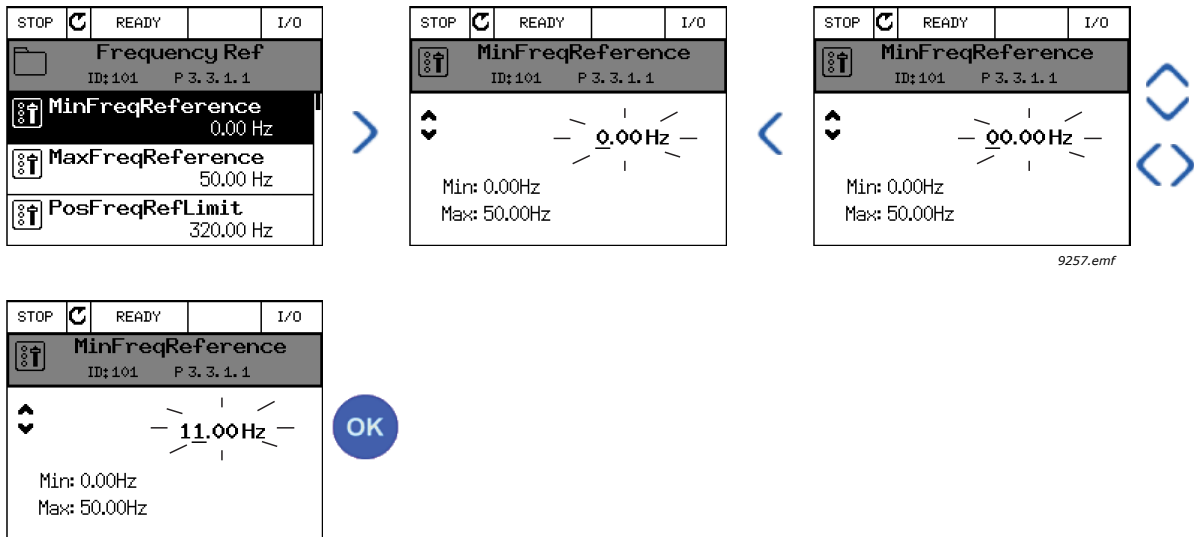

Figure 23. Typical editing of values on graphical keypad (numerical value)

Parameters with checkbox selection

Some parameters allow selecting several values. Make a checkbox selection at each value you wish to activate as instructed below.

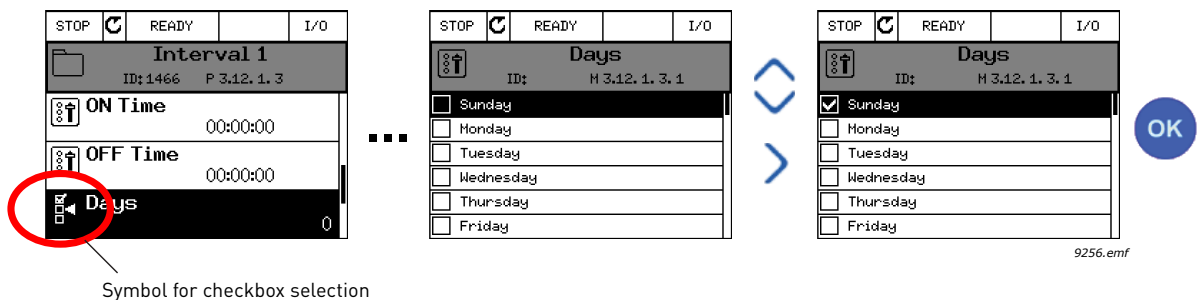

Figure 24. Applying the checkbox value selection on graphical keypad

2.2.1.2 Resetting fault

Instructions on how to reset a fault can be found in chapter 9.1 Fault appears.

2.2.1.3 Function button

The FUNCT button is used for four functions:

1. to quickly access the Control page,
2. to easily change between the Local (Keypad) and Remote control places,
3. to change the rotation direction and
4. to quickly edit a parameter value.

Control places

The *control place* is the source of control, where the drive can be started and stopped. Every control place has its own parameter for selecting the frequency reference source. The *Local control place* is always the keypad. The *Remote control place* is determined by parameter P3.2.1 (I/O or Fieldbus). The selected control place can be seen on the status bar of the keypad.

Remote control place

I/O A, I/O B and Fieldbus can be used as remote control places. I/O A and Fieldbus have the lowest priority and can be chosen with parameter P3.2.1 (*Rem Control Place*). I/O B, again, can bypass the remote control place selected with parameter P3.2.1 using a digital input. The digital input is selected with parameter P3.5.1.7 (*I/O B Ctrl Force*).

Local control

Keypad is always used as the control place while in local control. Local control has higher priority than remote control. Therefore, if, for example, bypassed by parameter P3.5.1.7 through digital input while in *Remote*, the control place will still switch to Keypad if *Local* is selected. Switching between Local and Remote Control is made by pressing the FUNCT button on the keypad or by using the "Local/Remote" (ID211) parameter.

Changing control places

Change of control place from *Remote* to *Local* (keypad).

1. Anywhere in the menu structure, push the FUNCT button.
2. Push the *Arrow up* or the *Arrow down* button to select *Local/Remote* and confirm with the OK button.
3. On the next display, select *Local* or *Remote* and again confirm with the OK button.
4. The display will return to the same location as it was when the FUNCT button was pushed. However, if the Remote control place was changed to Local (Keypad), you will be instructed to keypad reference.

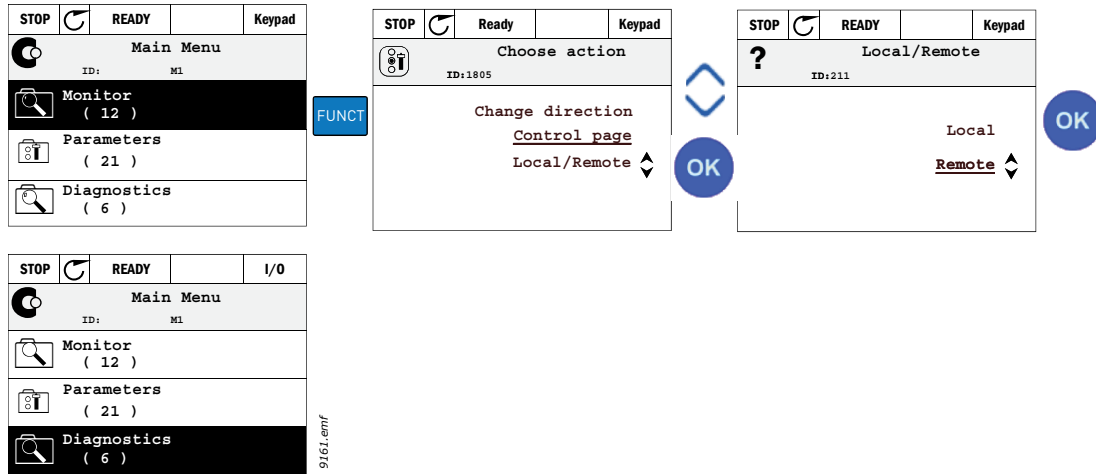

Figure 25. Changing control places

Accessing the control page

The *Control page* is meant for easy operation and monitoring of the most essential values.

1. Anywhere in the menu structure, push the FUNCT button.
2. Push the *Arrow up* or the *Arrow down* button to select *Control page* and confirm with the OK button.
3. The control page appears

If the keypad control place and the keypad reference are selected to be used, you can set the *Keypad reference* after having pressed the OK button. If other control places or reference values are used, the display will show Frequency reference, which is not editable. The other values on the page are Multimonitoring values. You can choose which values appear here for monitoring (for this procedure, see 2.4.2 Monitor).

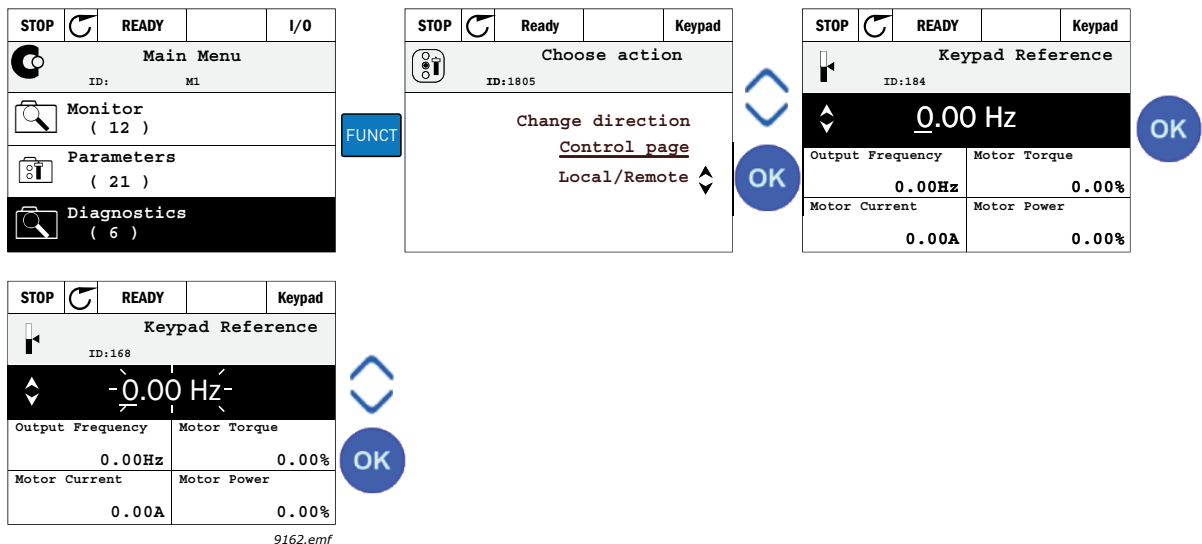

Figure 26. Accessing Control page

Changing direction

Rotation direction of the motor can quickly be changed by applying the FUNCT button.

NOTE! *Changing direction* command is not visible in the menu unless the selected control place is *Local*.

1. Anywhere in the menu structure, push the FUNCT button.
2. Push the *Arrow up* or the *Arrow down* button to select Change direction and confirm with the OK button.
3. Then choose the direction you wish to run the motor to. The actual rotation direction is blinking. Confirm with the OK button.
4. The rotation direction changes immediately and the arrow indication in the status field changes.

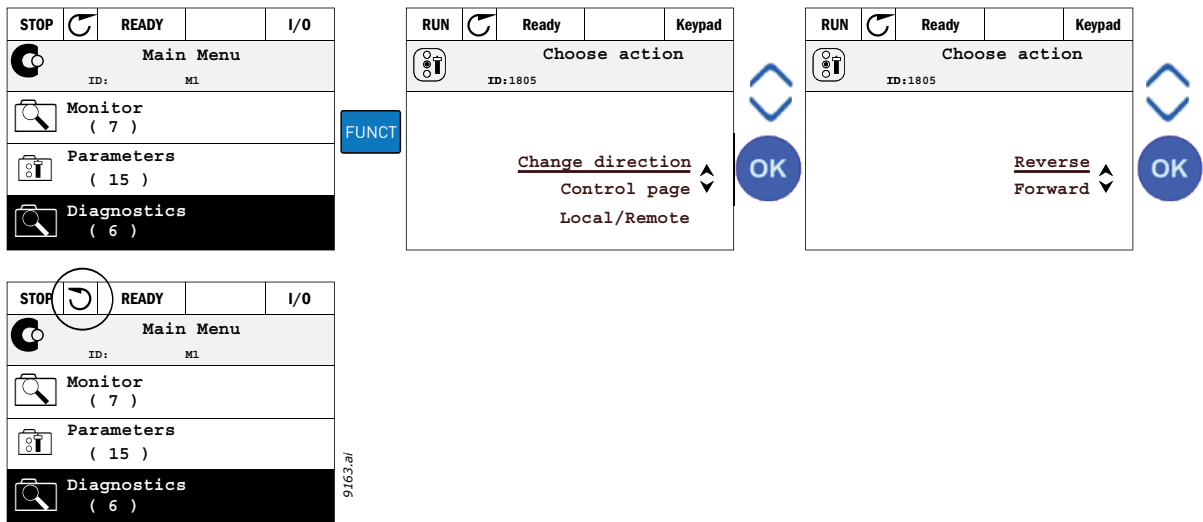

Figure 27.

Quick edit

Through the *Quick edit* functionality you can quickly access the desired parameter by entering the parameter's ID number.

1. Anywhere in the menu structure, push the FUNCT button.
2. Push the *Arrow up* or the *Arrow down* buttons to select Quick Edit and confirm with the OK button.
3. Then enter the ID number of parameter or monitoring value you wish to access. Press OK button to confirm.
4. Requested Parameter/Monitoring value appears on the display (in editing/monitoring mode.)

2.2.1.4 Copying parameters

NOTE! This feature is available in graphical keypad only.

The parameter copy function can be used to copy parameters from one drive to another.

The parameters are first saved to the keypad, then the keypad is detached and connected to another drive. Finally the parameters are downloaded to the new drive restoring them from the keypad.

Before any parameters can successfully be copied from the keypad to the drive, the drive **has to be stopped** before the parameters are uploaded.

- First go into *User settings* menu and locate the *Parameter backup* submenu. In the *Parameter backup* submenu, there are three possible functions to be selected:
- *Restore factory defaults* will re-establish the parameter settings originally made at the factory.
- By selecting *Save to keypad* you can copy all parameters to the keypad.
- *Restore from keypad* will copy all the parameters from the keypad to a drive.

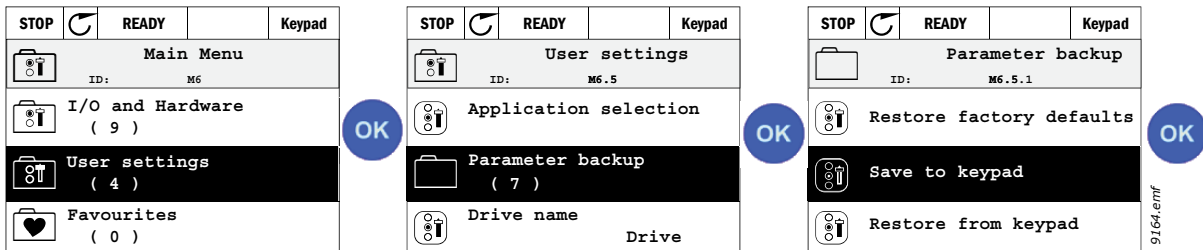

Figure 28. Parameter copy

NOTE! If the keypad is changed between drives of different sizes, the copied values of these parameters will not be used:

- Motor nominal current (P3.1.1.4)
- Motor nominal voltage (P3.1.1.1)
- Motor nominal speed (P3.1.1.3)
- Motor nominal power (P3.1.1.6)
- Motor nominal frequency (P3.1.1.2)
- Motor cos phii (P3.1.1.5)
- Switching frequency (P3.1.2.3)
- Motor current limit (P3.1.3.1)
- Stall current limit (P3.9.3.2)
- Maximum frequency (P3.3.1.2)
- Field weakening point frequency (P3.1.4.2)
- U/f midpoint frequency (P3.1.4.4)
- Zero frequency voltage (P3.1.4.6)
- Start magnetising current (P3.4.3.1)
- DC brake current (P3.4.4.1)
- Flux braking current (P3.4.5.2)
- Motor thermal time constant (P3.9.2.4)

2.2.1.5 Comparing parameters

With this function, the user can compare the active parameter set with one of these four sets:

- Set 1 (B6.5.4: Save to Set 1, see chapter 7.1.1)
- Set 2 (B6.5.6: Save to Set 2, see chapter 7.1.1)
- Defaults (Factory defaults, see chapter 7.1.1)
- Keypad set (B6.5.2: Save to Keypad, see chapter 7.1.1)

See the figure below.

NOTE! If the parameter set to be compared with has not been saved, the display shows: “Comparing failed”

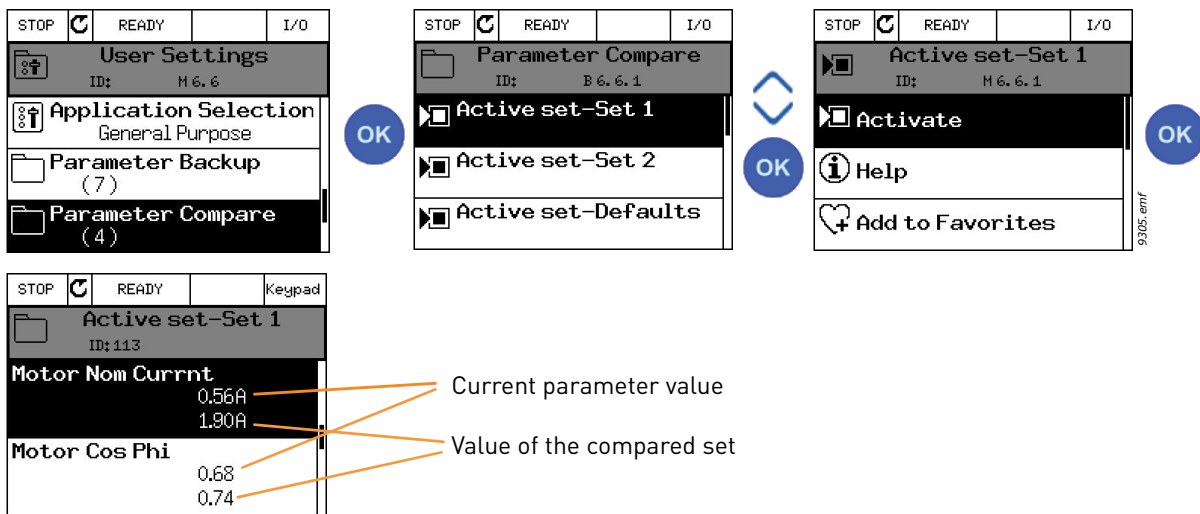

Figure 29. Parameter compare

2.2.1.6 Help texts

The graphical keypad features instant help and information displays for various items. All parameters offer an instant help display. Select Help and press the OK button.

Text information is also available for faults, alarms and the startup wizard.

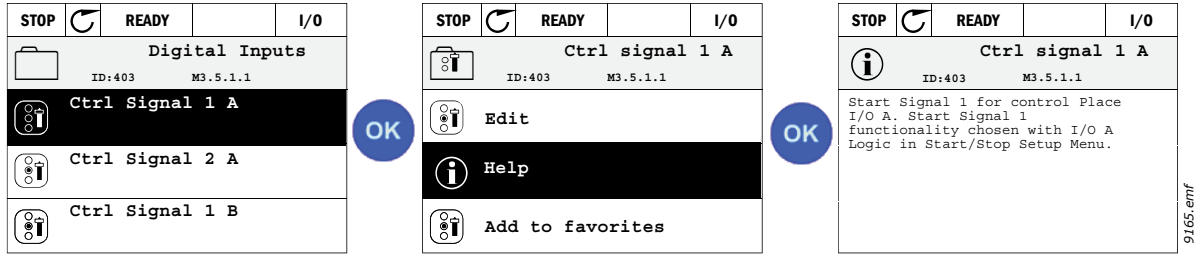

Figure 30. Help text example

2.3 VACON TEXT KEYPAD

You can also choose a so-called *Text keypad* for your user interface. It has mainly the same functionalities as the graphical keypad, although some of the functionalities are somewhat limited.

2.3.1 KEYPAD DISPLAY

The keypad display indicates the status of the motor and the drive and any irregularities in the motor or drive functions. On the display, the user sees information about the drive and the present location in the menu structure and the item displayed. If the text on the text line is too long to fit in the display, the text will scroll from left to right to reveal the whole text string.

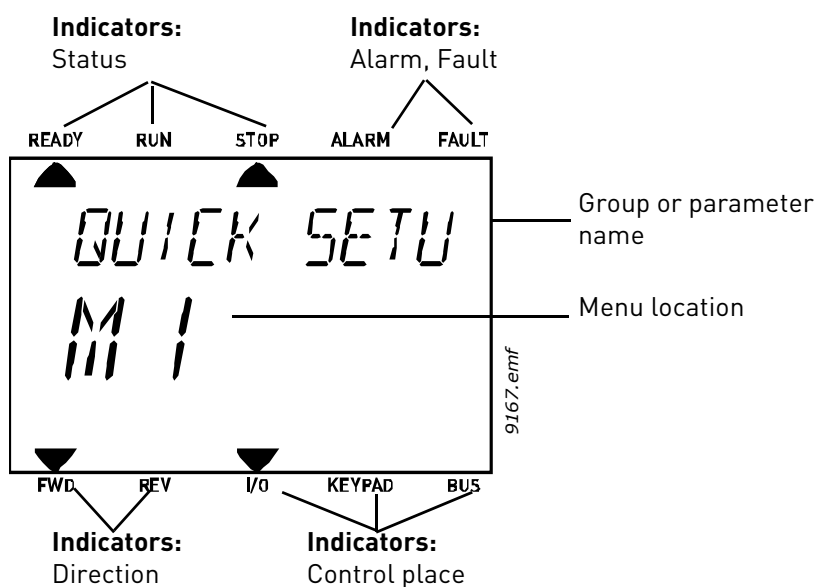

Figure 31.

2.3.2 USING THE TEXT KEYPAD

2.3.2.1 Editing the values

Change the value of a parameter by following the procedure below:

1. Locate the parameter.
2. Enter the Edit mode by pressing OK.
3. Set new value with the arrow buttons Up/Down. You can also move from digit to digit with the arrow buttons Left/Right if the value is numerical and change then the value with the arrow buttons Up/Down.
4. Confirm the change with OK button or ignore the change by returning to previous level with Back/Reset button.

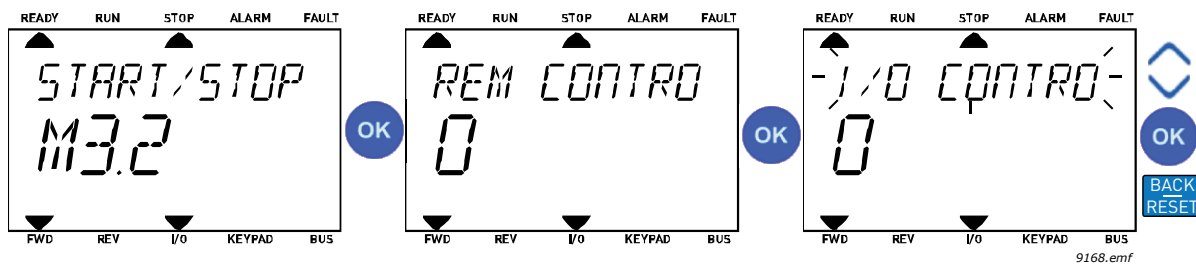

Figure 32. Editing values

2.3.2.2 Resetting fault

Instructions for how to reset a fault can be found in 9.1 Fault appears.

2.3.2.3 Function button

The FUNCT button is used for four functions:

Control places

The *control place* is the source of control, where the drive can be started and stopped. Every control place has its own parameter for selecting the frequency reference source. The *Local control place* is always the keypad. The *Remote control place* is determined by parameter P3.2.1 (I/O or Fieldbus). The selected control place can be seen on the status bar of the keypad.

Remote control place

I/O A, I/O B and Fieldbus can be used as remote control places. I/O A and Fieldbus have the lowest priority and can be chosen with parameter P3.2.1 (*Rem Control Place*). I/O B, again, can bypass the remote control place selected with parameter P3.2.1 using a digital input. The digital input is selected with parameter P3.5.1.7 (*I/O B Ctrl Force*).

Local control

Keypad is always used as the control place while in local control. Local control has higher priority than remote control. Therefore, if, for example, bypassed by parameter P3.5.1.7 through digital input while in *Remote*, the control place will still switch to Keypad, if *Local* is selected. Switching between Local and Remote Control is made by pressing the FUNCT button on the keypad or by using the "Local/Remote" (ID211) parameter.

Changing control places

Change of control place from *Remote* to *Local* (keypad).

1. Anywhere in the menu structure, push the FUNCT button.
2. Using the arrow buttons, select Local/Remote and confirm with the OK button.
3. On the next display, select Local or Remote and again confirm with the OK button.
4. The display will return to the same location as it was when the FUNCT button was pushed. However, if the Remote control place was changed to Local (Keypad) you will be instructed to keypad reference.

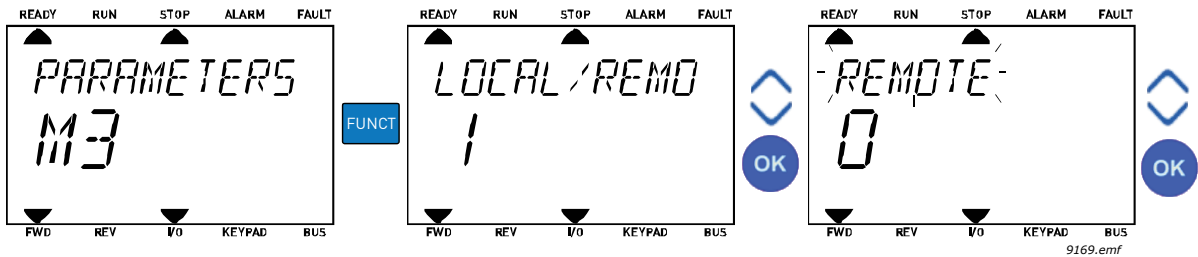

Figure 33. Changing control places

Accessing the control page

The *Control page* is meant for easy operation and monitoring of the most essential values.

1. Anywhere in the menu structure, push the FUNCT button.
2. Push the *Arrow up* or the *Arrow down* button to select *Control page* and confirm with the OK button.
3. The control page appears
 If the keypad control place and the keypad reference are selected to be used, you can set the *Keypad reference* after having pressed the OK button. If other control places or reference values are used, the display will show Frequency reference, which is not editable.

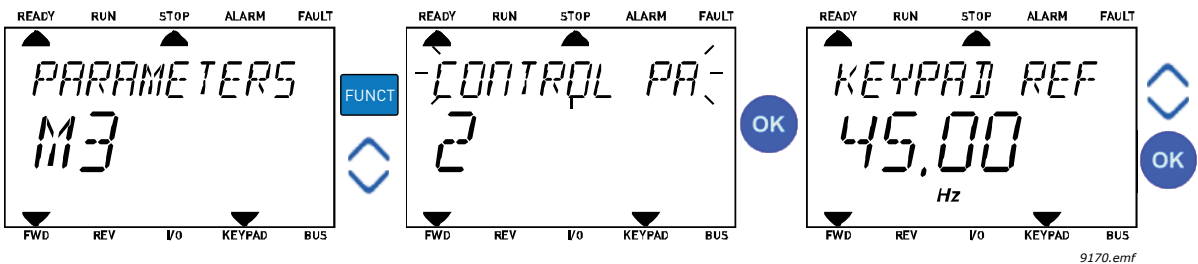

Figure 34. Accessing Control page

Changing direction

Rotation direction of the motor can quickly be changed by applying the FUNCT button.

NOTE! *Changing direction* command is not visible in the menu unless the selected control place is *Local*.

1. Anywhere in the menu structure, push the FUNCT button.
2. Push the *Arrow up* or the *Arrow down* button to select Change direction and confirm with the OK button.
3. Then choose the direction you wish to run the motor to. The actual rotation direction is blinking. Confirm with the OK button.
4. The rotation direction changes immediately and the arrow indication in the status field changes.

Quick edit

Through the *Quick edit* functionality you can quickly access the desired parameter by entering the parameter's ID number.

1. Anywhere in the menu structure, push the FUNCT button.
2. Push the *Arrow up* or the *Arrow down* buttons to select Quick Edit and confirm with the OK button.
3. Then enter the ID number of parameter or monitoring value you wish to access. Press OK button to confirm.
4. Requested Parameter/Monitoring value appears on the display (in editing/monitoring mode).

2.4 MENU STRUCTURE

Table 1. Keypad menus

Quick setup	See chapter 1.
Monitor	Multi-monitor*
	Trend curve*
	Basic
	I/O
	Extras/Advanced
	Timer functions
	PID Controller
	External PID controller
	Multipump
	Maintenance counters
Fieldbus data	
Parameters	See chapter 8.
Diagnostics	Active faults
	Reset faults
	Fault history
	Total counters
	Trip counters
	Software info
I/O and hardware	User settings
	Slot C
	Slot D
	Slot E
	Real time clock
	Power unit settings
	Keypad
	RS-485
	Ethernet
User settings	Language selections
	Parameter backup*
	Parameter compare
	Drive name
Favorites*	See chapter 7.2.
User levels	See chapter 7.3.

*. Not available in text keypad

2.4.1 QUICK SETUP

The Quick Setup group includes the different wizards and quick setup parameters of the Vacon® 100 Application. More detailed information on the parameters of this group you will find in chapter 1.

2.4.2 MONITOR

Multi-monitor

NOTE! This menu is not available in text keypad.

On the multi-monitor page, you can collect four to nine values that you wish to monitor. The number of the monitored items can be selected with parameter 3.11.4.

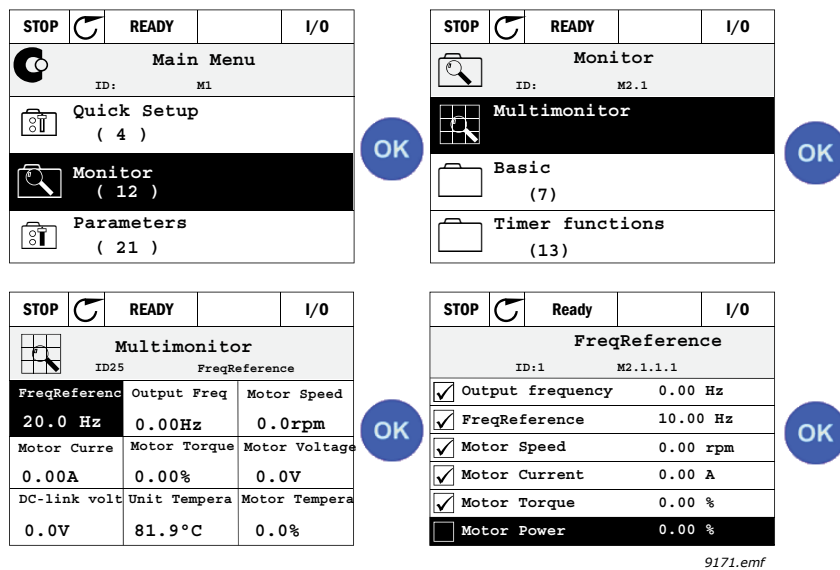

Figure 35. Multi-monitoring page

Change the monitored value by activating the value cell (with arrow buttons left/right) and clicking OK. Then choose a new item on the Monitoring values list and click OK again.

Trend curve

The *Trend Curve* feature is a graphical presentation of two monitor values at a time.

Basic

The basic monitoring values are the actual values of selected parameters and signals as well as statuses and measurements.

I/O

Statuses and levels of various input and output signal values can be monitored here. See chapter 3.1.4.

Temperature inputs

see chapter 3.1.5

Extras/Advanced

Monitoring of different advanced values, e.g. fieldbus values. See chapter 3.1.6.

Timer functions

Monitoring of timer functions and the Real Time Clock. See chapter 3.1.7.

PID Controller

Monitoring of PID controller values. See chapter 3.1.8.

External PID controller

Monitoring of external PID controller values. See chapter 3.1.9.

Multipump

Monitoring of values related to the use of several drives. See chapter 3.1.10.

Maintenance counters

Monitoring of values related to Maintenance counters. See chapter 3.1.11.

Fieldbus data

Fieldbus data shown as monitor values for debugging purposes at e.g. fieldbus commissioning. See chapter 3.1.12.

2.5 VACON LIVE

Vacon Live is a PC-tool for commissioning and maintenance of new generation drives (Vacon10, Vacon20, Vacon100). Vacon Live tool can be downloaded from www.vacon.com.

Vacon Live includes the following features:

- Parametrisation, monitoring, drive info, data logger, etc.
- Software download tool Vacon Loader is integrated.
- Support for RS-422 and Ethernet
- Windows 7 support
- Languages supported: English, German, Spanish, Finnish, French, Italian, Russian, Swedish, Chinese, Czech, Danish, Dutch, Polish, Portuguese, Romanian, Slovak and Turkish.
- Connection can be made by using Vacon's black USB/RS-422 cable or Ethernet cable (Vacon 100)
- RS-422 drivers are installed automatically during the Vacon Live installation.
- When the connection is made, Vacon Live finds the connected drive automatically

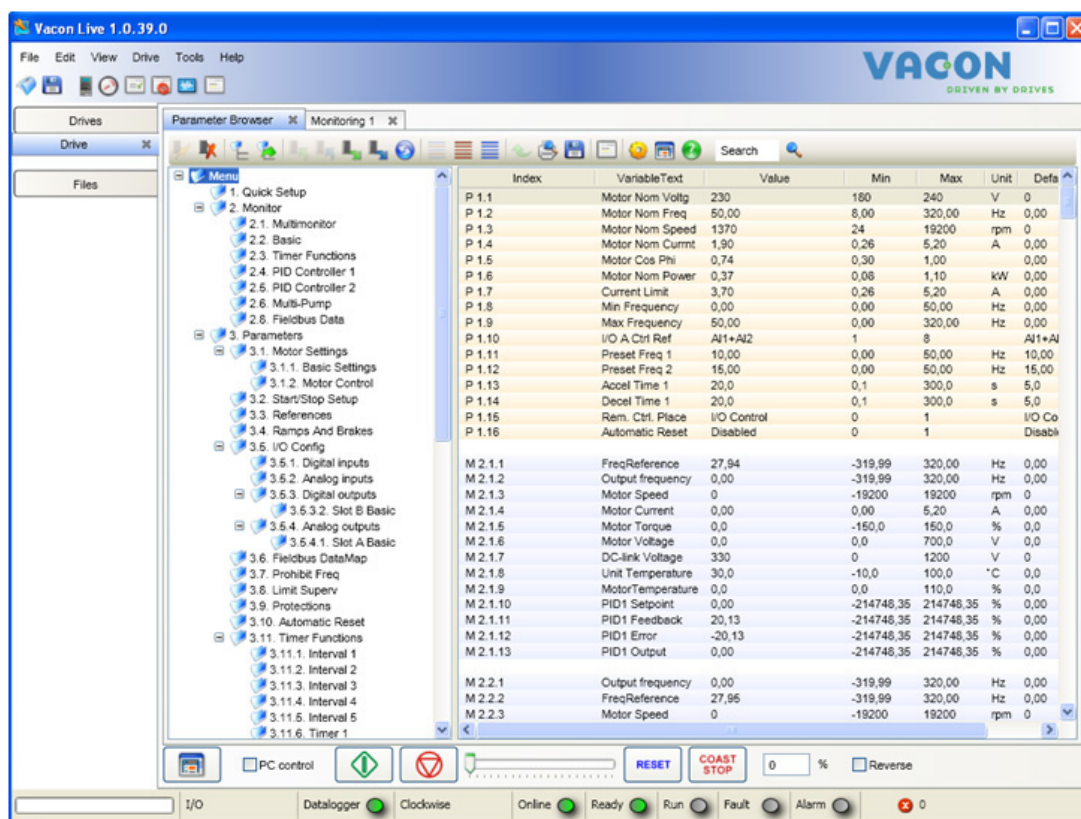

Figure 36. Vacon Live - main window

NOTE! Find more information on using Vacon Live in the program help

3. MONITORING MENU

3.1 MONITOR GROUP

The AC drive provides you with a possibility to monitor the actual values of parameters and signals as well as statuses and measurements. Some of the values to be monitored are customisable.

3.1.1 MULTIMONITOR

On the multi-monitor page you can collect four to nine values that you wish to monitor. The number of the monitored items can be selected with parameter P3.11.4. See Table 50 for more information.

STOP	↺	READY		I/O
 Multimonitor ID: 25 V 2.1.1				
FreqReference		Output frequency		
0.00Hz		0.00Hz		
Motor Current		Motor Speed		
0.00A		0rpm		
Motor Torque		Motor Power		
0.0%		0.0%		

3100.emf

Figure 37.

3.1.2 TREND CURVE

The *Trend Curve* feature is a graphical presentation of two monitor values at a time.

Selecting values to monitor starts logging the values. In the Trend curve submenu, you can view the trend curve, make the signal selections, give the minimum and maximum settings, Sampling interval and choose whether to use Autoscaling or not.

Change values to monitor following the procedure below:

1. Locate the *Trend curve* menu in the *Monitor* menu and press OK.
2. Further enter the menu *View trend curve* by pressing OK again.
3. The current selections to monitor are *FreqReference* and *Motor speed* visible at the bottom of the display.
4. Only two values can be monitored as trend curves simultaneously. Select the one of the current values you wish to change with the arrow buttons and press OK.
5. Browse the list of given monitoring values with the arrow buttons, select the one you wish and press OK.
6. The trend curve of the changed value can be seen on the display.

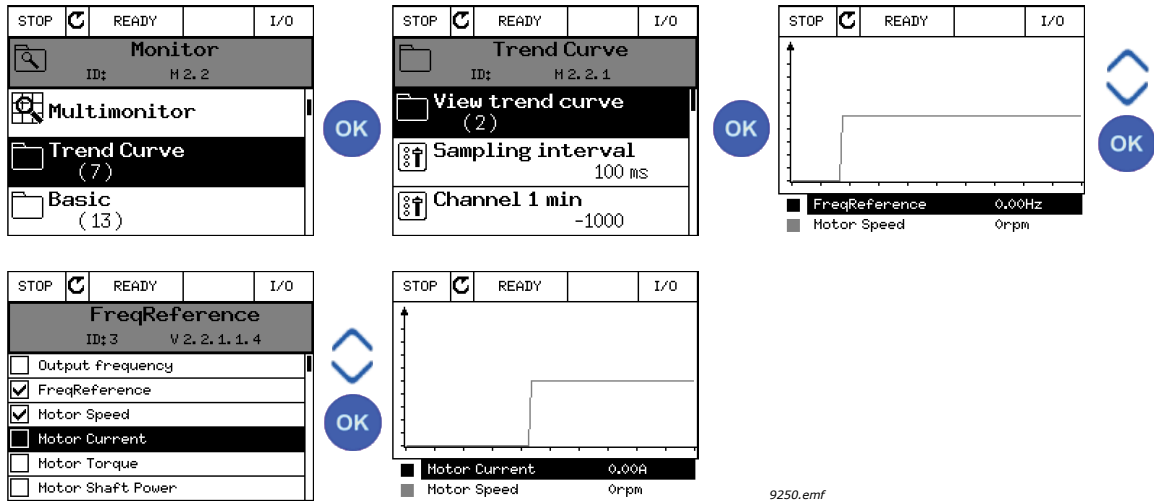

Figure 38.

The *Trend Curve* feature also allows you to halt the progression of the curve and read the exact individual values.

1. In Trend curve view, select the display with the arrow button up (the frame of the display turns bold) and press OK at the desired point of the progressing curve. A vertical hairline appears on the display.
2. The display freezes and the values at the bottom of the display correspond to the location of the hairline.
3. Use the arrow buttons left and right to move the hairline to see the exact values of some other location.

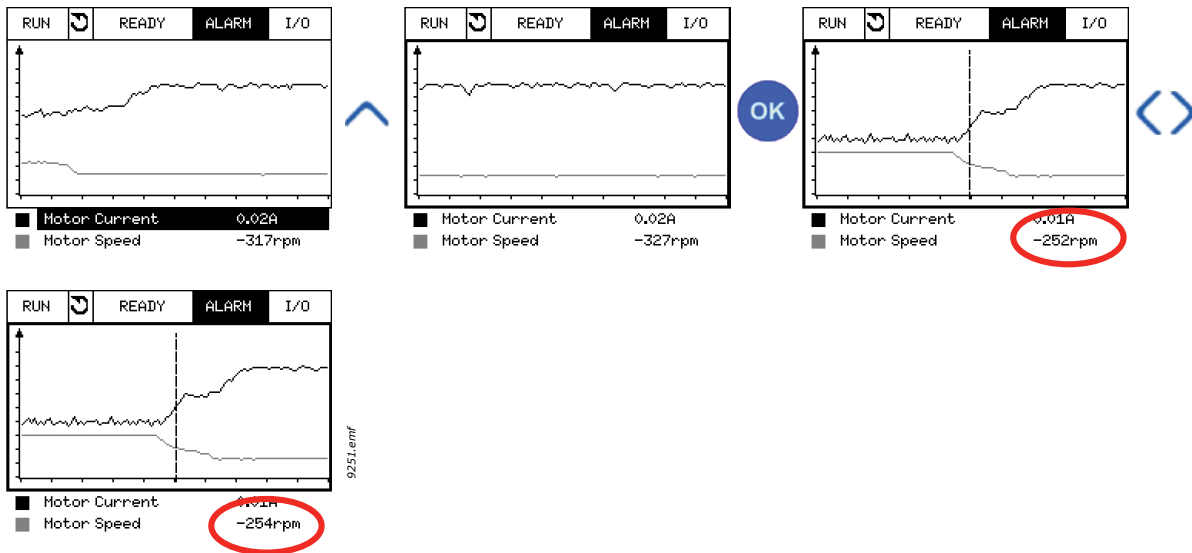

Figure 39.

Table 2. Trend curve parameters

Index	Parameter	Min	Max	Unit	Default	ID	Description
M2.2.1	View Trend curve						Enter this menu to select and monitor values for viewing in curve form.
P2.2.2	Sampling interval	100	432000	ms	100	2368	Set here the sampling interval.
P2.2.3	Channel 1 min	-214748	1000		-1000	2369	Used by default for scaling. Adjustments might be necessary.
P2.2.4	Channel 1 max	-1000	214748		1000	2370	Used by default for scaling. Adjustments might be necessary.
P2.2.5	Channel 2 min	-214748	1000		-1000	2371	Used by default for scaling. Adjustments might be necessary.
P2.2.6	Channel 2 max	-1000	214748		1000	2372	Used by default for scaling. Adjustments might be necessary.
P2.2.7	Autoscale	0	1		0	2373	The selected signal is automatically scaled between min and max values if this parameter is given value 1.

3.1.3 BASIC

The basic monitoring values are presented in Table 3. below.

NOTE! Only standard I/O board statuses are available in the Monitor menu. Statuses for all I/O board signals can be found as raw data in the I/O and Hardware system menu.

NOTE! Check expander I/O board statuses when required in the I/O and Hardware system menu.

Table 3. Monitoring menu items

Index	Monitoring value	Unit	Scale	ID	Description
V2.3.1	Output frequency	Hz	0.01	1	Output frequency to motor
V2.3.2	Frequency reference	Hz	0.01	25	Frequency reference to motor control
V2.3.3	Motor speed	rpm	1	2	Motor actual speed in rpm
V2.3.4	Motor current	A	Varies	3	
V2.3.5	Motor torque	%	0.1	4	Calculated shaft torque
V2.3.7	Motor shaft power	%	0.1	5	Calculated motor shaft power in %
V2.3.8	Motor shaft power	kW/hp	Varies	73	Calculated motor shaft power in kW or hp. Units depends on the unit selection parameter.
V2.3.9	Motor voltage	V	0.1	6	Output voltage to motor
V2.3.10	DC link voltage	V	1	7	Measured voltage in the drive's DC-link
V2.3.11	Unit temperature	°C/F	0.1	8	Heatsink temperature in °C or °F
V2.3.12	Motor temperature	%	0.1	9	Calculated motor temperature in percent of nominal working temperature.
V2.3.13	Motor Preheat		1	1228	Status of Motor preheat function. 0 = OFF 1 = Heating (feeding DC-current)

3.1.4 I/O

Table 4. I/O signal monitoring

Index	Monitoring value	Unit	Scale	ID	Description
V2.4.1	Slot A DIN 1, 2, 3		1	15	Shows the status of digital inputs 1-3 in slot A (standard I/O)
V2.4.2	Slot A DIN 4, 5, 6		1	16	Shows the status of digital inputs 4-6 in slot A (standard I/O)
V2.4.3	Slot B RO 1, 2, 3		1	17	Shows the status of relay inputs 1-3 in slot B
V2.4.4	Analogue input 1	%	0.01	59	Input signal in percent of used range. Slot A.1 as default.
V2.4.5	Analogue input 2	%	0.01	60	Input signal in percent of used range. Slot A.2 as default.
V2.4.6	Analogue input 3	%	0.01	61	Input signal in percent of used range. Slot D.1 as default.
V2.4.7	Analogue input 4	%	0.01	62	Input signal in percent of used range. Slot D.2 as default.
V2.4.8	Analogue input 5	%	0.01	75	Input signal in percent of used range. Slot E.1 as default.
V2.4.9	Analogue input 6	%	0.01	76	Input signal in percent of used range. Slot E.2 as default.
V2.4.10	Slot A A01	%	0.01	81	Analogue output signal in percent of used range. Slot A (standard I/O)

3.1.5 TEMPERATURE INPUTS

NOTE! This parameter group is visible only with an option board for temperature measurement (OPT-BH) installed.

Table 5. Monitored values of temperature inputs

Index	Monitoring value	Unit	Scale	ID	Description
V2.5.1	Temperature input 1	°C/F	0.1	50	Measured value of Temperature input 1. The list of temperature inputs is formed of 6 first available temperature inputs starting from slot A continuing to slot E. If the input is available but no sensor is connected the maximum value is shown because measured resistance is endless. The value can be forced to its min value instead by hardwiring the input.
V2.5.2	Temperature input 2	°C/F	0.1	51	Measured value of Temperature input 2. See above.
V2.5.3	Temperature input 3	°C/F	0.1	52	Measured value of Temperature input 3. See above.
V2.5.4	Temperature input 4	°C/F	0.1	69	Measured value of Temperature input 4. See above.
V2.5.5	Temperature input 5	°C/F	0.1	70	Measured value of Temperature input 5. See above.
V2.5.6	Temperature input 6	°C/F	0.1	71	Measured value of Temperature input 6. See above.

3.1.6 EXTRAS AND ADVANCED

Table 6. Advanced values monitoring

Index	Monitoring value	Unit	Scale	ID	Description
V2.6.1	Drive Status Word		1	43	Bit coded word B1=Ready B2=Run B3=Fault B6=RunEnable B7=AlarmActive B10=DC Current in stop B11=DC Brake Active B12=RunRequest B13=MotorRegulatorActive
V2.6.2	Ready status		1	78	Bit coded information about ready criteria. Useful for debugging when the drive is not in ready status. Values are visible as checkboxes on graphical keypad. If checked (☑), the value is active. B0: RunEnable high B1: No fault active B2: Charge switch closed B3: DC voltage within limits B4: Power manager initialised B5: Power unit is not blocking start B6: System software is not blocking start
V2.6.3	Application Status Word1		1	89	Bit coded statuses of application. Values are visible as checkboxes on graphical keypad. If checked (☑), the value is active. B0=Interlock 1 B1=Interlock 2 B2=Reserved B3=Ramp 2 active B4=Reserved B5=I/O A control active B6=I/O B control active B7=Fieldbus Control Active B8=Local control active B9=PC control active B10=Preset frequencies active B11=Flushing active B12=Fire Mode active B13=Motor Preheat active B14=Quick stop active B15=Drive stopped from keypad

Table 6. Advanced values monitoring

Index	Monitoring value	Unit	Scale	ID	Description
V2.6.4	Application Status Word2		1	90	Bit coded status of application. Values are visible as checkboxes on graphical keypad. If checked (☑), the value is active. B0=Acc/Dec prohibited B1=Motor switch open B2=PID active B3=PID Sleep active B4=PID Soft fill active B5=Autocleaning active B6=Jockey pump active B7=Priming pump active B8=Anti-blocking active B9=Input pressure supervision (Alarm/Fault) B10=Frost protection (Alarm/Fault) B11=Overpressure alarm
V2.6.5	DIN Status Word 1		1	56	16-bit word where each bit represents the status of one digital input. 6 digital inputs from every slot are read. Word 1 starts from input 1 in slot A (bit0) and goes all the way to input 4 in slot C (bit15).
V2.6.6	DIN Status Word 2		1	57	16-bit word where each bit represents the status of one digital input. 6 digital inputs from every slot are read. Word 1 starts from input 5 in slot C (bit0) and goes all the way to input 6 in slot E (bit13).
V2.6.7	Motor current 1 decimal		0.1	45	Motor current monitor value with fixed number of decimals and less filtering. Can be used e.g. for fieldbus purposes to always get the right value regardless of frame size, or for monitoring when less filtering time is needed for the motor current.
V2.6.8	Frequency reference source		1	1495	Shows the momentary frequency reference source. 0=PC 1=Preset Freqs 2=Keypad Reference 3=Fieldbus 4=A11 5=A12 6=A11+A12 7=PID Controller 8=Motor Potentiom. 10=Flushing 100=Not defined 101=Alarm,PresetFreq 102=Autocleaning
V2.6.9	Last active fault code		1	37	The fault code of latest activated fault that has not been reset.
V2.6.10	Last active fault ID		1	95	The fault ID of latest activated fault that has not been reset.
V2.6.11	Last active alarm code		1	74	The alarm code of latest activated alarm that has not been reset.
V2.6.12	Last active alarm ID		1	94	The alarm ID of latest activated alarm that has not been reset.

Table 6. Advanced values monitoring

Index	Monitoring value	Unit	Scale	ID	Description
V2.6.13	Motor regulator status		min= 0, max= 65535	77	B0= Current limit (motor) B1= Current limit (generator) B2= Torque limit (motor) B3= Torque limit (generator) B4= Overvoltage control B5= Undervoltage control B6= Power limit (motor) B7= Power limit (generator)

3.1.7 TIMER FUNCTIONS MONITORING

Here you can monitor values of timer functions and the Real Time Clock.

Table 7. Monitoring of timer functions

Index	Monitoring value	Unit	Scale	ID	Description
V2.7.1	TC 1, TC 2, TC 3		1	1441	Possible to monitor the statuses of the three Time Channels (TC)
V2.7.2	Interval 1		1	1442	Status of timer interval
V2.7.3	Interval 2		1	1443	Status of timer interval
V2.7.4	Interval 3		1	1444	Status of timer interval
V2.7.5	Interval 4		1	1445	Status of timer interval
V2.7.6	Interval 5		1	1446	Status of timer interval
V2.7.7	Timer 1	s	1	1447	Remaining time on timer if active
V2.7.8	Timer 2	s	1	1448	Remaining time on timer if active
V2.7.9	Timer 3	s	1	1449	Remaining time on timer if active
V2.7.10	Real time clock			1450	hh:mm:ss

3.1.8 PID CONTROLLER MONITORING

Table 8. PID-controller value monitoring

Index	Monitoring value	Unit	Scale	ID	Description
V2.8.1	PID1 setpoint	Varies	According to P3.13.1.7	20	PID controller setpoint value in process units. Process unit is selected with a parameter.
V2.8.2	PID1 feedback	Varies	According to P3.13.1.7	21	PID controller feedback value in process units. Process unit is selected with a parameter.
V2.8.3	PID1 error value	Varies	According to P3.13.1.7	22	PID controller error value. Deviation of feedback from setpoint in process units. Process unit is selected with a parameter.
V2.8.4	PID1 output	%	0.01	23	PID output in percent (0..100%). This value can be fed e.g. to Motor Control (Frequency reference) or Analogue output
V2.8.5	PID1 status		1	24	0=Stopped 1=Running 3=Sleep mode 4=In dead band (see ch 4.13.1)

3.1.9 EXTERNAL PID CONTROLLER MONITORING

Table 9. External PID-controller value monitoring

Index	Monitoring value	Unit	Scale	ID	Description
V2.9.1	ExtPID setpoint	Varies	According to P3.14.1.10	83	External PID controller setpoint value in process units. Process unit is selected with a parameter.
V2.9.2	ExtPID feedback	Varies	According to P3.14.1.10	84	External PID controller feedback value in process units. Process unit is selected with a parameter.
V2.9.3	ExtPID error value	Varies	According to P3.14.1.10	85	External PID controller Error value. Deviation of feedback from setpoint in process units. Process unit is selected with a parameter.
V2.9.4	ExtPID output	%	0.01	86	External PID controller output in percent (0..100%). This value can be fed e.g. to Analogue output.
V2.9.5	ExtPID status		1	87	0=Stopped 1=Running 2=In dead band (see ch 4.13.1)

3.1.10 MULTIPUMP MONITORING

NOTE! Pump runtime monitoring values 'Pump 2 Running Time'...'Pump 8 Running Time' are used only in Multipump (Single drive) mode.

If Multimaster or Multifollower -modes are used, the pump runtime counter value is read from 'Pump (1) Running Time'. Each pump runtime has to be read individually from each drive.

Table 10. Multipump monitoring

Index	Monitoring value	Unit	Scale	ID	Description
V2.10.1	Motors running		1	30	The number of motors running when Multipump function is used.
V2.10.2	Autochange		1	1113	Informs the user if autochange is requested.
V2.10.3	Multipump Status		0 - 65535	15507	Status of the drive when the drive is operating in Multipump system. bit1 = Run Request active bit2 = Run command active bit3 = Interlock 1 bit4 = Multipump -function enabled bit5 = Drive operation mode: Auxiliary drive bit6 = Drive operation mode: Leading drive bit9 = Multipump mode: Single drive bit10 = Multipump mode: Multifollower bit11 = Multipump mode: Multimaster bit12 = Drive is regulating bit13 = Drive is following bit14 = Drive is running at constant prod. speed

Table 10. Multipump monitoring

Index	Monitoring value	Unit	Scale	ID	Description
V2.10.4	Communication Status		0 - 65535	15506	Status of drive-to-drive communication in Multipump (Multidrive) system. Shows which drives are communicating with each other. bit1 = Drive 1 communicating bit2 = Drive 2 communicating bit3 = Drive 3 communicating bit4 = Drive 4 communicating bit5 = Drive 5 communicating bit6 = Drive 6 communicating bit7 = Drive 7 communicating bit8 = Drive 8 communicating
V2.10.5	Pump (1) Running Time	h	0-300000	15510	SingleDrive -mode: Pump 1 operating hours. MultiDrive -mode: Operating hours of this drive (this pump).
V2.10.6	Pump (2) Running Time	h	0-300000	15511	SingleDrive -mode: Pump 2 operating hours. MultiDrive -mode: Operating hours of this drive (this pump).
V2.10.7	Pump (3) Running Time	h	0-300000	15512	SingleDrive -mode: Pump 3 operating hours. MultiDrive -mode: Operating hours of this drive (this pump).
V2.10.8	Pump (4) Running Time	h	0-300000	15513	SingleDrive -mode: Pump 4 operating hours. MultiDrive -mode: Operating hours of this drive (this pump).
V2.10.9	Pump (5) Running Time	h	0-300000	15514	SingleDrive -mode: Pump 5 operating hours. MultiDrive -mode: Operating hours of this drive (this pump).
V2.10.10	Pump (6) Running Time	h	0-300000	15515	SingleDrive -mode: Pump 6 operating hours. MultiDrive -mode: Operating hours of this drive (this pump).
V2.10.11	Pump (7) Running Time	h	0-300000	15516	SingleDrive -mode: Pump 7 operating hours. MultiDrive -mode: Operating hours of this drive (this pump).
V2.10.12	Pump (8) Running Time	h	0-300000	15517	SingleDrive -mode: Pump 8 operating hours. MultiDrive -mode: Operating hours of this drive (this pump).

3.1.11 MAINTENANCE COUNTERS

Table 11. Maintenance counter monitoring

Index	Monitoring value	Unit	Scale	ID	Description
V2.11.1	Maintenance counter 1	h/ kRev	Varies	1101	Status of maintenance counter in revolutions multiplied by 1000, or hours. For configuration and activation of this counter, see chapter 4.16.

3.1.12 FIELDBUS DATA MONITORING

Table 12. Fieldbus data monitoring

Index	Monitoring value	Unit	Scale	ID	Description
V2.12.1	FB Control Word		1	874	Fieldbus control word used by application in bypass mode/format. Depending on the fieldbus type or profile the data can be modified before sent to application.
V2.12.2	FB speed reference		Varies	875	Speed reference scaled between minimum and maximum frequency at the moment it was received by the application. Minimum and maximum frequencies can be changed after the reference was received without affecting the reference.
V2.12.3	FB data in 1		1	876	Raw value of process data in 32-bit signed format
V2.12.4	FB data in 2		1	877	Raw value of process data in 32-bit signed format
V2.12.5	FB data in 3		1	878	Raw value of process data in 32-bit signed format
V2.12.6	FB data in 4		1	879	Raw value of process data in 32-bit signed format
V2.12.7	FB data in 5		1	880	Raw value of process data in 32-bit signed format
V2.12.8	FB data in 6		1	881	Raw value of process data in 32-bit signed format
V2.12.9	FB data in 7		1	882	Raw value of process data in 32-bit signed format
V2.12.10	FB data in 8		1	883	Raw value of process data in 32-bit signed format
V2.12.11	FB Status Word		1	864	Fieldbus status word sent by application in bypass mode/format. Depending on the FB type or profile the data can be modified before sent to the FB.
V2.12.12	FB speed actual		0.01	865	Actual speed in %. 0 and 100% correspond to minimum and maximum frequencies respectively. This is continuously updated depending on the momentary min and max frequencies and the output frequency.
V2.12.13	FB data out 1		1	866	Raw value of process data in 32-bit signed format
V2.12.14	FB data out 2		1	867	Raw value of process data in 32-bit signed format
V2.12.15	FB data out 3		1	868	Raw value of process data in 32-bit signed format
V2.12.16	FB data out 4		1	869	Raw value of process data in 32-bit signed format
V2.12.17	FB data out 5		1	870	Raw value of process data in 32-bit signed format
V2.12.18	FB data out 6		1	871	Raw value of process data in 32-bit signed format
V2.12.19	FB data out 7		1	872	Raw value of process data in 32-bit signed format
V2.12.20	FB data out 8		1	873	Raw value of process data in 32-bit signed format

4. PARAMETERS MENU

4.1 GROUP 3.1: MOTOR SETTINGS

4.1.1 MOTOR NAMEPLATE PARAMETERS

Table 13. Motor nameplate parameters

Index	Parameter	Min	Max	Unit	Default	ID	Description
P3.1.1.1	Motor nominal voltage	Varies	Varies	V	Varies	110	Find this value U_n on the rating plate of the motor. Note also used connection (Delta/Star).
P3.1.1.2	Motor nominal frequency	8.00	320.00	Hz	50.0/60.0	111	Find this value f_n on the rating plate of the motor.
P3.1.1.3	Motor nominal speed	24	19200	rpm	Varies	112	Find this value n_n on the rating plate of the motor.
P3.1.1.4	Motor nominal current	$I_H * 0.1$	$I_H * 0.1$	A	I_S	113	Find this value I_n on the rating plate of the motor.
P3.1.1.5	Motor Cos Phi	0.30	1.00		Varies	120	Find this value on the rating plate of the motor
P3.1.1.6	Motor nominal power	Varies	Varies	kW	Varies	116	Find this value P_n on the rating plate of the motor.

4.1.2 MOTOR CONTROL SETTINGS

Table 14. Motor control settings

Index	Parameter	Min	Max	Unit	Default	ID	Description
P3.1.2.2	Motor type	0	1		0	650	0 = Induction motor 1 = PM motor
P3.1.2.3	Switching frequency	1.5	Varies	kHz	Varies	601	Increasing the switching frequency reduces the capacity of the AC drive. It is recommended to use a lower frequency when the motor cable is long in order to minimise capacitive currents in the cable. Motor noise can also be minimised using a high switching frequency.
P3.1.2.4	Identification	0	2		0	631	The automatic motor identification calculates or measures the motor parameters that are needed for optimum motor and speed control. 0 = No action 1 = At standstill 2 = With rotation NOTE! Motor nameplate parameters in menu M3.1.1 Motor Nameplate have to be set before executing the identification.
P3.1.2.5	Magnetising current	0.0	2*I _H	A	0.0	612	Motor magnetising current (no-load current). The values of the U/f parameters are identified by the magnetising current if given before the identification run. If this value is set to zero, magnetising current will be internally calculated.
P3.1.2.6	Motor switch	0	1		0	653	Enabling this function prevents the drive from tripping when the motor switch is closed and opened e.g. using flying start. 0 = Disabled 1 = Enabled
P3.1.2.10	Overvoltage control	0	1		1	607	0 = Disabled 1 = Enabled
P3.1.2.11	Undervoltage control	0	1		1	608	0 = Disabled 1 = Enabled

Table 14. Motor control settings

Index	Parameter	Min	Max	Unit	Default	ID	Description
P3.1.2.12	Energy optimisation	0	1		0	666	The drive searches for the minimum motor current in order to save energy and to lower the motor noise. This function can be used e.g. in fan and pump applications but not suitable for fast PID controlled processes. 0 = Disabled 1 = Enabled
P3.1.2.13	Stator voltage adjust	50.0	150.0	%	100.0	659	Parameter for adjusting the stator voltage in permanent magnet motors.

4.1.3 MOTOR LIMIT SETTINGS

Table 15. Motor limit settings

Index	Parameter	Min	Max	Unit	Default	ID	Description
P3.1.3.1	Motor current limit	$I_H * 0.1$	I_S	A	Varies	107	Maximum motor current from AC drive
P3.1.3.2	Motor torque limit	0.0	300.0	%	300.0	1287	Maximum motoring side torque limit

4.1.4 OPEN LOOP SETTINGS

Table 16. Open loop settings

Index	Parameter	Min	Max	Unit	Default	ID	Description
P3.1.4.1	U/f ratio	0	2		0	108	Type of U/f curve between zero frequency and the field weakening point. 0=Linear 1=Squared 2=Programmable
P3.1.4.2	Field weakening point frequency	8.00	P3.3.1.2	Hz	Varies	602	The field weakening point is the output frequency at which the output voltage reaches the field weakening point voltage
P3.1.4.3	Voltage at field weakening point	10.00	200.00	%	100.00	603	Voltage at field weakening point in % of motor nominal voltage
P3.1.4.4	U/f midpoint frequency	0.00	P3.1.4.2	Hz	Varies	604	Provided that the programmable U/f curve has been selected (par. P3.1.4.1), this parameter defines the middle point frequency of the curve.
P3.1.4.5	U/f midpoint voltage	0.0	100.0	%	100.0	605	Provided that the programmable U/f curve has been selected (par. P3.1.4.1), this parameter defines the middle point voltage of the curve.
P3.1.4.6	Zero frequency voltage	0.00	40.00	%	Varies	606	This parameter defines the zero frequency voltage of the U/f curve. The default value varies according to unit size.
P3.1.4.7	Flying start options	0	1		0	1590	Checkbox selection: B0 = Search shaft frequency only from same direction as frequency reference. B1 = Disable AC scanning B4 = Use frequency reference for initial guess B5 = Disable DC pulses
P3.1.4.8	Flying start scan current	0.0	100.0	%	45.0	1610	Defined in percentage of motor nominal current.
P3.1.4.9	Start boost	0	1		0	109	0=Disabled 1=Enabled
M3.1.4.12	I/f start	This menu includes three parameters. See table below.					

Table 17. I/f start parameters

Index	Parameter	Min	Max	Unit	Default	ID	Description
P3.1.4.12.1	I/f start	0	1		0	534	0 = Disabled 1 = Enabled
P3.1.4.12.2	I/f start frequency	0.0	P3.1.1.2	Hz	15.0	535	Output frequency limit below which the defined I/f start current is fed to motor.
P3.1.4.12.3	I/f start current	0.0	100.0	%	80.0	536	The current fed to the motor when the I/f start function is activated.

4.2 GROUP 3.2: START/STOP SETUP

Table 18. Start/Stop Setup menu

Index	Parameter	Min	Max	Unit	Default	ID	Description
P3.2.1	Remote control place	0	1		0	172	Selection of remote control place (start/stop). Can be used to change back to remote control from Vacon Live e.g. in case of a broken panel. 0=I/O control 1=Fieldbus control
P3.2.2	Local/Remote	0	1		0	211	Switch between local and remote control places 0=Remote 1=Local
P3.2.3	Keypad stop button	0	1		0	114	0=Stop button always enabled (Yes) 1=Limited function of Stop button (No)
P3.2.4	Start function	0	1		0	505	0=Ramping 1=Flying start
P3.2.5	Stop function	0	1		0	506	0=Coasting 1=Ramping
P3.2.6	I/O A start/stop logic	0	4		1	300	Logic = 0: Ctrl sgn 1 = Forward Ctrl sgn 2 = Backward Logic = 1: Ctrl sgn 1 = Forward (edge) Ctrl sgn 2 = Inverted Stop Ctrl sgn 3 = Bckwrđ (edge) Logic = 2: Ctrl sgn 1 = Forward (edge) Ctrl sgn 2 = Bckwrđ (edge) Logic = 3: Ctrl sgn 1 = Start Ctrl sgn 2 = Reverse Logic = 4: Ctrl sgn 1 = Start (edge) Ctrl sgn 2 = Reverse
P3.2.7	I/O B start/stop logic	0	4		1	363	See above.
P3.2.8	Fieldbus start logic	0	1		0	889	0=Rising edge required 1=State
P3.2.9	Start delay	0.00	60.00	s	0.00	524	The delay between the start command and the actual start of the drive can be given with this parameter.
P3.2.10	Remote to Local function	0	2		2	181	Choose whether to copy the Run state and Reference when changing from Remote to Local (keypad) control: 0 = Keep Run 1 = Keep Run & Reference 2 = Stop

4.3 GROUP 3.3: REFERENCES

4.3.1 FREQUENCY REFERENCE PARAMETERSJ

Table 19. Frequency reference parameters

Index	Parameter	Min	Max	Unit	Default	ID	Description
P3.3.1.1	Minimum frequency reference	0.00	P3.3.1.2	Hz	0.00	101	Minimum allowed frequency reference
P3.3.1.2	Maximum frequency reference	P3.3.1.1	320.00	Hz	50.00/ 60.00	102	Maximum allowed frequency reference
P3.3.1.3	Positive frequency reference limit	-320.0	320.0	Hz	320.00	1285	Final frequency reference limit for positive direction.
P3.3.1.4	Negative frequency reference limit	-320.0	320.0	Hz	-320.00	1286	Final frequency reference limit for negative direction. NOTE! This parameter can be used e.g. to prevent motor from running in reverse direction.
P3.3.1.5	I/O control reference A selection	0	20		6*	117	Selection of ref source when control place is I/O A 0=PC 1=Preset Frequency 0 2=Keypad Reference 3=Fieldbus 4=AI1 5=AI2 6=AI1+AI2 7=PID 8=Motor Potentiometer 11=Block 1 Out 12=Block 2 Out 13=Block 3 Out 14=Block 4 Out 15=Block 5 Out 16=Block 6 Out 17=Block 7 Out 18=Block 8 Out 19=Block 9 Out 20=Block 10 Out
P3.3.1.6	I/O control reference B selection	0	20		4	131	Selection of ref source when control place is I/O B. See above. NOTE! I/O B control place can only be forced active with digital input (P3.5.1.7).













Table 19. Frequency reference parameters

Index	Parameter	Min	Max	Unit	Default	ID	Description
P3.3.1.7	Keypad Ctrl Reference selection	0	20		1	121	Selection of ref source when control place is keypad: 0=PC 1=Preset Frequency 0 2=Keypad Reference 3=Fieldbus 4=AI1 5=AI2 6=AI1+AI2 7=PID 8=Motor Potentiometer 11=Block 1 Out 12=Block 2 Out 13=Block 3 Out 14=Block 4 Out 15=Block 5 Out 16=Block 6 Out 17=Block 7 Out 18=Block 8 Out 19=Block 9 Out 20=Block 10 Out
P3.3.1.8	Keypad reference	0.00	P3.3.1.2	Hz	0.00	184	The frequency reference can be adjusted on the keypad with this parameter.
P3.3.1.9	Keypad direction	0	1		0	123	Motor rotation when control place is keypad 0 = Forward 1 = Reverse
P3.3.1.10	Fieldbus control reference selection	0	20		2	122	Selection of ref source when control place is Fieldbus: 0=PC 1=Preset Frequency 0 2=Keypad Reference 3=Fieldbus 4=AI1 5=AI2 6=AI1+AI2 7=PID 8=Motor Potentiometer 11=Block 1 Out 12=Block 2 Out 13=Block 3 Out 14=Block 4 Out 15=Block 5 Out 16=Block 6 Out 17=Block 7 Out 18=Block 8 Out 19=Block 9 Out 20=Block 10 Out

*Default value depends on the selected application, see Appendix 1.

4.3.2 PRESET FREQUENCIES

Table 20. Preset frequencies parameters

Index	Parameter	Min	Max	Unit	Default	ID	Description
 P3.3.3.1	Preset frequency mode	0	1		0	182	0 = Binary coded 1 = Number of inputs. Preset frequency is selected according to how many of preset speed digital inputs are active
 P3.3.3.2	Preset frequency 0	P3.3.1.1	P3.3.1.2	Hz	5.00	180	Basic preset frequency 0 when selected by Control reference parameter (P3.3.1.5).
 P3.3.3.3	Preset frequency 1	P3.3.1.1	P3.3.1.2	Hz	10.00	105	Select with digital input: Preset frequency selection 0 (P3.3.3.10)
 P3.3.3.4	Preset frequency 2	P3.3.1.1	P3.3.1.2	Hz	15.00	106	Select with digital input: Preset frequency selection 1 (P3.3.3.11)
 P3.3.3.5	Preset frequency 3	P3.3.1.1	P3.3.1.2	Hz	20.00	126	Select with digital inputs: Preset frequency selection 0 & 1
 P3.3.3.6	Preset frequency 4	P3.3.1.1	P3.3.1.2	Hz	25.00	127	Select with digital input: Preset frequency selection 2 (P3.3.3.12)
 P3.3.3.7	Preset frequency 5	P3.3.1.1	P3.3.1.2	Hz	30.00	128	Select with digital inputs: Preset frequency selection 0 & 2
 P3.3.3.8	Preset frequency 6	P3.3.1.1	P3.3.1.2	Hz	40.00	129	Select with digital inputs: Preset frequency selection 1 & 2
 P3.3.3.9	Preset frequency 7	P3.3.1.1	P3.3.1.2	Hz	50.00	130	Select with digital inputs: Preset frequency selection 0 & 1 & 2
 P3.3.3.10	Preset frequency selection 0				DigIN SlotA.4	419	Binary selector for Preset speeds (0-7). See parameters P3.3.3.2 to P3.3.3.9.
 P3.3.3.11	Preset frequency selection 1				DigIN SlotA.5	420	Binary selector for Preset speeds (0-7). See parameters P3.3.3.2 to P3.3.3.9.
 P3.3.3.12	Preset frequency selection 2				DigIN Slot0.1	421	Binary selector for Preset speeds (0-7). See parameters P3.3.3.2 to P3.3.3.9.

4.3.3 MOTOR POTENTIOMETER PARAMETERS

Table 21. Motor potentiometer parameters

Index	Parameter	Min	Max	Unit	Default	ID	Description
P3.3.4.1	Motor potentiometer UP				DigIN Slot0.1	418	FALSE = Not active TRUE = Active (Motor potentiometer reference INCREASES until the contact is opened)
P3.3.4.2	Motor potentiometer DOWN				DigIN Slot0.1	417	FALSE = Not active TRUE = Active (Motor potentiometer reference DECREASES until the contact is opened)
P3.3.4.3	Motor potentiometer ramp time	0.1	500.0	Hz/s	10.0	331	Rate of change in the motor potentiometer reference when increased or decreased with parameters P3.3.4.1 or P3.3.4.2.
P3.3.4.4	Motor potentiometer reset	0	2		1	367	Motor potentiometer frequency reference reset logic. 0 = No reset 1 = Reset if stopped 2 = Reset if powered down

Flushing parameters

Table 22. Flushing parameters

Index	Parameter	Min	Max	Unit	Default	ID	Description
P3.3.6.1	Activate flushing reference				DigIN Slot0.1	530	Connect to digital input to activate par. P3.3.6.2. NOTE! The drive will start if the input is activated!
P3.3.6.2	Flushing reference	-MaxRef	MaxRef	Hz	0.00*	1239	Defines the frequency reference when flushing reference is activated (P3.3.6.1).

* Default value when using Standard Application. See the values for the other applications in Appendix 1.

4.4 GROUP 3.4: RAMPS AND BRAKES SETUP

4.4.1 RAMP 1 SETUP

Table 23. Ramp 1 setup

Index	Parameter	Min	Max	Unit	Default	ID	Description
P3.4.1.1	Ramp 1 shape	0.0	100.0	%	0.0	500	The start and the end of acceleration and deceleration ramps can be smoothed with this parameter.
P3.4.1.2	Acceleration time 1	0.1	3000.0	s	5.0	103	Defines the time required for the output frequency to increase from zero frequency to maximum frequency
P3.4.1.3	Deceleration time 1	0.1	3000.0	s	5.0	104	Defines the time required for the output frequency to decrease from maximum frequency to zero frequency

4.4.2 RAMP 2 SETUP

Table 24. Ramp 2 setup

Index	Parameter	Min	Max	Unit	Default	ID	Description
P3.4.2.1	Ramp 2 shape	0.0	100.0	%	0.0	501	The start and the end of acceleration and deceleration ramps can be smoothed with this parameter.
P3.4.2.2	Acceleration time 2	0.1	300.0	s	10.0	502	Defines the time required for the output frequency to increase from zero frequency to maximum frequency
P3.4.2.3	Deceleration time 2	0.1	300.0	s	10.0	503	Defines the time required for the output frequency to decrease from maximum frequency to zero frequency
P3.4.2.4	Ramp 2 selection	Varies	Varies		DigIN Slot0.1	408	Used for switching between ramps 1 and 2. FALSE = Ramp 1 shape, acceleration time 1 and deceleration time 1. TRUE = Ramp 2 shape, acceleration time 2 and Deceleration time 2.
P3.4.2.5	Ramp 2 threshold frequency	0.0	P3.3.1.2	Hz	0.0	533	Defines the frequency, above which the second ramp times and shapes are used. 0= Not used

4.4.3 START MAGNETISATION PARAMETERS*Table 25. Start magnetisation parameters*

Index	Parameter	Min	Max	Unit	Default	ID	Description
P3.4.3.1	Start magnetising current	0.00	IL	A	IH	517	Defines the DC current fed into motor at start. Disabled if set to 0.
P3.4.3.2	Start magnetising time	0,00	600,00	s	0,00	516	This parameter defines the time for how long DC current is fed to motor before acceleration starts.

4.4.4 DC BRAKE PARAMETERS*Table 26. DC-brake parameters*

Index	Parameter	Min	Max	Unit	Default	ID	Description
P3.4.4.1	DC brake current	0	IL	A	IH	507	Defines the current injected into the motor during DC-braking. 0 = Disabled
P3.4.4.2	DC braking time at stop	0,00	600,00	s	0,00	508	Determines if braking is ON or OFF and the braking time of the DC-brake when the motor is stopping.
P3.4.4.3	Frequency to start DC braking at ramp stop	0,10	10,00	Hz	1,50	515	The output frequency at which the DC-braking is applied.

4.4.5 FLUX BRAKING PARAMETERS*Table 27. Flux braking parameters*

Index	Parameter	Min	Max	Unit	Default	ID	Description
P3.4.5.1	Flux braking	0	1		0	520	0=Disabled 1=Enabled
P3.4.5.2	Flux braking current	0	IL	A	IH	519	Defines the current level for flux braking.

4.5 GROUP 3.5: I/O CONFIGURATION

4.5.1 DIGITAL INPUT SETTINGS

Table 28. Digital input settings

Index	Parameter	Default	ID	Description
P3.5.1.1	Control signal 1 A	DigIN SlotA.1*	403	Ctrl signal 1 when control place is I/O A (FWD)
P3.5.1.2	Control signal 2 A	DigIN SlotA.2*	404	Ctrl signal 2 when control place is I/O A (REV)
P3.5.1.3	Control signal 3 A	DigIN Slot0.1	434	Ctrl signal 3 when control place is I/O A
P3.5.1.4	Control signal 1 B	DigIN Slot0.1	423	Start signal 1 when control place is I/O B
P3.5.1.5	Control signal 2 B	DigIN Slot0.1	424	Start signal 2 when control place is I/O B
P3.5.1.6	Control signal 3 B	DigIN Slot0.1	435	Start signal 3 when control place is I/O B
P3.5.1.7	I/O B control force	DigIN Slot0.1*	425	CLOSED = Force the control place to I/O B
P3.5.1.8	I/O B reference force	DigIN Slot0.1*	343	CLOSED = Used frequency reference is specified by I/O reference B parameter (P3.3.1.6).
P3.5.1.9	Fieldbus control force	DigIN Slot0.1*	411	Force control to fieldbus
P3.5.1.10	Keypad control force	DigIN Slot0.1*	410	Force control to keypad
P3.5.1.11	External fault close	DigIN SlotA.3*	405	OPEN = OK CLOSED = External fault
P3.5.1.12	External fault open	DigIN Slot0.2	406	OPEN = External fault CLOSED = OK
P3.5.1.13	Fault reset close	DigIN SlotA.6*	414	Resets all active faults when CLOSED
P3.5.1.14	Fault reset open	DigIN Slot0.1	213	Resets all active faults when OPEN
P3.5.1.15	Run enable	DigIN Slot0.2	407	Must be on to set drive in Ready state
P3.5.1.16	Run interlock 1	DigIN Slot0.2	1041	Drive may be ready but start is blocked as long as interlock is on (Damper interlock).
P3.5.1.17	Run interlock 2	DigIN Slot0.2	1042	As above.
P3.5.1.18	Motor preheat ON	DigIN Slot0.1	1044	OPEN = No action CLOSED = Uses the motor preheat DC-Current in Stop state. Used when parameter P3.18.1 is set to 2.
P3.5.1.19	Ramp 2 selection	DigIN Slot0.1	408	Used for switching between ramps 1 and 2. OPEN = Ramp 1 shape, acceleration time 1 and deceleration time 1. CLOSED = Ramp 2 shape, acceleration time 2 and Deceleration time 2.
P3.5.1.20	Acc/Dec prohibit	DigIN Slot0.1	415	No acceleration or deceleration possible until the contact is opened.
P3.5.1.21	Preset frequency selection 0	DigIN SlotA.4*	419	Binary selector for Preset speeds (0-7).
P3.5.1.22	Preset frequency selection 1	DigIN SlotA.5*	420	Binary selector for Preset speeds (0-7).
P3.5.1.23	Preset frequency selection 2	DigIN Slot0.1*	421	Binary selector for Preset speeds (0-7).
P3.5.1.24	Motor potentiometer UP	DigIN Slot0.1	418	OPEN = Not active CLOSED = Active (Motor potentiometer reference INCREASES until the contact is opened)
P3.5.1.25	Motor potentiometer DOWN	DigIN Slot0.1	417	OPEN = Not active CLOSED = Active (Motor potentiometer reference DECREASES until the contact is opened)

Table 28. Digital input settings

Index	Parameter	Default	ID	Description
P3.5.1.26	Quick stop activation	DigIN Slot0.2	1213	OPEN = Activated. See parameter group Quick Stop in order to configure these functions.
P3.5.1.27	Timer 1	DigIN Slot0.1	447	Rising edge starts Timer 1 programmed in Group 3.12: timer functions parameter group
P3.5.1.28	Timer 2	DigIN Slot0.1	448	See above
P3.5.1.29	Timer 3	DigIN Slot0.1	449	See above
P3.5.1.30	PID1 setpoint boost	DigIN Slot0.1	1046	OPEN = No boost CLOSED = Boost
P3.5.1.31	PID1 select setpoint	DigIN Slot0.1*	1047	OPEN = Setpoint 1 CLOSED = Setpoint 2
P3.5.1.32	External PID start signal	DigIN Slot0.2	1049	OPEN = PID2 in stop mode CLOSED = PID2 regulating This parameter will have no effect if the external PID-controller is not enabled in Group 3.14: external PID controller.
P3.5.1.33	External PID select setpoint	DigIN Slot0.1	1048	OPEN = Setpoint 1 CLOSED = Setpoint 2
P3.5.1.34	Reset maintenance counter 1	DigIN Slot0.1	490	CLOSED = Reset
P3.5.1.36	Flushing reference activation	DigIN Slot0.1*	530	Connect to digital input to activate par. P3.3.6.2. NOTE! The drive will start if the input is activated!
P3.5.1.38	Fire mode activation OPEN	DigIN Slot0.2	1596	Activates the Fire Mode if enabled by correct password. OPEN = Fire Mode active CLOSED = No action
P3.5.1.39	Fire mode activation CLOSE	DigIN Slot0.1	1619	Activates the Fire Mode if enabled by correct password. OPEN = No action CLOSED = Fire Mode active
P3.5.1.40	Fire mode reverse	DigIN Slot0.1	1618	Reverse command of rotation direction while running in Fire Mode. This function has no effect in normal operation. OPEN = Forward CLOSED = Reverse
P3.5.1.41	Auto-cleaning activation	DigIN Slot0.1	1715	Start the Auto-cleaning sequence. The sequence will be aborted if activation signal is removed before the sequence has been completed. NOTE! The drive will start if the input is activated!
P3.5.1.42	Pump 1 interlock	DigIN Slot0.1*	426	OPEN = Not active CLOSED = Active
P3.5.1.43	Pump 2 interlock	DigIN Slot0.1*	427	OPEN = Not active CLOSED = Active
P3.5.1.44	Pump 3 interlock	DigIN Slot0.1*	428	OPEN = Not active CLOSED = Active
P3.5.1.45	Pump 4 interlock	DigIN Slot0.1	429	OPEN = Not active CLOSED = Active
P3.5.1.46	Pump 5 interlock	DigIN Slot0.1	430	OPEN = Not active CLOSED = Active

Table 28. Digital input settings

Index	Parameter	Default	ID	Description
P3.5.1.47	Pump 6 interlock	DigIN Slot0.1	486	OPEN = Not active CLOSED = Active
P3.5.1.48	Pump 7 interlock	DigIN Slot0.1	487	OPEN = Not active CLOSED = Active
P3.5.1.49	Pump 8 interlock	DigIN Slot0.1	488	OPEN = Not active CLOSED = Active
P3.5.1.52	Reset kWh trip counter	DigIN Slot0.1	1053	Resets the kWh trip counter

* The default values above are valid when using Standard Application. See the values for the other applications in Appendix 1.

4.5.2 ANALOGUE INPUTS

NOTE! The number of usable analogue inputs depends on your (option) board setup. The standard I/O board embodies 2 analogue inputs.

Analogue input 1

Table 29. Analogue input 1 settings

Index	Parameter	Min	Max	Unit	Default	ID	Description
P3.5.2.1.1	AI1 signal selection				AnIN SlotA.1	377	Connect the AI1 signal to the analogue input of your choice with this parameter. Programmable. See ch. 8.5.1
P3.5.2.1.2	AI1 signal filter time	0.00	300.00	s	0.1	378	Filter time for analogue input.
P3.5.2.1.3	AI1 signal range	0	1		0	379	0 = 0...10V / 0...20mA 1 = 2...10V / 4...20mA
P3.5.2.1.4	AI1 custom. min	-160.00	160.00	%	0.00	380	Custom range min setting 20% = 4-20 mA/2-10 V
P3.5.2.1.5	AI1 custom. max	-160.00	160.00	%	100.00	381	Custom range max setting
P3.5.2.1.6	AI1 signal inversion	0	1		0	387	0 = Normal 1 = Signal inverted

Analogue input 2

Table 30. Analogue input 2 settings

Index	Parameter	Min	Max	Unit	Default	ID	Description
P3.5.2.2.1	AI2 signal selection				AnIN SlotA.2	388	See P3.5.2.1.1.
P3.5.2.2.2	AI2 signal filter time	0.00	300.00	s	0.1	389	See P3.5.2.1.2.
P3.5.2.2.3	AI2 signal range	0	1		1	390	See P3.5.2.1.3.
P3.5.2.2.4	AI2 custom. min	-160.00	160.00	%	0.00	391	See P3.5.2.1.4.
P3.5.2.2.5	AI2 custom. max	-160.00	160.00	%	100.00	392	See P3.5.2.1.5.
P3.5.2.2.6	AI2 signal inversion	0	1		0	398	See P3.5.2.1.6.

Analogue input 3*Table 31. Analogue input 3 settings*

Index	Parameter	Min	Max	Unit	Default	ID	Description
P3.5.2.3.1	AI3 signal selection				AnIN SlotD.1	141	See P3.5.2.1.1.
P3.5.2.3.2	AI3 signal filter time	0.00	300.00	s	0.1	142	See P3.5.2.1.2.
P3.5.2.3.3	AI3 signal range	0	1		0	143	See P3.5.2.1.3.
P3.5.2.3.4	AI3 custom. min	-160.00	160.00	%	0.00	144	See P3.5.2.1.4.
P3.5.2.3.5	AI3 custom. max	-160.00	160.00	%	100.00	145	See P3.5.2.1.5.
P3.5.2.3.6	AI3 signal inversion	0	1		0	151	See P3.5.2.1.6.

Analogue input 4*Table 32. Analogue input 4 settings*

Index	Parameter	Min	Max	Unit	Default	ID	Description
P3.5.2.4.1	AI4 signal selection				AnIN SlotD.2	152	See P3.5.2.1.1.
P3.5.2.4.2	AI4 signal filter time	0.00	300.00	s	0.1	153	See P3.5.2.1.2.
P3.5.2.4.3	AI4 signal range	0	1		0	154	See P3.5.2.1.3.
P3.5.2.4.4	AI4 custom. min	-160.00	160.00	%	0.00	155	See P3.5.2.1.4.
P3.5.2.4.5	AI4 custom. max	-160.00	160.00	%	100.00	156	See P3.5.2.1.5.
P3.5.2.4.6	AI4 signal inversion	0	1		0	162	See P3.5.2.1.6.

Analogue input 5*Table 33. Analogue input 5 settings*

Index	Parameter	Min	Max	Unit	Default	ID	Description
P3.5.2.5.1	AI5 signal selection				AnIN SlotE.1	188	See P3.5.2.1.1.
P3.5.2.5.2	AI5 signal filter time	0.00	300.00	s	0.1	189	See P3.5.2.1.2.
P3.5.2.5.3	AI5 signal range	0	1		0	190	See P3.5.2.1.3.
P3.5.2.5.4	AI5 custom. min	-160.00	160.00	%	0.00	191	See P3.5.2.1.4.
P3.5.2.5.5	AI5 custom. max	-160.00	160.00	%	100.00	192	See P3.5.2.1.5.
P3.5.2.5.6	AI5 signal inversion	0	1		0	198	See P3.5.2.1.6.

Analogue input 6*Table 34. Analogue input 6 settings*

Index	Parameter	Min	Max	Unit	Default	ID	Description
P3.5.2.6.1	AI6 signal selection				AnIN SlotE.2	199	See P3.5.2.1.1.
P3.5.2.6.2	AI6 signal filter time	0.00	300.00	s	0.1	200	See P3.5.2.1.2.
P3.5.2.6.3	AI6 signal range	0	1		0	201	See P3.5.2.1.3.
P3.5.2.6.4	AI6 custom. min	-160.00	160.00	%	0.00	202	See P3.5.2.1.4.
P3.5.2.6.5	AI6 custom. max	-160.00	160.00	%	100.00	203	See P3.5.2.1.5.
P3.5.2.6.6	AI6 signal inversion	0	1		0	209	See P3.5.2.1.6.

4.5.3 DIGITAL OUTPUTS, SLOT B (STANDARD)

Table 35. Digital output settings on standard I/O board

Index	Parameter	Min	Max	Unit	Default	ID	Description
P3.5.3.2.1	Basic R01 function	0	56		2*	11001	Function sel. for Basic R01: 0 = None 1 = Ready 2 = Run 3 = General fault 4 = General fault inverted 5 = General alarm 6 = Reversed 7 = At speed 8 = Thermistor fault 9 = Motor regulator active 10 = Start signal active 11 = Keypad control active 12 = I/O B control activated 13 = Limit supervision 1 14 = Limit supervision 2 15 = Fire Mode active 16 = Flushing activated 17 = Preset freq. active 18 = Quick stop activated 19 = PID in Sleep mode 20 = PID soft fill active 21 = PID supervision limits 22 = Ext. PID superv. limits 23 = Input press. alarm/fault 24 = Frost prot. alarm/fault 25 = Time channel 1 26 = Time channel 2 27 = Time channel 3 28 = FB ControlWord B13 29 = FB ControlWord B14 30 = FB ControlWord B15 31 = FB ProcessData1.B0 32 = FB ProcessData1.B1 33 = FB ProcessData1.B2 34 = Maintenance alarm 35 = Maintenance fault 36 = Block 1 Out 37 = Block 2 Out 38 = Block 3 Out 39 = Block 4 Out 40 = Block 5 Out 41 = Block 6 Out 42 = Block 7 Out 43 = Block 8 Out 44 = Block 9 Out 45 = Block 10 Out 46 = Jockey pump control 47 = Priming pump control 48 = Auto-cleaning active 49 = Multipump K1 control 50 = Multipump K2 control 51 = Multipump K3 control 52 = Multipump K4 control 53 = Multipump K5 control 54 = Multipump K6 control 55 = Multipump K7 control 56 = Multipump K8 control
M3.5.3.2.2	Basic R01 ON delay	0.00	320.00	s	0.00	11002	ON delay for relay
M3.5.3.2.3	Basic R01 OFF delay	0.00	320.00	s	0.00	11003	OFF delay for relay
M3.5.3.2.4	Basic R02 function	0	56		3*	11004	See P3.5.3.2.1.
M3.5.3.2.5	Basic R02 ON delay	0.00	320.00	s	0.00	11005	See M3.5.3.2.2.
M3.5.3.2.6	Basic R02 OFF delay	0.00	320.00	s	0.00	11006	See M3.5.3.2.3.
M3.5.3.2.7	Basic R03 function	0	56		1*	11007	See P3.5.3.2.1. Not visible if only 2 output relays are installed

* Default value when using Standard Application. See the values for the other applications in Appendix 1

4.5.4 EXPANDER SLOTS C, D AND E DIGITAL OUTPUTS

Shows only parameters for existing outputs on option boards placed in slots C, D and E. Selections as in Standard R01 (P3.5.3.2.1).

This group or these parameters are not visible if no digital outputs exist in slots C, D or E.

4.5.5 ANALOGUE OUTPUTS, SLOT A (STANDARD)

Table 36. Standard I/O board analogue output settings

Index	Parameter	Min	Max	Unit	Default	ID	Description
P3.5.4.1.1	A01 function	0	31		2	10050	0=TEST 0% (Not used) 1=TEST 100% 2=Output freq (0 -fmax) 3=Freq reference (0-fmax) 4=Motor speed (0 - Motor nominal speed) 5=Output current (0-I _{nMotor}) 6=Motor torque (0-T _{nMotor}) 7=Motor power (0-P _{nMotor}) 8=Motor voltage (0-U _{nMotor}) 9=DC link voltage (0-1000V) 10=PID Setpoint (0-100%) 11=PID Feedback (0-100%) 12=PID1 output (0-100%) 13=Ext.PID output (0-100%) 14=ProcessDataIn1 (0-100%) 15=ProcessDataIn2 (0-100%) 16=ProcessDataIn3 (0-100%) 17=ProcessDataIn4 (0-100%) 18=ProcessDataIn5 (0-100%) 19=ProcessDataIn6 (0-100%) 20=ProcessDataIn7 (0-100%) 21=ProcessDataIn8 (0-100%) 22=Block 1 out (0-100%) 23=Block 2 out (0-100%) 24=Block 3 out (0-100%) 25=Block 4 out (0-100%) 26=Block 5 out (0-100%) 27=Block 6 out (0-100%) 28=Block 7 out (0-100%) 29=Block 8 out (0-100%) 30=Block 9 out (0-100%) 31=Block 10 out (0-100%)
P3.5.4.1.2	A01 filter time	0.0	300.0	s	1.0	10051	Filtering time of analogue output signal. See P3.5.2.1.2 0 = No filtering
P3.5.4.1.3	A01 minimum	0	1		0	10052	0 = 0 mA / 0V 1 = 4 mA / 2V Signal type (current/voltage) selected with dip switches. Note the difference in analogue output scaling in parameter P3.5.4.1.4. See also parameter P3.5.2.1.3.
P3.5.4.1.4	A01 minimum scale	Varies	Varies	Varies	0.0	10053	Min scale in process unit (depends on selection of A01 function).
P3.5.4.1.5	A01 maximum scale	Varies	Varies	Varies	0.0	10054	Max scale in process unit (depends on selection of A01 function)

4.5.6 EXPANDER SLOTS D TO E ANALOGUE OUTPUTS

Shows only parameters for existing outputs on option boards placed in slots C, D and E. Selections as in Standard A01 (P3.5.4.1.1).

This group or these parameters are not visible if no digital outputs exist in slots C, D or E.

4.6 GROUP 3.6: FIELDBUS DATA MAPPING

Table 37. Fieldbus data mapping

Index	Parameter	Min	Max	Unit	Default	ID	Description
P3.6.1	Fieldbus data out 1 selection	0	35000		1	852	Data sent to fieldbus can be chosen with parameter and monitor value ID numbers. The data is scaled to unsigned 16-bit format according to the format on keypad. E.g. 25.5 on keypad equals 255.
P3.6.2	Fieldbus data out 2 selection	0	35000		2	853	Select Process Data Out with parameter ID
P3.6.3	Fieldbus data out 3 selection	0	35000		3	854	Select Process Data Out with parameter ID
P3.6.4	Fieldbus data out 4 selection	0	35000		4	855	Select Process Data Out with parameter ID
P3.6.5	Fieldbus data out 5 selection	0	35000		5	856	Select Process Data Out with parameter ID
P3.6.6	Fieldbus data out 6 selection	0	35000		6	857	Select Process Data Out with parameter ID
P3.6.7	Fieldbus data out 7 selection	0	35000		7	858	Select Process Data Out with parameter ID
P3.6.8	Fieldbus data out 8 selection	0	35000		37	859	Select Process Data Out with parameter ID

Fieldbus process data out

Default values for Process Data Out to monitor through fieldbus are listed in Table 38.

Table 38. Fieldbus Process Data Out

Data	Value	Scale
Process Data Out 1	Output frequency	0.01 Hz
Process Data Out 2	Motor speed	1 rpm
Process Data Out 3	Motor current	0.1 A
Process Data Out 4	Motor torque	0.1 %
Process Data Out 5	Motor power	0.1 %
Process Data Out 6	Motor voltage	0.1 V
Process Data Out 7	DC-link voltage	1 V
Process Data Out 8	Last active fault code	1

Example: Value '2500' for *Output Frequency* corresponds to '25.00 Hz' (scaling value is 0.01). All monitoring values listed in Chapter 3.1.12 Fieldbus data monitoring are given the scaling value.

4.7 GROUP 3.7: PROHIBIT FREQUENCIES

Table 39. Prohibit frequencies

Index	Parameter	Min	Max	Unit	Default	ID	Description
P3.7.1	Prohibit frequency range 1 low limit	-1,00	320,00	Hz	0,00	509	0 = Not used
P3.7.2	Prohibit frequency range 1 high limit	0,00	320,00	Hz	0,00	510	0 = Not used
P3.7.3	Prohibit frequency range 2 low limit	0,00	320,00	Hz	0,00	511	0 = Not used
P3.7.4	Prohibit frequency range 2 high limit	0,00	320,00	Hz	0,00	512	0 = Not used
P3.7.5	Prohibit frequency range 3 low limit	0,00	320,00	Hz	0,00	513	0 = Not used
P3.7.6	Prohibit frequency range 3 high limit	0,00	320,00	Hz	0,00	514	0 = Not used
P3.7.7	Ramp time factor	0,1	10,0	Times	1,0	518	Multiplier of the currently selected ramp time between prohibit frequency limits.

4.8 GROUP 3.8: SUPERVISIONS

Choose here:

1. one or two (P3.8.1/P3.8.5) signal values for supervision.
2. whether the low or high limits are supervised (P3.8.2/P3.8.6)
3. the actual limit values (P3.8.3/P3.8.7).
4. the hystereses for the set limit values (P3.8.4/P3.8.8).

Table 40. Supervision settings

Index	Parameter	Min	Max	Unit	Default	ID	Description
P3.8.1	Supervision #1 item selection	0	17		0	1431	0 = Output frequency 1 = Frequency reference 2 = Motor current 3 = Motor torque 4 = Motor power 5 = DC-link voltage 6 = Analogue input 1 7 = Analogue input 2 8 = Analogue input 3 9 = Analogue input 4 10 = Analogue input 5 11 = Analogue input 6 12 = Temperature input 1 13 = Temperature input 2 14 = Temperature input 3 15 = Temperature input 4 16 = Temperature input 5 17 = Temperature input 6
P3.8.2	Supervision #1 mode	0	2		0	1432	0 = Not used 1 = Low limit supervision (output active under limit) 2 = High limit supervision (output active over limit)

Table 40. Supervision settings

P3.8.3	Supervision #1 limit	-50.00	50.00	Varies	25.00	1433	Supervision limit for selected item. Unit appears automatically.
P3.8.4	Supervision #1 limit hysteresis	0.00	50.00	Varies	5.00	1434	Supervision limit hysteresis for selected item. Unit is set automatically.
P3.8.5	Supervision #2 item selection	0	17		1	1435	See P3.8.1.
P3.8.6	Supervision #2 mode	0	2		0	1436	See P3.8.2.
P3.8.7	Supervision #2 limit	-50.00	50.00	Varies	40.00	1437	See P3.8.3.
P3.8.8	Supervision #2 limit hysteresis	0.00	50.00	Varies	5.00	1438	See P3.8.4.

4.9 GROUP 3.9: PROTECTIONS

4.9.1 GENERAL PROTECTIONS SETTINGS

Table 41. General protections settings

Index	Parameter	Min	Max	Unit	Default	ID	Description
P3.9.1.2	Response to external fault	0	3		2	701	0 = No action 1 = Alarm 2 = Fault (Stop according to stop function) 3 = Fault (Stop by coasting)
P3.9.1.3	Response to input phase fault	0	1		0	730	0 = 3-phase support 1 = 1-phase support NOTE! If 1-phase supply is used, 1-phase support must be selected.
P3.9.1.4	Undervoltage fault	0	1		0	727	0 = Fault stored in history 1 = Fault not stored in history
P3.9.1.5	Response to output phase fault	0	3		2	702	See P3.9.1.2.
P3.9.1.6	Response to Fieldbus communication fault	0	5		3	733	0 = No action 1 = Alarm 2 = Alarm + preset fault frequency (P3.9.1.13) 3 = Fault (Stop according to stop function) 4 = Fault (Stop by coasting)
P3.9.1.7	Slot communication fault	0	3		2	734	See P3.9.1.2.
P3.9.1.8	Thermistor fault	0	3		0	732	See P3.9.1.2.
P3.9.1.9	PID Soft Fill fault	0	3		2	748	See P3.9.1.2.
P3.9.1.10	Response to PID1 supervision fault	0	3		2	749	See P3.9.1.2.
P3.9.1.11	Response to external PID supervision fault	0	3		2	757	See P3.9.1.2.
P3.9.1.12	Earth fault	0	3		3	703	See P3.9.1.2. NOTE! This fault can be configured in frames MR7 to MR9 only.
P3.9.1.13	Preset alarm frequency	P3.3.1.1	P3.3.1.2	Hz	25.00	183	This frequency used when fault response (in Group 3.9: protections) is Alarm+preset frequency
P3.9.1.14	STO fault	0	3			775	0 = No action 1 = Alarm 2 = Fault (Stop according to stop function) 3 = Fault (Stop by coasting)

4.9.2 MOTOR THERMAL PROTECTIONS SETTINGS

Table 42. Motor thermal protection settings

Index	Parameter	Min	Max	Unit	Default	ID	Description
P3.9.2.1	Motor thermal protection	0	3		2	704	0 = No action 1 = Alarm 2 = Fault (Stop according to stop mode) 3 = Fault (Stop by coasting) If available, use the motor thermistor to protect the motor. Choose then value 0 for this parameter.
P3.9.2.2	Ambient temperature	-20.0	100.0	°C/F	40.0	705	Ambient temperature in °C/F
P3.9.2.3	Zero speed cooling factor	5.0	150.0	%	Varies	706	Defines the cooling factor at zero speed in relation to the point where the motor is running at nominal speed without external cooling.
P3.9.2.4	Motor thermal time constant	1	200	min	Varies	707	The time constant is the time within which the calculated thermal stage has reached 63% of its final value.
P3.9.2.5	Motor thermal loadability	10	150	%	100	708	

4.9.3 MOTOR STALL PROTECTION SETTINGS

Table 43. Motor stall protection settings

Index	Parameter	Min	Max	Unit	Default	ID	Description
P3.9.3.1	Motor stall fault	0	3		0	709	0 = No action 1 = Alarm 2 = Fault (Stop according to stop mode) 3 = Fault (Stop by coasting)
P3.9.3.2	Stall current	0.00	I_s	A	Varies	710	For a stall stage to occur, the current must have exceeded this limit.
P3.9.3.3	Stall time limit	1.00	120.00	s	15.00	711	This is the maximum time allowed for a stall stage.
P3.9.3.4	Stall frequency limit	1.00	P3.3.1.2	Hz	25.00	712	For a stall state to occur, the output frequency must have remained below this limit for a certain time.

4.9.4 UNDERLOAD (DRY PUMP) PROTECTION SETTINGS

Table 44. Motor underload protection settings

Index	Parameter	Min	Max	Unit	Default	ID	Description
P3.9.4.1	Underload fault	0	3		0	713	0 = No action 1 = Alarm 2 = Fault (Stop according to stop mode) 3 = Fault (Stop by coasting)
P3.9.4.2	Underload protection: Field weakening area load	10.0	150.0	%	50.0	714	This parameter gives the value for the minimum torque allowed when the output frequency is above the field weakening point.
P3.9.4.3	Underload protection: Zero frequency load	5.0	150.0	%	10.0	715	This parameter gives value for the minimum torque allowed with zero frequency. If you change the value of parameter P3.1.1.4 this parameter is automatically restored to the default value.
P3.9.4.4	Underload protection: Time limit	2.00	600.00	s	20.00	716	This is the maximum time allowed for an underload state to exist.

4.9.5 QUICK STOP SETTINGS

Table 45. Quick stop settings

Index	Parameter	Min	Max	Unit	Default	ID	Description
P3.9.5.1	Quick stop mode	0	2		1	1276	Method to stop the drive if the Quick stop function is activated from DI or fieldbus 0 = Coasting 1 = Quick stop (Ramp stop according to P3.9.5.3) 2 = Stop according to Stop function (P3.2.5)
P3.9.5.2	Quick stop activation	Varies	Varies		DigIN Slot0.2	1213	FALSE = Activated
P3.9.5.3	Quick stop deceleration time	0.1	300.0	s	3.0	1256	
P3.9.5.4	Response to Quick stop fault	0	2		1	744	0 = No action 1 = Alarm 2 = Fault (Stop according to Quick stop mode)

4.9.6 TEMPERATURE INPUT FAULT 1 SETTINGS

NOTE! This parameter group is visible only with an option board for temperature measurement (OPTBH) installed.

Table 46. Temperature input fault 1 settings

Index	Parameter	Min	Max	Unit	Default	ID	Description
P3.9.6.1	Temperature signal 1	0	63		0	739	Selection of signals to use for alarm and fault triggering. B0 = Temperature Signal 1 B1 = Temperature Signal 2 B2 = Temperature Signal 3 B3 = Temperature Signal 4 B4 = Temperature Signal 5 B5 = Temperature Signal 6 Max value is taken of the chosen signals and used for alarm/fault triggering. NOTE! Only 6 first temperature inputs are supported (counting boards from slot A to slot E).
P3.9.6.2	Alarm limit 1	-50.0	200.0	°C/F	130.0	741	Temperature limit for triggering alarm. NOTE! Only inputs chosen with parameter P3.9.6.1 are compared.
P3.9.6.3	Fault limit 1	-50.0	200.0	°C/F	155.0	742	Temperature limit for triggering alarm. NOTE! Only inputs chosen with parameter P3.9.6.1 are compared.
P3.9.6.4	Fault limit response 1	0	3		2	740	0 = No response 1 = Alarm 2 = Fault (Stop according to stop mode) 3 = Fault (Stop by coasting)

4.9.7 TEMPERATURE INPUT FAULT 2 SETTINGS

NOTE! This parameter group is visible only with an option board for temperature measurement (OPTBH) installed.

Table 47. Temperature input fault 2 settings

Index	Parameter	Min	Max	Unit	Default	ID	Description
P3.9.6.5	Temperature signal 2	0	63		0	763	Selection of signals to use for alarm and fault triggering. B0 = Temperature Signal 1 B1 = Temperature Signal 2 B2 = Temperature Signal 3 B3 = Temperature Signal 4 B4 = Temperature Signal 5 B5 = Temperature Signal 6 Max value is taken of the chosen signals and used for alarm/fault triggering. NOTE! Only 6 first temperature inputs are supported (counting boards from slot A to slot E).
P3.9.6.6	Alarm limit 2	-30.0	200.0	°C/F	130.0	764	Temperature limit for triggering alarm. NOTE! Only inputs chosen with parameter P3.9.6.5 are compared.
P3.9.6.7	Fault limit 2	-30.0	200.0	°C/F	155.0	765	Temperature limit for triggering alarm. NOTE! Only inputs chosen with parameter P3.9.6.5 are compared.
P3.9.6.8	Fault limit response 2	0	3		2	766	0 = No response 1 = Alarm 2 = Fault (Stop according to stop mode) 3 = Fault (Stop by coasting)

4.9.8 AI LOW PROTECTION

Table 48. AI low protection settings

Index	Parameter	Min	Max	Unit	Default	ID	Description
P3.9.8.1	Analogue input low protection	0	2		2	767	0 = No protection 1 = Protection enabled in Run state 2 = Protection enabled in Run and Stop state
P3.9.8.2	Analogue input low fault	0	5		0	700	0=No action 1=Alarm 2=Alarm + preset fault frequency (par. P3.9.1.13) 3=Alarm + previous frequency reference 4=Fault (Stop according to stop mode) 5=Fault (Stop by coasting)

4.10 GROUP 3.10: AUTOMATIC RESET

Table 49. Autoreset settings

Index	Parameter	Min	Max	Unit	Default	ID	Description
P3.10.1	Automatic reset	0	1		0	731	0 = Disabled 1 = Enabled
P3.10.2	Restart function	0	1		1	719	The start mode for Automatic reset is selected with this parameter: 0 = Flying start 1 = According to par. P3.2.4
P3.10.3	Wait time	0.10	10000.00	s	0.50	717	Wait time before the first reset is executed.
P3.10.4	Trial time	0.00	10000.00	s	60.00	718	When the trial time has elapsed, and the fault is still active, the drive will trip to fault.
P3.10.5	Number of trials	1	10		4	759	NOTE! Total number of trials (irrespective of fault type). If the drive is not able to be reset within this number of trials and the set trial time a fault will be generated.
P3.10.6	Autoreset: Undervoltage	0	1		1	720	Autoreset permitted? 0 = No 1 = Yes
P3.10.7	Autoreset: Overvoltage	0	1		1	721	Autoreset permitted? 0 = No 1 = Yes
P3.10.8	Autoreset: Overcurrent	0	1		1	722	Autoreset permitted? 0 = No 1 = Yes
P3.10.9	Autoreset: AI low	0	1		1	723	Autoreset permitted? 0 = No 1 = Yes
P3.10.10	Autoreset: Unit over-temperature	0	1		1	724	Autoreset permitted? 0 = No 1 = Yes
P3.10.11	Autoreset: Motor over-temperature	0	1		1	725	Autoreset permitted? 0 = No 1 = Yes
P3.10.12	Autoreset: External fault	0	1		0	726	Autoreset permitted? 0 = No 1 = Yes
P3.10.13	Autoreset: Underload fault	0	1		0	738	Autoreset permitted? 0 = No 1 = Yes

4.1.1 GROUP 3.11: APPLICATION SETTINGS

Table 50. Application settings

Index	Parameter	Min	Max	Unit	Default	ID	Description
P3.11.1	Password	0	9999		0	1806	Administrator password
P3.11.2	C/F selection	0	1		0	1197	0 = Celsius 1 = Fahrenheit All temperature-related parameters and monitoring values are presented in the selected unit.
P3.11.3	kW/hp selection	0	1		0	1198	0 = kW 1 = hp All power-related parameters and monitoring values are presented in the selected unit
P3.11.4	Multimonitor view	0	2		1	1196	Division of keypad display into sections in Multimonitor view. 0 = 2x2 sections 1 = 3x2 sections 2 = 3x3 sections

4.12 GROUP 3.12: TIMER FUNCTIONS

Interval 1

Table 51. Timer functions, Interval 1

Index	Parameter	Min	Max	Unit	Default	ID	Description
P3.12.1.1	ON time	00:00:00	23:59:59	hh:mm:ss	00:00:00	1464	ON time
P3.12.1.2	OFF time	00:00:00	23:59:59	hh:mm:ss	00:00:00	1465	OFF time
P3.12.1.3	Days					1466	Days of week when active. Checkbox selection: B0 = Sunday B1 = Monday B2 = Tuesday B3 = Wednesday B4 = Thursday B5 = Friday B6 = Saturday
P3.12.1.4	Assign to channel					1468	Select affected time channel (1-3) Checkbox selection: B0 = Time channel 1 B1 = Time channel 2 B2 = Time channel 3

Interval 2

Table 52. Timer functions, Interval 2

Index	Parameter	Min	Max	Unit	Default	ID	Description
P3.12.2.1	ON time	00:00:00	23:59:59	hh:mm:ss	00:00:00	1469	See P3.12.1.1.
P3.12.2.2	OFF time	00:00:00	23:59:59	hh:mm:ss	00:00:00	1470	See P3.12.1.2.
P3.12.2.3	Days					1471	See P3.12.1.3.
P3.12.2.4	Assign to channel					1473	See P3.12.1.4.

Interval 3

Table 53. Timer functions, Interval 3

Index	Parameter	Min	Max	Unit	Default	ID	Description
P3.12.3.1	ON time	00:00:00	23:59:59	hh:mm:ss	00:00:00	1474	See P3.12.1.1.
P3.12.3.2	OFF time	00:00:00	23:59:59	hh:mm:ss	00:00:00	1475	See P3.12.1.2.
P3.12.3.3	Days					1476	See P3.12.1.3.
P3.12.3.4	Assign to channel					1478	See P3.12.1.4.

Interval 4

Table 54. Timer functions, Interval 4

Index	Parameter	Min	Max	Unit	Default	ID	Description
P3.12.4.1	ON time	00:00:00	23:59:59	hh:mm:ss	00:00:00	1479	See P3.12.1.1.
P3.12.4.2	OFF time	00:00:00	23:59:59	hh:mm:ss	00:00:00	1480	See P3.12.1.2.
P3.12.4.3	Days					1481	See P3.12.1.3.
P3.12.4.4	Assign to channel					1483	See P3.12.1.4.

Interval 5

Table 55. Timer functions, Interval 5

Index	Parameter	Min	Max	Unit	Default	ID	Description
P3.12.5.1	ON time	00:00:00	23:59:59	hh:mm:ss	00:00:00	1484	See P3.12.1.1.
P3.12.5.2	OFF time	00:00:00	23:59:59	hh:mm:ss	00:00:00	1485	See P3.12.1.2.
P3.12.5.3	Days					1486	See P3.12.1.3.
P3.12.5.4	Assign to channel					1488	See P3.12.1.4.

Timer 1

Table 56. Timer functions, Timer 1

Index	Parameter	Min	Max	Unit	Default	ID	Description
P3.12.6.1	Duration	0	72000	s	0	1489	The time the timer will run when activated. [Activated by DI]
P3.12.6.2	Timer 1				DigINSlot 0.1	447	Rising edge starts Timer 1 programmed in Group 3.12: timer functions parameter group.
P3.12.6.3	Assign to channel					1490	Select affected time channel (1-3) Checkbox selection: B0 = Time channel 1 B1 = Time channel 2 B2 = Time channel 3

Timer 2

Table 57. Timer functions, Timer 2

Index	Parameter	Min	Max	Unit	Default	ID	Description
P3.12.7.1	Duration	0	72000	s	0	1491	See P3.12.6.1.
P3.12.7.2	Timer 2				DigINSlot 0.1	448	See P3.12.6.2.
P3.12.7.3	Assign to channel					1492	See P3.12.6.3.

Timer 3

Table 58. Timer functions, Timer 3

Index	Parameter	Min	Max	Unit	Default	ID	Description
P3.12.8.1	Duration	0	72000	s	0	1493	See P3.12.6.1.
P3.12.8.2	Timer 3				DigINSlot 0.1	448	See P3.12.6.2.
P3.12.8.3	Assign to channel					1494	See P3.12.6.3.



4.13 GROUP 3.13: PID CONTROLLER 1**4.13.1 BASIC SETTINGS***Table 59. PID controller 1 basic settings*

Index	Parameter	Min	Max	Unit	Default	ID	Description
P3.13.1.1	PID gain	0.00	1000.00	%	100.00	118	If the value of the parameter is set to 100% a change of 10% in the error value causes the controller output to change by 10%.
P3.13.1.2	PID integration time	0.00	600.00	s	1.00	119	If this parameter is set to 1,00s a change of 10% in the error value causes the controller output to change by 10.00%/s.
P3.13.1.3	PID derivation time	0.00	100.00	s	0.00	132	If this parameter is set to 1,00s a change of 10% in the error value during 1.00 s causes the controller output to change by 10.00%.

Table 59. PID controller 1 basic settings

P3.13.1.4	Process unit selection	1	44		1	1036	Select unit for actual value. 1=% 2=1/min 3=rpm 4=ppm 5=pps 6=l/s 7=l/min 8=l/h 9=kg/s 10=kg/min 11=kg/h 12=m3/s 13=m3/min 14=m3/h 15=m/s 16=mbar 17=bar 18=Pa 19=kPa 20=mVS 21=kW 22=°C 23=gal/s 24=gal/min 25=gal/h 26=lb/s 27=lb/min 28=lb/h 29=ft3/s 30=ft3/min 31=ft3/h 32=ft/s 33=in wg 34=ft wg 35=PSI 36=lb/in2 37=psig 38=hp 39=°F 40=ft 41=inch 42=mm 43=cm 44=m
P3.13.1.5	Process unit min	Varies	Varies	Varies	0	1033	Value in Process units at 0% feedback or setpoint. This scaling is done for monitoring purpose only. The PID controller still uses the percentage internally for feedbacks and setpoints.
P3.13.1.6	Process unit max	Varies	Varies	Varies	100	1034	See above.
P3.13.1.7	Process unit decimals	0	4		2	1035	Number of decimals for process unit value

Table 59. PID controller 1 basic settings

	P3.13.1.8	Error inversion	0	1		0	340	0 = Normal (Feedback < Setpoint -> Increase PID output) 1 = Inverted (Feedback < Setpoint -> Decrease PID output)
	P3.13.1.9	Dead band	Varies	Varies	Varies	0	1056	Dead band area around the setpoint in process units. The PID output is locked if the feedback stays within the deadband area for a predefined time.
	P3.13.1.10	Dead band delay	0.00	320.00	s	0.00	1057	If the feedback stays within the dead band area for a predefined time, the output is locked.

4.13.2 SETPOINTS

Table 60. Setpoints settings

Index	Parameter	Min	Max	Unit	Default	ID	Description
P3.13.2.1	Keypad setpoint 1	Varies	Varies	Varies	0	167	
P3.13.2.2	Keypad setpoint 2	Varies	Varies	Varies	0	168	
P3.13.2.3	Setpoint ramp time	0.00	300.0	s	0.00	1068	Defines the rising and falling ramp times for setpoint changes. (Time to change from minimum to maximum)
P3.13.2.4	PID1 setpoint boost activation	Varies	Varies		DigIN Slot0.1	1046	FALSE = No boost TRUE = Boost
P3.13.2.5	PID1 select setpoint	Varies	Varies		DigIN Slot0.1	1047	FALSE = Setpoint 1 TRUE = Setpoint 2
P3.13.2.6	Setpoint source 1 selection	0	32		3	332	0 = Not used 1 = Keypad setpoint 1 2 = Keypad setpoint 2 3 = AI1 4 = AI2 5 = AI3 6 = AI4 7 = AI5 8 = AI6 9=ProceDataIn1 10=ProceDataIn2 11=ProceDataIn3 12=ProceDataIn4 13=ProceDataIn5 14=ProceDataIn6 15=ProceDataIn7 16=ProceDataIn8 17=Temp.Input 1 18=Temp.Input 2 19=Temp.Input 3 20=Temp.Input 4 21=Temp.Input 5 22=Temp.Input 6 23=Block 1 Out 24=Block 2 Out 25=Block 3 Out 26=Block 4 Out 27=Block 5 Out 28=Block 6 Out 29=Block 7 Out 30=Block 8 Out 31=Block 9 Out AI's and ProcessDataIn are handled as percent (0.00-100.00%) and scaled according to Setpoint minimum and maximum. NOTE! ProcessDataIn signals use 2 decimals.
P3.13.2.7	Setpoint 1 minimum	Varies	Varies	%	0.00	1069	Minimum value at analogue signal minimum.
P3.13.2.8	Setpoint 1 maximum	Varies	Varies	%	100.00	1070	Maximum value at analogue signal maximum.
P3.13.2.9	Setpoint 1 boost	-2.0	2.0	x	1.0	1071	The setpoint can be boosted with a digital input.
P3.13.2.10	Setpoint source 2 selection	0	Varies		2	431	See par. P3.13.2.6.
P3.13.2.11	Setpoint 2 minimum	Varies	Varies	%	0.00	1073	Minimum value at analogue signal minimum.

Table 60. Setpoints settings

P3.13.2.12	Setpoint 2 maximum	Varies	Varies	%	100.00	1074	Maximum value at analogue signal maximum.
P3.13.2.13	Setpoint 2 boost	-2.0	2.0	x	1.0	1078	See P3.13.2.9.

4.13.3 FEEDBACK SETTINGS

Table 61. Feedback settings

Index	Parameter	Min	Max	Unit	Default	ID	Description
P3.13.3.1	Feedback function	1	9		1	333	1=Only Source1 in use 2=SQRT(Source1); (Flow=Constant x SQRT(Pressure)) 3= SQRT(Source1- Source 2) 4= SQRT(Source 1) + SQRT (Source 2) 5= Source 1 + Source 2 6= Source 1 - Source 2 7=MIN (Source 1, Source 2) 8=MAX (Source 1, Source 2) 9=MEAN (Source 1, Source 2)
P3.13.3.2	Feedback function gain	-1000.0	1000.0	%	100.0	1058	Used e.g. with selection 2 in <i>Feedback function</i>
P3.13.3.3	Feedback 1 source selection	0	30		2	334	0 = Not used 1 = AI1 2 = AI2 3 = AI3 4 = AI4 5 = AI5 6 = AI6 7 = ProcessDataIn1 8 = ProcessDataIn2 9 = ProcessDataIn3 10 = ProcessDataIn4 11 = ProcessDataIn5 12 = ProcessDataIn6 13 = ProcessDataIn7 14 = ProcessDataIn8 15 = Temperature input 1 16 = Temperature input 2 17 = Temperature input 3 18 = Temperature input 4 19 = Temperature input 5 20 = Temperature input 6 21 = Block 1 Out 22 = Block 2 Out 23 = Block 3 Out 24 = Block 4 Out 25 = Block 5 Out 26 = Block 6 Out 27 = Block 7 Out 28 = Block 8 Out 29 = Block 9 Out 30 = Block 10 Out AI's and ProcessDataIn are handled as % (0.00-100.00%) and scaled according to Feedback min and max. NOTE! ProcessDataIn use two decimals. NOTE! If temperature inputs are selected, feedback minimum and maximum scaling parameters needs to be set -50..200 C

Table 61. Feedback settings

P3.13.3.4	Feedback 1 minimum	Varies	Varies	%	0.00	336	Minimum value at analogue signal minimum.
P3.13.3.5	Feedback 1 maximum	Varies	Varies	%	100.00	337	Maximum value at analogue signal maximum.
P3.13.3.6	Feedback 2 source selection	0	Varies		0	335	See P3.13.3.3
P3.13.3.7	Feedback 2 minimum	Varies	Varies	%	0.00	338	Minimum value at analogue signal minimum.
M3.13.3.8	Feedback 2 maximum	Varies	Varies	%	100.00	339	Maximum value at analogue signal maximum.

4.13.4 FEEDFORWARD SETTINGS

Table 62. Feedforward settings

Index	Parameter	Min	Max	Unit	Default	ID	Description
P3.13.4.1	Feedforward function	1	9		1	1059	See P3.13.3.1.
P3.13.4.2	Feedforward function gain	-1000	1000	%	100.0	1060	See P3.13.3.2.
P3.13.4.3	Feedforward 1 source selection	0	25		0	1061	See P3.13.3.3.
P3.13.4.4	Feedforward 1 minimum	-200.00	200.00	%	0.00	1062	See P3.13.3.4.
P3.13.4.5	Feedforward 1 maximum	-200.00	200.00	%	100.00	1063	See P3.13.3.5.
P3.13.4.6	Feedforward 2 source selection	0	25		0	1064	See P3.13.3.6.
P3.13.4.7	Feedforward 2 min	-200.00	200.00	%	0.00	1065	See P3.13.3.7.
P3.13.4.8	Feedforward 2 max	-200.00	200.00	%	100.00	1066	See M3.13.3.8.

4.13.5 SLEEP FUNCTION SETTINGS

Table 63. Sleep function settings

Index	Parameter	Min	Max	Unit	Default	ID	Description
P3.13.5.1	SP1 Sleep frequency limit	0.00	320.00	Hz	0.00	1016	Drive goes to sleep mode when the output frequency stays below this limit for a time greater than that defined by parameter Sleep delay, P3.13.5.2.
P3.13.5.2	SP1 Sleep delay	0	3000	s	0	1017	The minimum amount of time the frequency has to remain below P3.13.5.1 before the drive is stopped.
P3.13.5.3	SP1 Wake-up level	Varies	Varies	Varies	0.0000	1018	Defines the level for the PID feedback value wake-up supervision. Uses selected process units.
P3.13.5.4	SP1 Sleep boost	-9999	9999	P3.13.1.4	0	1793	Setpoint 1 boost
P3.13.5.5	SP1 Sleep boost maximum time	1	300	s	30	1795	SP1 sleep boost timeout
P3.13.5.6	SP2 Sleep frequency limit	0.00	320.00	Hz	0.00	1075	See P3.13.5.1.
P3.13.5.7	SP2 Sleep delay	0	3000	s	0	1076	See P3.13.5.2.
P3.13.5.8	SP2 Wake-up level	Varies	Varies	Varies	0.0	1077	See P3.13.5.3.
P3.13.5.9	SP2 Sleep boost	-9999	9999	P3.13.1.4	0	1794	See P3.13.5.4.
P3.13.5.10	SP2 Sleep boost maximum time	1	300	s	30	1796	See P3.13.5.5.

4.13.6 FEEDBACK SUPERVISION PARAMETERS

Table 64. Feedback supervision parameters

Index	Parameter	Min	Max	Unit	Default	ID	Description
P3.13.6.1	Enable feedback supervision	0	1		0	735	0 = Disabled 1 = Enabled
P3.13.6.2	Upper limit	Varies	Varies	Varies	Varies	736	Upper feedback/process value supervision
P3.13.6.3	Lower limit	Varies	Varies	Varies	Varies	758	Lower feedback/process value supervision
P3.13.6.4	Delay	0	30000	s	0	737	If the desired value is not reached within this time a fault or alarm is created.
P3.13.6.5	Response to PID1 supervision fault	0	3		2	749	0 = No action 1 = Alarm 2 = Fault (Stop according to P3.2.5) 3 = Fault (Stop by coasting)





4.13.7 PRESSURE LOSS COMPENSATION PARAMETERS

Table 65. Pressure loss compensation parameters

Index	Parameter	Min	Max	Unit	Default	ID	Description
P3.13.7.1	Enable compensation for setpoint 1	0	1		0	1189	Enables pressure loss compensation for setpoint 1. 0 = Disabled 1 = Enabled
P3.13.7.2	Setpoint 1 max compensation	Varies	Varies	Varies	0.0	1190	Value added proportionally to the frequency. Setpoint compensation = Max compensation * (FreqOut - MinFreq)/(MaxFreq - MinFreq)
P3.13.7.3	Enable compensation for setpoint 2	0	1		0	1191	See P3.13.7.1.
P3.13.7.4	Setpoint 2 max compensation	Varies	Varies	Varies	0.0	1192	See P3.13.7.2.

4.13.8 SOFT FILL SETTINGS

Table 66. Soft fill settings

Index	Parameter	Min	Max	Unit	Default	ID	Description
 P3.13.8.1	Soft fill function	0	2		0	1094	0 = Disabled 1 = Enabled, Level 2 = Enabled, Timeout
 P3.13.8.2	Soft fill frequency	0.00	P3.3.1.2	Hz	20.00	1055	Frequency reference to be used when Soft Fill function is active.
 P3.13.8.3	Soft fill level	Varies	Varies	Varies	0.0000	1095	The drive runs at soft fill frequency (P3.13.8.2) until the PID feedback reaches this value. At this point the PID controller starts to regulate. NOTE! This parameter is used only if P3.13.8.1 = 1 Enabled (Level) is selected.
 P3.13.8.4	Soft fill timeout	0	30000	s	0	1096	If P3.13.8.1 = 1 Enabled (Level): If the desired soft fill level is not reached within this time, a fault or alarm is generated. 0=No timeout, no fault triggering If P3.13.8.1 = 2 Enabled (Timeout): The drive runs at soft fill frequency (P3.13.8.2) until the time defined by this parameter has elapsed. After this the PID controller starts to regulate.
P3.13.8.5	PID Soft Fill timeout response	0	3		2	738	0 = No action 1 = Alarm 2 = Fault (Stop according to stop mode) 3 = Fault (Stop by coasting) NOTE! This parameter is used only if P3.13.8.1 = 1 Enabled (Level)

4.13.9 INPUT PRESSURE SUPERVISION

Table 67. Input pressure supervision parameters

Index	Parameter	Min	Max	Unit	Default	ID	Description
P3.13.9.1	Enable supervision	0	1		0	1685	0 = Disabled 1 = Enabled Enables the Input Pressure Supervision.
P3.13.9.2	Supervision signal	0	23		0	1686	The source of input pressure measurement signal: 0=Analogue input 1 1=Analogue input 2 2=Analogue input 3 3=Analogue input 4 4=Analogue input 5 5=Analogue input 6 6=ProcessDataIn1 (0-100%) 7=ProcessDataIn2 (0-100%) 8=ProcessDataIn3 (0-100%) 9=ProcessDataIn4 (0-100%) 10=ProcessDataIn5 (0-100%) 11=ProcessDataIn6 (0-100%) 12=ProcessDataIn7 (0-100%) 13=ProcessDataIn8 (0-100%) 14 = Block 1 Out 15 = Block 2 Out 16 = Block 3 Out 17 = Block 4 Out 18 = Block 5 Out 19 = Block 6 Out 20 = Block 7 Out 21 = Block 8 Out 22 = Block 9 Out 23 = Block 10 Out
P3.13.9.3	Supervision unit selection	1	9	Varies	3	1687	1=% 2=mbar 3=bar 4=Pa 5=kPa 6=PSI 7=mmHg 8=Torr 9=lb/in2
P3.13.9.4	Supervision unit decimals	0	4		2	1688	Choose how many decimals to show.
P3.13.9.5	Supervision unit minimum value	Varies	Varies	P3.13.9.3	0.00	1689	Unit min and max parameters are the signal values corresponding to e.g. 4mA and 20mA respectively (scaled linearly between these).
P3.13.9.6	Supervision unit maximum value	Varies	Varies	P3.13.9.3	10.00	1690	
P3.13.9.7	Supervision alarm level	Varies	Varies	P3.13.9.3	0.50	1691	Alarm (Fault ID 1363) will be launched if supervision signal stays below the alarm level longer than the time defined by parameter P3.13.9.9.

Table 67. Input pressure supervision parameters

Index	Parameter	Min	Max	Unit	Default	ID	Description
P3.13.9.8	Supervision fault level	Varies	Varies	P3.13.9.3	0.10	1692	Fault (Fault ID 1409) will be launched if supervision signal stays below the fault level longer than the time defined by parameter P3.13.9.9.
P3.13.9.9	Supervision fault delay	0.00	60.00	s	5.00	1693	Delay time to launch the <i>Input pressure supervision alarm</i> or <i>fault</i> , if the supervision signal stays below the alarm/fault level longer than defined by this parameter.
P3.13.9.10	PID setpoint reduction	0.0	100.0	%	10.0	1694	Defines the rate of the PID controller setpoint reduction when the Input pressure supervision alarm is active.
V3.13.9.11	Input pressure	P3.13.9.5	P3.13.9.6	P3.13.9.3	Varies	1695	Monitoring value for selected Input pressure supervision signal. Scaling value according to P3.13.9.4.



4.13.10 SLEEP - NO DEMAND DETECTION

Table 68. Sleep - no demand detection parameters

Index	Parameter	Min	Max	Unit	Default	ID	Description
P3.13.10.1	Sleep no demand detection enable	0	1		0	1649	Enables Sleep No Demand Detection (SNDD) function. 0 = Disabled 1 = Enabled
P3.13.10.2	SNDD error hysteresis	0	99999.9	P3.13.1.4	0.5	1658	Semi-amplitude of symmetrical process error band for no demand detection (0±hysteresis)
P3.13.10.3	SNDD frequency hysteresis	1.00	P3.3.1.2	Hz	3.00	1663	Frequency hysteresis for no demand detection
P3.13.10.4	SNDD supervision time	0	600	s	120	1668	Supervision time for no demand detection
P3.13.10.5	SNDD actual add	0.1	P3.13.10.2	P3.13.1.4	0.5	1669	Bias added to actual PID setpoint value to decrease PID output and reach sleep.

4.14 GROUP 3.14: EXTERNAL PID CONTROLLER

4.14.1 BASIC SETTINGS FOR EXTERNAL PID CONTROLLER

For more detailed information, see chapter 4.13.

Table 69. Basic settings for external PID-controller

Index	Parameter	Min	Max	Unit	Default	ID	Description
P3.14.1.1	Enable external PID	0	1		0	1630	0 = Disabled 1 = Enabled
P3.14.1.2	Start signal				DigIN Slot0.2	1049	FALSE=External PID stopped TRUE=External PID regulating This parameter will have no effect if External PID controller is not enabled by P3.14.1.1.
P3.14.1.3	Output in Stop	0.0	100.0	%	0.0	1100	The output value of the PID controller in % of its maximum output value while it is stopped from digital input
P3.14.1.4	PID gain	0.00	1000.00	%	100.00	1631	See P3.13.1.1.
P3.14.1.5	PID integration time	0.00	600.00	s	1.00	1632	See P3.13.1.2.
P3.14.1.6	PID derivation time	0.00	100.00	s	0.00	1633	See P3.13.1.3.
P3.14.1.7	Process unit selection	0	44		0	1635	See P3.13.1.4.
P3.14.1.8	Process unit min	Varies	Varies	Varies	0	1664	See P3.13.1.5.
P3.14.1.9	Process unit max	Varies	Varies	Varies	100	1665	See P3.13.4.6.
P3.14.1.10	Process unit decimals	0	4		2	1666	
P3.14.1.11	Error inversion	0	1		0	1636	See P3.13.18.
P3.14.1.12	Dead band	Varies	Varies	Varies	0.0	1637	See P3.13.1.9.
P3.14.1.13	Dead band delay	0.00	320.00	s	0.00	1638	See P3.13.1.10.

4.14.2 EXTERNAL PID CONTROLLER, SETPOINTS

Table 70. External PID-controller, setpoints

Index	Parameter	Min	Max	Unit	Default	ID	Description
P3.14.2.1	Keypad setpoint 1	P3.14.1.8	P3.14.1.8	Varies	0.00	1640	
P3.14.2.2	Keypad setpoint 2	P3.14.1.8	P3.14.1.9	Varies	0.00	1641	
P3.14.2.3	Setpoint ramp time	0.00	300.00	s	0.00	1642	
P3.14.2.4	Select setpoint				DigIN Slot0.1	1048	FALSE = Setpoint 1 TRUE = Setpoint 2
P3.14.2.5	Setpoint source 1 selection	0	32		1	1643	0 = Not Used 1 = Keypad Setpoint 1 2 = Keypad Setpoint 2 3 = AI1 4 = AI2 5 = AI3 6 = AI4 7 = AI5 8 = AI6 9 = ProcessDataIn1 10 = ProcessDataIn2 11 = ProcessDataIn3 12 = ProcessDataIn4 13 = ProcessDataIn5 14 = ProcessDataIn6 15 = ProcessDataIn7 16 = ProcessDataIn8 17 = Temperature Input 1 18 = Temperature Input 2 19 = Temperature Input 3 20 = Temperature Input 4 21 = Temperature Input 5 22 = Temperature Input 6 23 = Block 1 Out 24 = Block 2 Out 25 = Block 3 Out 26 = Block 4 Out 27 = Block 5 Out 28 = Block 6 Out 29 = Block 7 Out 30 = Block 8 Out 31 = Block 9 Out 32 = Block 10 Out AI's and ProcessDataIn are handled as percent (0.00-100.00%) and scaled according to Setpoint minimum and maximum. NOTE! ProcessDataIn signals use 2 decimals. NOTE! If temperature inputs are selected, setpoint minimum and maximum scaling parameters need to be set -50..200 C
P3.14.2.6	Setpoint 1 minimum	Varies	Varies	%	0.00	1644	Minimum value at analogue signal minimum.
P3.14.2.7	Setpoint 1 maximum	Varies	Varies	%	100.00	1645	Maximum value at analogue signal maximum.
P3.14.2.8	Setpoint source 2 selection	0	32		0	1646	See P3.14.2.5.
P3.14.2.9	Setpoint 2 minimum	Varies	Varies	%	0.00	1647	Minimum value at analogue signal minimum.

Table 70. External PID-controller, setpoints

P3.14.2.10	Setpoint 2 maximum	Varies	Varies	%	100.00	1648	Maximum value at analogue signal maximum.
------------	--------------------	--------	--------	---	--------	------	---

4.14.3 FEEDBACKS

For more detailed information, see chapter 4.13.

Table 71. External PID-controller, feedbacks

Index	Parameter	Min	Max	Unit	Default	ID	Description
P3.14.3.1	Feedback function	1	9		1	1650	See P3.13.3.1.
P3.14.3.2	Feedback function gain	-1000.0	1000.0	%	100.0	1651	See P3.13.3.2.
P3.14.3.3	Feedback 1 source selection	0	30		1	1652	See P3.13.3.3.
P3.14.3.4	Feedback 1 minimum	Varies	Varies	%	0.00	1653	Minimum value at analogue signal minimum.
P3.14.3.5	Feedback 1 maximum	Varies	Varies	%	100.00	1654	Maximum value at analogue signal maximum.
P3.14.3.6	Feedback 2 source selection	0	30		2	1655	See P3.13.3.6.
P3.14.3.7	Feedback 2 minimum	Varies	Varies	%	0.00	1656	Minimum value at analogue signal minimum.
P3.14.3.8	Feedback 2 maximum	Varies	Varies	%	100.00	1657	Maximum value at analogue signal maximum.

4.14.4 FEEDBACK SUPERVISION

For more detailed information, see chapter 4.13.

Table 72. External PID-controller, process supervision

Index	Parameter	Min	Max	Unit	Default	ID	Description
P3.14.4.1	Enable supervision	0	1		0	1659	0 = Disabled 1 = Enabled
P3.14.4.2	Upper limit	Varies	Varies	Varies	Varies	1660	See P3.13.6.2.
P3.14.4.3	Lower limit	Varies	Varies	Varies	Varies	1661	See P3.13.6.3.
P3.14.4.4	Delay	0	30000	s	0	1662	If the desired value is not reached within this time a fault or alarm is activated.
P3.14.4.5	Response to external PID feedback supervision fault	0	3		2	757	See P3.9.1.2.

4.15 GROUP 3.15: MULTIPUMP

4.15.1 MULTIPUMP PARAMETERS

Table 73. Multipump parameters

Index	Parameter	Min	Max	Unit	Default	ID	Description
P3.15.1	Multipump mode	0	2		0*	1785	0 = Single Drive 1 = Multifollower 2 = Multimaster
P3.15.2	Number of pumps	1	8		1*	1001	Total number of motors (pumps/fans) used in multi-pump system.
P3.15.3	Pump ID number	0	10		0	1500	Each drive in the pump system has to have a unique order (ID) number always starting from 1. NOTE! This parameter is used only if Multi-Follower or Multi-Master mode is selected by P3.15.1.
P3.15.4	Drive operation mode	0	1		0	1782	0 = Auxiliary drive 1 = Leading drive
P3.15.5	Pump interlocking	0	1		1	1032	Enable/Disable use of interlocks. Interlocks are used to tell the system if a motor is connected or not. 0 = Disabled 1 = Enabled
P3.15.6	Autochange mode	0	2		1	1027	Disable/enable rotation of starting order and priority of motors. 0 = Disabled 1 = Enabled (interval) 2 = Enabled (weekdays)
P3.15.7	Autochanged pumps	0	1		1	1028	0 = Auxiliary pumps 1 = All pumps
P3.15.8	Autochange interval	0.0	3000.0	h	48.0	1029	After the expiry of the time defined with this parameter, the autochange function takes place if the capacity used lies below the level defined with parameters P3.15.11 and P3.15.12.
P3.15.9	Autochange days	0	127		0	1786	Weekdays, when starting order is rearranged (autochanged). NOTE! This parameter is used only if P3.15.6=2 and RTC battery is installed. Lisätään: B0=Sunday B1=Monday B2=Tuesday B3=Wednesday B4=Thursday B5=Friday B6=Saturday

Table 73. Multipump parameters

Index	Parameter	Min	Max	Unit	Default	ID	Description
P3.15.10	Autochange: time of day	00:00:00	23:59:59	Time	00:00:00	1787	Time of day when starting order is rearranged (autochanged). NOTE! This parameter is used only if P3.15.6=2 and RTC battery is installed.
P3.15.11	Autochange: Frequency limit	0.00	P3.3.1.2	Hz	25.00*	1031	These parameters define the level below which the capacity used must remain so that the autochange can take place.
P3.15.12	Autochange: Pump limit	1	8		1*	1030	
P3.15.13	Bandwidth	0	100	%	10	1097	Percentage of the setpoint. E.g.: Setpoint = 5 bar, Bandwidth = 10%: As long as the feedback value stays within 4.5...5.5 bar motor disconnection or removal will not take place.
P3.15.14	Bandwidth delay	0	3600	s	10	1098	With feedback outside the bandwidth, this time must pass before pumps are added or removed.
P3.15.15	Constant production speed	0.0	100.0	%	100.0	1513	Pump nominal producing speed as percentual value of MinFreq...MaxFreq. Defines the constant speed at which the pump is locked after the maximum frequency is reached and next pump start to regulate in Multimaster mode.
M3.15.17	Interlock signals	See chapter 4.15.2 below.					
M3.15.18	Overpressure supervision	See chapter 4.15.3 below.					
M3.15.19	Pump running time	See chapter 4.15.4 below.					

* See the default values for the different applications in Appendix 1

4.15.2 INTERLOCK SIGNALS

Table 74. Interlock signals

Index	Parameter	Min	Max	Unit	Default	ID	Description
P3.15.17.1	Pump (1) interlock	Varies	Varies		DigIN Slot0.1	426	FALSE = Not active TRUE = Active
P3.15.17.2	Pump 2 interlock	Varies	Varies		DigIN Slot0.1	427	FALSE = Not active TRUE = Active
P3.15.17.3	Pump 3 interlock	Varies	Varies		DigIN Slot0.1	428	FALSE = Not active TRUE = Active
P3.15.17.4	Pump 4 interlock	Varies	Varies		DigIN Slot0.1	429	FALSE = Not active TRUE = Active
P3.15.17.5	Pump 5 interlock	Varies	Varies		DigIN Slot0.1	430	FALSE = Not active TRUE = Active

Table 74. Interlock signals

P3.15.17.6	Pump 6 interlock	Varies	Varies		DigIN Slot0.1	486	FALSE = Not active TRUE = Active
P3.15.17.7	Pump 7 interlock	Varies	Varies		DigIN Slot0.1	487	FALSE = Not active TRUE = Active
P3.15.17.8	Pump 8 interlock	Varies	Varies		DigIN Slot0.1	488	FALSE = Not active TRUE = Active

4.15.3 OVERPRESSURE SUPERVISION PARAMETERS

Table 75. Overpressure supervision parameters

Index	Parameter	Min	Max	Unit	Default	ID	Description
P3.15.16.1	Enable overpressure supervision	0	1		0	1698	0 = Disabled 1 = Enabled
P3.15.16.2	Supervision alarm level	Varies	Varies	Varies	0.00	1699	This function stops all auxiliary pumps immediately when PID feedback reaches this level.

4.15.4 PUMP RUNNING TIME COUNTERS

Table 76. Pump running time counter parameters

Index	Parameter	Min	Max	Unit	Default	ID	Description
P3.15.19.1	Set Runtime counter	0	1		0	1673	0 = No Action 1 = Set defined counter value (P3.15.19.2) to selected pump run time counter
P3.15.19.2	Set Runtime Counter: Value	0	300 000	h	0	1087	Value to be set to the run time counter of the pump(s) selected with P3.15.19.3
P3.15.19.3	Set Runtime Counter: Pump Selection	0	8		1	1088	Select the pump whose run-time counter value will be set to value defined with P3.15.19.2
P3.15.19.4	Pump Runtime Alarm Limit	0	300 000	h	0	1109	An alarm will be triggered when pump runtime exceeds this limit. 0 = Not Used
P3.15.19.5	Pump Runtime Fault Limit	0	300 000	h	0	1110	A fault will be triggered when pump runtime exceeds this limit. 0 = Not Used



4.16 GROUP 3.16: MAINTENANCE COUNTERS

Table 77. Maintenance counter parameters

Index	Parameter	Min	Max	Unit	Default	ID	Description
P3.16.1	Counter 1 mode	0	2		0	1104	0 = Not used 1 = Hours 2 = Revolutions*1000
P3.16.2	Counter 1 alarm limit	0	Varies	h/kRev	0	1105	When to trig a maintenance alarm for counter 1. 0 = Not used
P3.16.3	Counter 1 fault limit	0	Varies	h/kRev	0	1106	When to trig a maintenance fault for counter 1. 0 = Not used
B3.16.4	Counter 1 reset	0	1		0	1107	Activate to reset maintenance counter 1.
P3.16.5	Counter 1 DI reset	Varies	Varies		0	490	TRUE = Reset

4.17 GROUP 3.17: FIRE MODE

Table 78. Fire mode parameters

Index	Parameter	Min	Max	Unit	Default	ID	Description
P3.17.1	Fire Mode password	0	9999		0	1599	1002 = Enabled 1234 = Test mode
P3.17.2	Fire Mode frequency source	0	18		0	1617	Selection of reference source when Fire Mode is active. This enables selection of e.g. AI1 or PID controller as reference source also while operating in Fire Mode. 0 = Fire Mode frequency 1 = Preset speeds 2 = Keypad 3 = Fieldbus 4 = AI1 5 = AI2 6 = AI1 + AI2 7 = PID1 8 = Motor potentiometer 9 = Block 1 Out 10 = Block 2 Out 11 = Block 3 Out 12 = Block 4 Out 13 = Block 5 Out 14 = Block 6 Out 15 = Block 7 Out 16 = Block 8 Out 17 = Block 9 Out 18 = Block 10 Out
P3.17.3	Fire Mode frequency	0.00	P3.3.1.2	Hz	50.00	1598	Frequency used when Fire Mode is activated.
P3.17.4	Fire Mode activation on OPEN				DigIN Slot0.2	1596	FALSE = Fire Mode active TRUE = No action
P3.17.5	Fire Mode activation on CLOSE				DigIN Slot0.1	1619	FALSE = No action TRUE = Fire Mode active
P3.17.6	Fire Mode reverse				DigIN Slot0.1	1618	Reverse command of rotation direction while running in Fire Mode. This function has no effect in normal operation. DigIN Slot0.1 = Forward DigIN Slot0.2 = Reverse
V3.17.7	Fire Mode status	0	3		0	1597	Monitoring value (see also Table 3) 0=Disabled 1=Enabled 2=Activated (Enabled + DI Open) 3=Test Mode Scaling value: 1
V3.17.8	Fire Mode counter					1679	Shows how many times the Fire mode has been activated in Enabled mode. This counter cannot be reset. Scaling value: 1

4.18 GROUP 3.18: MOTOR PREHEAT PARAMETERS

Table 79. Motor preheat parameters

Index	Parameter	Min	Max	Unit	Default	ID	Description
P3.18.1	Motor preheat function	0	4		0	1225	0 = Not used 1 = Always in stop state 2 = Controlled by DI 3 = Temperature limit 4 = Temperature limit (Measured motor temperature) NOTE! Function 4 requires temperature measurement option board to be installed.
P3.18.2	Preheat temperature limit	-20	100	°C/F	0	1226	Motor preheat switches on when the heatsink temperature or measured motor temperature goes below this level, provided that P3.18.1 is set to selections 3 or 4.
P3.18.3	Motor preheat current	0	0.5*I _L	A	Varies	1227	DC current for pre-heating of motor and drive in stop state. Activated according to P3.18.1.
P3.18.4	Motor preheat ON	Varies	Varies		DigIN Slot0.1	1044	FALSE = No action TRUE = Preheat activated in stop state Used when parameter P3.18.1 is set to 2. NOTE! Also <i>Time channels</i> can be connected to Preheat ON, provided that DIN Control (selection 2 for parameter P3.18.1) is used.

4.1.9 GROUP 3.21: PUMP CONTROL

4.1.9.1 AUTO-CLEANING PARAMETERS

Table 80. Auto-cleaning parameters

Index	Parameter	Min	Max	Unit	Default	ID	Description
P3.21.1.1	Cleaning function	0	3		0	1714	0=Disabled 1=Enabled (DIN) 2=Enabled (current) 3=Enabled (weekdays)
P3.21.1.2	Cleaning activation				DigIN Slot0.1	1715	Digital input signal used to start the Auto Cleaning sequence. Auto-cleaning sequence will be aborted if activation signal is removed before the sequence has been completed. NOTE! The drive will start if the input is activated!
P3.21.1.3	Cleaning current limit	0.0	200.0	%	120.0	1712	If P3.12.1.1 = 2, cleaning sequence starts when motor current exceeds this limit for longer time than P3.21.1.4.
P3.21.1.4	Cleaning current delay	0.0	300.0	%	60.0	1713	If P3.12.1.1 = 2, cleaning sequence starts when motor current exceeds this limit (3.21.1.3) for longer than this delay.
P3.21.1.5	Cleaning weekdays				0	1723	If P3.12.1.1=3, this parameter defines the weekdays when the cleaning cycle will be executed.
P3.21.1.6	Cleaning time of day	00:00:00	23:59:59		00:00:00	1700	If P3.12.1.1=3, this parameter defines the time of day (days selected by P3.21.1.5) when the cleaning cycle will be executed.
P3.21.1.7	Cleaning cycles	1	100		5	1716	Number of forward/reverse cleaning cycles.
P3.21.1.8	Clean forward frequency	0.00	P3.3.1.2	Hz	45.00	1717	Forward direction frequency in Auto-cleaning cycle.
P3.21.1.9	Clean forward time	0.00	320.00	s	2.00	1718	Running time for forward direction frequency in Auto-cleaning cycle.
P3.21.1.10	Clean reverse frequency	0.00	P3.3.1.2	Hz	45.00	1719	Reverse direction frequency in Auto-cleaning cycle.
P3.21.1.11	Clean reverse time	0.00	320.00	s	0.00	1720	Running time for reverse direction frequency in Autocleaning cycle
P3.21.1.12	Cleaning acceleration time	0.1	300.0	s	0.1	1721	Motor acceleration time when Auto-cleaning is active
P3.21.1.13	Cleaning deceleration time	0.1	300.0	s	0.1	1722	Motor deceleration time when Auto-cleaning is active

4.19.2 JOCKEY PUMP PARAMETERS

Table 81. Jockey pump parameters

Index	Parameter	Min	Max	Unit	Default	ID	Description
P3.21.2.1	Jockey function	0	2		0	1674	0 = Not used 1 = PID sleep: Jockey pump runs continuously when PID sleep is active 2 = PID sleep (level): Jockey pump starts at predefined levels when PID sleep is active
P3.21.2.2	Jockey start level	Varies	Varies	Varies	0.00	1675	Jockey pump will start when PID Sleep is active and PID feedback signal goes below the level defined by this parameter. NOTE! This parameter is used only if P3.21.2.1 = 2 (PID Sleep(Level))
P3.21.2.3	Jockey stop level	Varies	Varies	Varies	0.00	1676	Jockey pump will stop when PID Sleep is active and PID feedback signal exceeds the level defined by this parameter or PID-controller wakes from sleep. NOTE! This parameter is used only if P3.21.2.1 = 2 PID Sleep(Level)

4.19.3 PRIMING PUMP PARAMETERS

Table 82. Priming pump parameters



Index	Parameter	Min	Max	Unit	Default	ID	Description
P3.21.3.1	Priming function	0	1		0	1677	0=Disabled 1=Enabled
P3.21.3.2	Priming time	0.0	320.0	s	3.0	1678	Defines the time to start the priming pump before the main pump is started.

4.19.4 ANTI-BLOCKING PARAMETERS

Table 83. Anti-blocking parameters

Index	Parameter	Min	Max	Unit	Default	ID	Description
P3.21.4.1	Anti-blocking Interval	0	960	h	0	1696	Defines interval time in PID sleep mode, after which the pump is started in order to prevent the pump from getting blocked if the pump remains in sleep mode for long time.

Table 83. Anti-blocking parameters

	P3.21.4.2	Anti-blocking runtime	0	300	s	20	1697	Defines the time for how long the pump is kept running when the anti-blocking function is activated.
	P3.21.4.3	Anti-blocking frequency	P3.3.1.1	P3.3.1.2	Hz	15.0	1504	Defines the frequency reference, which is used when the anti-blocking function is activated.

4.19.5 FROST PROTECTION PARAMETERS

Table 84. Frost protection parameters

Index	Parameter	Min	Max	Unit	Default	ID	Description
P3.21.5.1	Frost protection	0	1		0	1704	0 = Disabled 1 = Enabled
P3.21.5.2	Temperature signal	0	29		6	1705	0=Temperature Input 1 (-50..200 C) 1=Temperature Input 2 (-50..200 C) 2=Temperature Input 3 (-50..200 C) 3=Temperature Input 4 (-50..200 C) 4=Temperature Input 5 (-50..200 C) 5=Temperature Input 6 (-50..200 C) 6=Analogue input 1 7=Analogue input 2 8=Analogue input 3 9=Analogue input 4 10=Analogue input 5 11=Analogue input 6 12=ProcessDataIn1 (0-100%) 13=ProcessDataIn2 (0-100%) 14=ProcessDataIn3 (0-100%) 15=ProcessDataIn4 (0-100%) 16=ProcessDataIn5 (0-100%) 17=ProcessDataIn6 (0-100%) 18=ProcessDataIn7 (0-100%) 19=ProcessDataIn8 (0-100%) 20 = Block 1 Out 21 = Block 2 Out 22 = Block 3 Out 23 = Block 4 Out 24 = Block 5 Out 25 = Block 6 Out 26 = Block 7 Out 27 = Block 8 Out 28 = Block 9 Out 29 = Block 10 Out
P3.21.5.3	Temperature signal minimum	-50.0 (°C)	P3.21.5.4	°C/°F	-50.0 (°C)	1706	Temperature value corresponding to minimum value of selected temperature signal.
P3.21.5.4	Temperature signal maximum	P3.21.5.3	200.0 (°C)	°C/°F	200.0 (°C)	1707	Temperature value corresponding to maximum value of selected temperature signal.
P3.21.5.5	Frost Protection Temperature limit	P3.21.5.3	P3.21.5.4	°C/°F	5.00 (°C)	1708	Temperature limit below which the Frost Protection function will be activated.
P3.21.5.6	Frost Protection Frequency	0.0	P3.3.1.2	Hz	10.0	1710	Constant frequency reference which is used when the Frost Protection function is activated

Table 84. Frost protection parameters

V3.21.5.7	Frost temperature monitoring	Varies	Varies	°C/°F		1711	Monitoring value for measured temperature signal in Frost Protection function. Scaling value: 0.1
-----------	------------------------------	--------	--------	-------	--	------	---

5. DIAGNOSTICS MENU

5.1 ACTIVE FAULTS

Table 85.

Menu	Function	Description
Active faults	When a fault/faults appear(s), the display with the name of the fault starts to blink. Press OK to return to the Diagnostics menu. The <i>Active faults</i> submenu shows the number of faults. Select the fault and push OK to see the fault-time data.	The fault remains active until it is cleared with the Reset button (push for 2 s) or with a reset signal from the I/O terminal or fieldbus or by choosing <i>Reset faults</i> (see below). The memory of active faults can store the maximum of 10 faults in the order of appearance.

5.2 RESET FAULTS

Table 86.

Menu	Function	Description
Reset faults	In this menu you can reset faults. For closer instructions, see chapter 9.1 Fault appears.	



CAUTION! Remove external Control signal before resetting the fault to prevent unintentional restart of the drive.

5.3 FAULT HISTORY

Table 87.

Menu	Function	Description
Fault history	40 latest faults are stored in the Fault history.	Entering the Fault history and clicking OK on the selected fault shows the fault time data (details).

5.4 TOTAL COUNTERS

Table 88. Diagnostics menu, Total counters parameters

Index	Parameter	Min	Max	Unit	Default	ID	Description
V4.4.1	Energy counter			Varies		2291	Amount of energy taken from supply network. No reset. NOTE FOR TEXT KEYPAD: The highest energy unit shown on the standard keypad is <i>MW</i> . Should the counted energy exceed 999.9 MW, no unit is shown on the keypad. NOTE! Default value depends on the selected application with parameter 1.2
V4.4.3	Operating time (graphical keypad)			a d hh:min		2298	Control unit operating time NOTE! Default value depends on the selected application with parameter 1.2
V4.4.4	Operating time (text keypad)			a			Control unit operating time in total years NOTE! Default value depends on the selected application with parameter 1.2
V4.4.5	Operating time (text keypad)			d			Control unit operating time in total days NOTE! Default value depends on the selected application with parameter 1.2
V4.4.6	Operating time (text keypad)			hh:min:ss			Control unit operating time in hours, minutes and seconds NOTE! Default value depends on the selected application with parameter 1.2
V4.4.7	Run time (graphical keypad)			a d hh:min		2293	Motor running time NOTE! Default value depends on the selected application with parameter 1.2
V4.4.8	Run time (text keypad)			a			Motor running time in total years NOTE! Default value depends on the selected application with parameter 1.2
V4.4.9	Run time (text keypad)			d			Motor running time in total days NOTE! Default value depends on the selected application with parameter 1.2
V4.4.10	Run time (text keypad)			hh:min:ss			Motor running time in hours, minutes and seconds NOTE! Default value depends on the selected application with parameter 1.2

Table 88. Diagnostics menu, Total counters parameters

V4.4.11	Power on time (graphical keypad)			a d hh:min		2294	Amount of time the power unit has been powered so far. No reset. NOTE! Default value depends on the selected application with parameter 1.2
V4.4.12	Power on time (text keypad)			a			Power on time in total years. NOTE! Default value depends on the selected application with parameter 1.2
V4.4.13	Power on time (text keypad)			d			Power on time in total days NOTE! Default value depends on the selected application with parameter 1.2
V4.4.14	Power on time (text keypad)			hh:min:ss			Power on time in hours, minutes and seconds NOTE! Default value depends on the selected application with parameter 1.2
V4.4.15	Start command counter					2295	The number of times the power unit has been started.

See further information on the counters in chapter 8.11.6 Pump running time counters.

5.5 TRIP COUNTERS

Table 89. Diagnostics menu, Trip counters parameters

Index	Parameter	Min	Max	Unit	Default	ID	Description
P4.5.1	Energy trip counter			Varies		2296	Resettable energy counter. NOTE! The highest energy unit shown on the standard keypad is <i>MW</i> . Should the counted energy exceed 999.9 MW, no unit is shown on the keypad. To reset the counter: <u>Standard text keypad:</u> Apply a long (4 s) push on the OK button. <u>Graphical keypad:</u> Push OK once. <i>Reset counter</i> page will appear. Push OK once again. NOTE! Default value depends on the selected application with parameter 1.2
P4.5.3	Operating time (graphical keypad)			a d hh:min		2299	Resettable. See P4.5.1. NOTE! Default value depends on the selected application with parameter 1.2
P4.5.4	Operating time (text keypad)			a			Operating time in total years NOTE! Default value depends on the selected application with parameter 1.2
P4.5.5	Operating time (text keypad)			d			Operating time in total days NOTE! Default value depends on the selected application with parameter 1.2
P4.5.6	Operating time (text keypad)			hh:min:ss			Operating time in hours, minutes and seconds NOTE! Default value depends on the selected application with parameter 1.2

5.6 SOFTWARE INFO

Table 90. Diagnostics menu, Software info parameters

Index	Parameter	Min	Max	Unit	Default	ID	Description
V4.6.1	Software package (graphical keypad)						Code for software identification
V4.6.2	Software package ID (text keypad)						
V4.6.3	Software package version (text keypad)						
V4.6.4	System load	0	100	%		2300	Load on control unit CPU.
V4.6.5	Application name (graphical keypad)						Name of application.
V4.6.6	Application ID						Application code.
V4.6.7	Application version						

6. I/O AND HARDWARE MENU

6.1 BASIC I/O

Monitor here the statuses of inputs and outputs.

Table 91. I/O and Hardware menu, Basic I/O parameters

Index	Parameter	Min	Max	Unit	Default	ID	Description
V5.1.1	Digital input 1	0	1		0		Status of digital input signal
V5.1.2	Digital input 2	0	1		0		Status of digital input signal
V5.1.3	Digital input 3	0	1		0		Status of digital input signal
V5.1.4	Digital input 4	0	1		0		Status of digital input signal
V5.1.5	Digital input 5	0	1		0		Status of digital input signal
V5.1.6	Digital input 6	0	1		0		Status of digital input signal
V5.1.7	Analogue input 1 mode	1	3		3		Shows the selected (with jumper) mode for Analogue input signal 1 = 0...20mA 3 = 0...10V
V5.1.8	Analogue input 1	0	100	%	0.00		Status of analogue input signal
V5.1.9	Analogue input 2 mode	1	3		3		Shows the selected (with jumper) mode for Analogue input signal 1 = 0...20mA 3 = 0...10V
V5.1.10	Analogue input 2	0	100	%	0.00		Status of analogue input signal
V5.1.11	Analogue output 1 mode	1	3		1		Shows the selected (with jumper) mode for Analogue output signal 1 = 0...20mA 3 = 0...10V
V5.1.12	Analogue output 1	0	100	%	0.00		Status of analogue output signal
V5.1.13	Relay output 1	0	1		0		Status of relay output signal
V5.1.14	Relay output 2	0	1		0		Status of relay output signal
V5.1.15	Relay output 3	0	1		0		Status of relay output signal

6.2 OPTION BOARD SLOTS

The parameters of this group depend on the option board installed. If no option board is placed in slots C, D or E, no parameters are visible. See chapter 8.5.1 Programming of digital and analogue inputs for the location of the slots.

As an option board is removed, info text 39 *Device removed* will appear on the display. See Table 133.

Table 92. Option board-related parameters

Menu	Function	Description
Slot C	Settings	Option board related settings.
	Monitoring	Monitor option board-related info.
Slot D	Settings	Option board related settings.
	Monitoring	Monitor option board-related info.
Slot E	Settings	Option board related settings.
	Monitoring	Monitor option board-related info.

6.3 REAL TIME CLOCK

Table 93. I/O and Hardware menu, Real time clock parameters

Index	Parameter	Min	Max	Unit	Default	ID	Description
V5.5.1	Battery state	1	3		2	2205	Status of battery. 1 = Not installed 2 = Installed 3 = Change battery
P5.5.2	Time			hh:mm:ss		2201	Current time of day
P5.5.3	Date			dd.mm.		2202	Current date
P5.5.4	Year			yyyy		2203	Current year
P5.5.5	Daylight saving	1	4		1	2204	Daylight saving rule 1 = Off 2 = EU; Starts on last Sunday in March, ends last Sunday in October 3 = US; Start on 2nd Sunday in March, ends on 1st Sunday in November 4 = Russia (permanent)

6.4 POWER UNIT SETTINGS

Fan

The fan operates in optimised or always-on mode. In the optimised mode, fan speed is controlled according to the drive's internal logic that receives data from temperature measurements and the fan stops in 5 minutes when the drive is in Ready state. In always-on mode, the fan runs in full speed, without stopping.

Table 94. Power unit settings, Fan

Index	Parameter	Min	Max	Unit	Default	ID	Description
P5.6.1.1	Fan control mode	0	1		1	2377	0 = Always on 1 = Optimised

Sine filter

Sine filter support restricts overmodulation depth and prevents thermal management functions from decreasing switching frequency.

Table 95. Power unit settings, Sine filter

Index	Parameter	Min	Max	Unit	Default	ID	Description
P5.6.4.1	Sine filter	0	1		0		0 = Disabled 1 = Enabled

6.5 KEYPAD

Table 96. I/O and Hardware menu, Keypad parameters

Index	Parameter	Min	Max	Unit	Default	ID	Description
P5.7.1	Timeout time	0	60	min	0		Time after which the display returns to page defined with parameter P5.7.2. 0 = Not used
P5.7.2	Default page	0	4		0		The page the keypad shows when the drive is powered on or when the time defined with P5.7.1 has expired. If the value is set to 0 the page last visited is shown. 0 = None 1 = Enter menu index 2 = Main menu 3 = Control page 4 = Multimonitor
P5.7.3	Menu index						Set menu index for desired page and activate with parameter P5.7.2 = 1.
P5.7.4	Contrast*	30	70	%	50		Set contrast of the display (30...70%).
P5.7.5	Backlight time	0	60	min	5		Set the time until the backlight of the display turns off (0...60 min). If set to 0, backlight is always on.

*Only available with graphical keypad

6.6 FIELDBUS

Parameters related to different fieldbus boards can also be found in the *I/O and Hardware* menu. These parameters are explained in more detail in the respective fieldbus manual.

Table 97.

Submenu level 1	Submenu level 2	Submenu level 3	Submenu level 4	
RS-485	Common settings	Protocol	NA	
Ethernet	Common settings	IP address mode	NA	
		IP address	NA	
		Subnet mask	NA	
		Default gateway	NA	
		MAC address	NA	
	Modbus/TCP	Common settings	Connection limit	
			Slave address	
			Communication timeout	
	BacNet IP	Settings	Instance number	
			Communication timeout	
			Protocol in use	
			BBMD IP	
			BBMD port	
			Time to live	
		Monitoring	FB protocol status	
Communication status				
Actual instance				
Control Word				
		Status Word		

7. USER SETTINGS, FAVOURITES AND USER LEVEL MENUS

7.1 USER SETTINGS

Table 98. User settings menu, General settings

Index	Parameter	Min	Max	Unit	Default	ID	Description
P6.1	Language selections	Varies	Varies		Varies	802	Depends on language package.
P6.2	Application selection					801	Select the application to be used.
M6.5	Parameter backup	See chapter 7.1.1 below.					
M6.6	Parameter compare						
P6.7	Drive name						Give the name of the drive, if needed.

7.1.1 PARAMETER BACKUP

Table 99. User settings menu, Parameter backup parameters

Index	Parameter	Min	Max	Unit	Default	ID	Description
P6.5.1	Restore factory defaults					831	Restores default parameter values and initiates the Startup Wizard when activated
P6.5.2	Save to keypad*	0	1		0		Save parameter values to keypad to e.g. copy them to another drive. 0 = No 1 = Yes
P6.5.3	Restore from keypad*						Load parameter values from keypad to the drive.
B6.5.4	Save to Set 1						Store a customised parameter set (all parameters included in the application)
B6.5.5	Restore from Set 1						Load the customised parameter set to the drive.
B6.5.6	Save to Set 2						Store another customised parameter set (all parameters included in the application)
B6.5.7	Restore from Set 2						Load the customised parameter set 2 to the drive.

*Only available with graphical keypad

7.2 FAVOURITES

NOTE! This menu is not available in the text keypad.

Favourites are typically used to collect a set of parameters or monitoring signals from any of the keypad menus.

You might need to refer to certain parameter values or other items often. Instead of locating them one by one in the menu structure, you may want to add them to a folder called *Favourites* where they can easily be reached.

To add items or parameters to the *Favourites* folder, do the following:

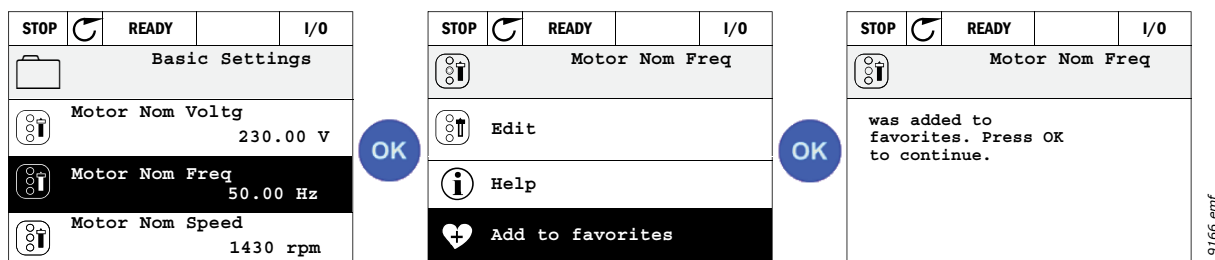

Figure 40. Adding item to Favourites

To remove an item or a parameter from the *Favourites* folder, do the following:

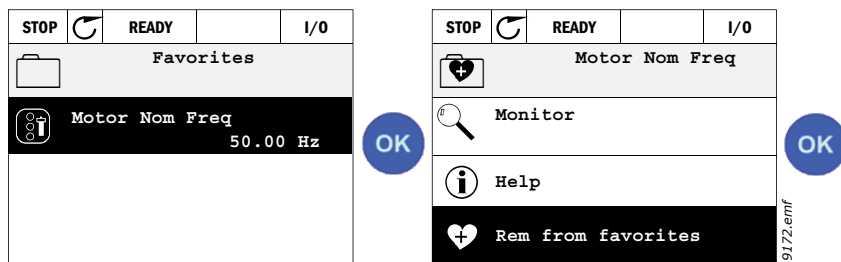

Figure 41. Removing item from Favourites

7.3 USER LEVELS

User level parameters are intended to restrict the visibility of parameters and to prevent unauthorised and inadvertent parameterisation on the keypad.

Table 100. User level parameters

Index	Parameter	Min	Max	Unit	Default	ID	Description
P8.1	User level	1	3		1	1194	1 = Normal; All menus visible in the Main menu 2 = Monitoring; Only Monitor, and User Levels menus are visible in the main menu 3 = Favourites; Only Favourites and User Levels menus are visible in the Main menu

Table 100. User level parameters

P8.2	Access code	0	99999		0	2362	<p>If set to other value than 0 before switching to monitoring when e.g. user level <i>Normal</i> is active, the access code will be asked when trying to switch back to <i>Normal</i>. Can therefore be used to prevent unauthorised parameterisation on the keypad.</p> <p>NOTE! Do not lose the code! If the code is lost, please contact the nearest service center/partner.</p>
------	-------------	---	-------	--	---	------	---

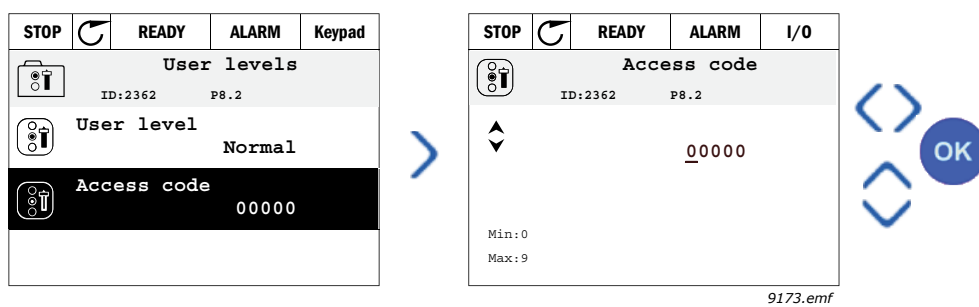

Figure 42.

8. PARAMETER DESCRIPTIONS

Due to its user-friendliness and simplicity of use, most parameters of the drive only require a basic description, which is given in parameter tables in chapter 4 Parameters menu.

In this chapter, you will find additional information on certain most advanced parameters of the drive. If you do not find the information you need, contact your distributor.

P1.2 APPLICATION (ID 212)

When commissioning or starting up the drive, the user can select one of the preset application configurations (the one that corresponds best to the need). Preset application configurations are predefined parameter sets, which will be loaded to the drive when the value of parameter *P1.2 Application* is changed.

The application selection minimises the need for manual editing of the parameters and provides an easy commissioning of the drive.

NOTE! The application wizards are presented in chapter 1.4 Application wizards.

If this parameter is changed by using a (graphical) keypad, selected configuration will be loaded to drive and an application wizard will be started to assist the user by instructing the basic parameters, which are related to the selected application.

The following preset application configurations can be selected:

- 0 = Standard
- 1 = HVAC
- 2 = PID Control
- 3 = Multipump (Single drive)
- 4 = Multipump (Multidrive)

NOTE! Content of the *M1 Quick Setup* menu changes, depending on the selected application.

8.1 MOTOR SETTINGS

P3.1.1.2 MOTOR NOMINAL FREQUENCY (ID 111)

NOTE! When this parameter is changed, parameters P3.1.4.2 Field Weakening Point Frequency and P3.1.4.3 Voltage at Field Weakening Point will be automatically initialised depending on the selected P3.1.2.2 Motor Type. See Table 102.

P3.1.2.2 MOTOR TYPE (ID 650)

This parameter defines the used motor type.

Table 101.

Selection number	Selection name	Description
0	Induction motor (IM)	Select if an induction motor is used.
1	Permanent Magnet Motor (PM)	Select if a permanent magnet motor is used.

When this parameter is changed, parameters P3.1.4.2 and P3.1.4.3 will be automatically initialised according to the selected motor type.

See Table 102 for the initialisation values:

Table 102.

Parameter	Induction Motor (IM)	Permanent Magnet Motor (PM)
P3.1.4.2 (Field weakening point frequency)	Motor nominal frequency	Internally calculated
P3.1.4.3 (Voltage at field weakening point)	100,0%	Internally calculated

P3.1.2.4 IDENTIFICATION (ID 631)

The automatic motor identification calculates or measures the motor parameters that are needed for optimum motor and speed control.

Identification Run is a part of tuning the motor and the drive specific parameters. It is a tool for commissioning and service of the drive with the aim to find as good parameter values as possible for most drives.

NOTE! Motor nameplate parameters have to be set before executing the identification run.

Table 103.

Selection number	Selection name	Description
0	No action	No identification requested.
1	Identification at standstill	The drive is run without speed to identify the motor parameters. The motor is supplied with current and voltage but with zero frequency. U/f ratio is identified.
2	Identification with motor rotating	The drive is run with speed to identify the motor parameters. U/f ratio and magnetisation current are identified. NOTE! This identification run must be performed with no load on the motor shaft for accurate results.

The automatic identification is activated by setting this parameter to the desired value and giving a start command in the requested direction. The start command to the drive has to be given within 20 s. If no start command is given within this time, the identification run is cancelled, the parameter will be reset to its default setting and an *Identification* alarm will be launched.

The identification run can be stopped at any time with normal stop command and the parameter is reset to its default setting. An *Identification* alarm will be launched if the identification run has failed.

NOTE! New start command (Rising edge) is required to start the drive after identification.

P3.1.2.6 MOTOR SWITCH (ID 653)

This function is typically used if there is a switch between the drive and the motor. Such switches are often found in residential and industrial applications to make sure that an electrical circuit can be completely de-energised from the motor for service or maintenance.

When this parameter is enabled and the motor switch is opened to disconnect the running motor, the drive detects the loss of motor without tripping. It is not necessary to make any changes in the run command or the reference signal to the drive from the process control station. When the motor is re-connected after completed maintenance by closing the switch, the drive detects the motor connection and runs the motor to the reference speed as per the process commands.

If the motor is rotating when re-connected, the drive detects the speed of the running motor through its *Flying start* feature and then controls it to desired speed as per the process commands.

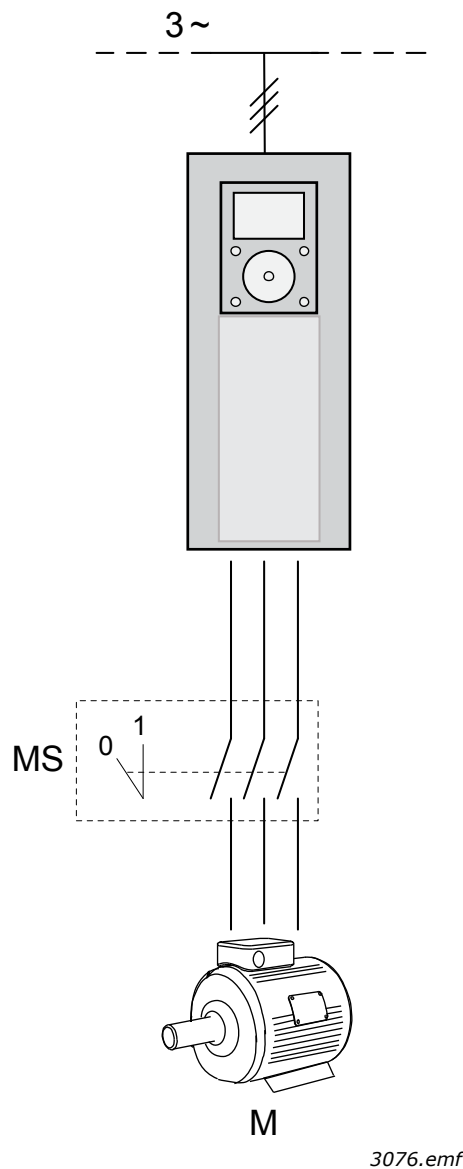

Figure 43. Motor switch

P3.1.2.7 LOAD DROOPING (ID 620)

The drooping function enables speed drop as a function of load. This parameter sets that amount corresponding to the nominal torque of the motor.

This function is used e.g. when balanced load is needed for mechanically connected motors (static drooping) or dynamic speed drooping is needed because of changing load. In static drooping the drooping time is set to equal zero, meaning that the drooping will not decay over time. In dynamic drooping the drooping time is set and the load is momentarily drooped by taking energy from the system inertia instead and which reduces current torque spikes at high instant load changes.

E.g. if load drooping is set to 10% for a motor with a nominal frequency of 50 Hz and the motor is loaded with nominal load (100 % of torque), the output frequency is allowed to decrease 5 Hz from the frequency reference.

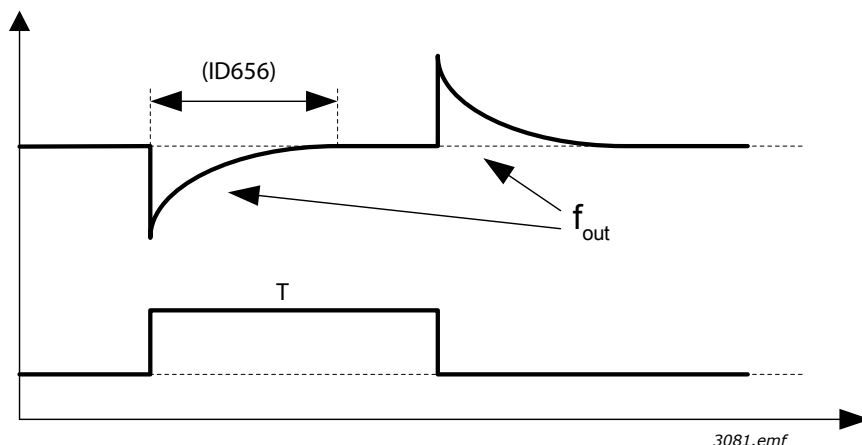

Figure 44. Dynamic load drooping, ID 656 = P3.1.2.8 Load drooping time

P3.1.2.10 OVERVOLTAGE CONTROL (ID 607)

P3.1.2.11 UNDERVOLTAGE CONTROL (ID 608)

These parameters allow the under-/overvoltage controllers to be switched out of operation. This may be useful, for example, if the mains supply voltage varies more than -15% to +10% and the application will not tolerate operation of over-/undervoltage controller. If enabled, the controllers modify the output frequency taking the supply fluctuations into account. P3.1.2.13 Stator voltage adjust.

NOTE! This parameter will be automatically set during the identification run. It is recommended to make the identification run, if possible. See parameter P3.1.2.4.

Stator voltage adjust parameter is used only when *Permanent magnet motor (PM motor)* has been selected for parameter P3.1.2.2. This parameter has no affect if *Induction motor* has been selected. With an induction motor in use, the value has been internally forced to 100% and it cannot be changed.

When the value of parameter P3.1.2.2 (Motor type) parameter is changed to *PMS Motor*, the parameters P3.1.4.2 (Field weakening point frequency) and P3.1.4.3 (Voltage at field weakening point) will be automatically extended up to the limits of the drive's full output voltage, retaining the defined U/f-ratio. This internal extension is done to avoid running the PMS motor in the field weakening area because the PMS motor nominal voltage is typically much lower than the full output voltage capability of the drive.

PMS motor nominal voltage typically represents the motor's back-EMF voltage at nominal frequency, but depending on the motor manufacturer, it may represent e.g. the stator voltage at nominal load.

This parameter gives an easy way to adjust the drive's U/f curve near to the motor's back-EMF curve without needing to change several U/f curve parameters.

The Stator voltage adjust parameter defines the drive's output voltage in percent of the motor's nominal voltage at the motor's nominal frequency.

The U/f curve of the drive is typically tuned slightly above the back-EMF curve of the motor. The motor current increases the more the drive's U/f-curve differs from the motor's back-EMF -curve.

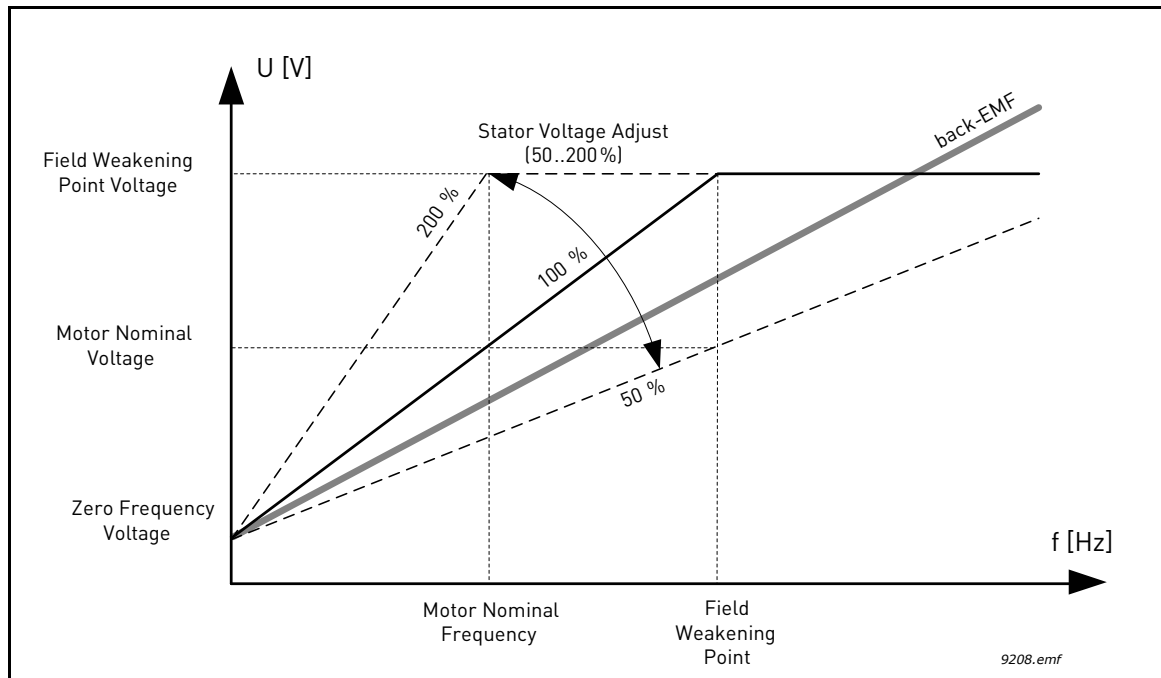

Figure 45. Principle of Stator voltage adjustment

P3.1.3.1 MOTOR CURRENT LIMIT (ID 107)

This parameter determines the maximum motor current from the AC drive. The parameter value range differs from size to size.

When the current limit is active, the drive output frequency is decreased.

NOTE! This is not an overcurrent trip limit.

P3.1.4.1 U/F RATIO (ID 108)

Table 104.

Selection number	Selection name	Description
0	Linear	The voltage of the motor changes linearly as a function of output frequency from zero frequency voltage (P3.1.4.6) to the field weakening point (FWP) voltage (P3.1.4.3) at FWP frequency (P3.1.4.2). This default setting should be used, if there is no special need for another setting.
1	Squared	The voltage of the motor changes from zero Frequency voltage (P3.1.4.6) following a squared curve form from zero to the Field weakening point frequency (P3.1.4.2). See Figure 46. The motor runs undermagnetised below the field weakening point and produces less torque. Squared U/f ratio can be used in applications, where torque demand is proportional to the square of the speed, e.g. in centrifugal fans and pumps.
2	Programmable	The U/f curve can be programmed with three different points (see Figure 47.): Zero frequency voltage (P1), Midpoint voltage/frequency (P2) and Fieldweakening point (P3). Programmable U/f curve can be used if more torque is needed at low frequencies. The optimal settings can automatically be achieved with Motor identification run (P3.1.2.4).

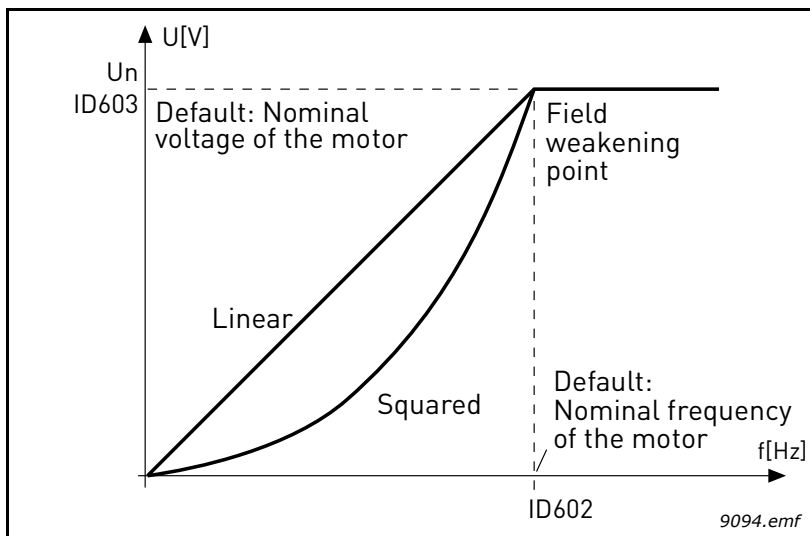

Figure 46. Linear and squared change of motor voltage, ID 602 = P3.1.4.2 Field weakening point, ID 603 = P3.1.4.3 Voltage at field weakening point

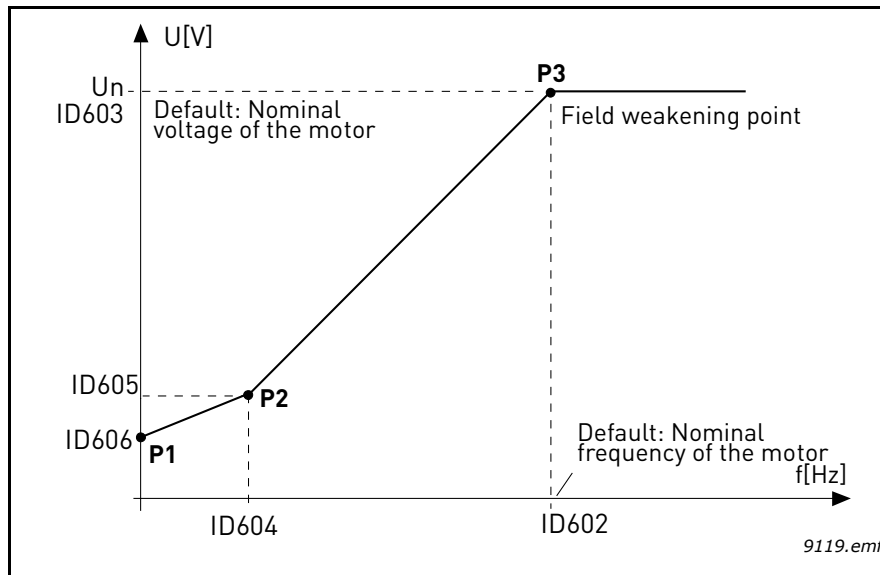

Figure 47. Programmable U/f curve, ID 602 = P3.1.4.2 Field weakening point, ID 603 = P3.1.4.3 Voltage at field weakening point, ID 604 = P3.1.4.4 U/f midpoint frequency, ID 605 = P3.1.4.5 U/f midpoint voltage, ID 606 = P3.1.4.6 Zero frequency voltage

NOTE! This parameter is forced to value '1' *Linear* when parameter *Motor type* is set to value '1' *Permanent Magnet Motor (PM)*.

NOTE! When this parameter is changed, parameters P3.1.4.2 *Field weakening point frequency*, P3.1.4.3 *Voltage at field weakening point*, P3.1.4.4 *U/f midpoint frequency*, P3.1.4.5 *U/f midpoint voltage* and P3.1.4.6 *Zero frequency voltage* will be automatically set to their default values, if parameter P3.1.2.2 *Motor type* is set to '0' *Induction Motor (IM)*.

P3.1.4.3 VOLTAGE AT FIELD WEAKENING POINT (ID 603)

Above the frequency at the field weakening point, the output voltage remains at the set maximum value. Below the frequency at the field weakening point, the output voltage depends on the setting of the U/f curve parameters. See parameters P3.1.4.1, P3.1.4.4 and P3.1.4.5.

When the parameters P3.1.1.1 *Motor nominal voltage* and P3.1.1.2 *Motor nominal frequency* are set, the parameters P3.1.4.2 *Field weakening point frequency* and P3.1.4.3 *Voltage at field weakening point* are automatically given the corresponding values. If you need different values for the field weakening point and the maximum output voltage, change these parameters **after** setting the parameters P3.1.1.1 and P3.1.1.2.

P3.1.4.7 FLYING START (ID 1590)

Flying start can be configured by setting the bits of flying start options parameter. The adjustable bits include disabling of DC pulses and AC scanning, search direction determination and possibility to use frequency reference as a starting point for searching the shaft rotational frequency.

The search direction is determined by B0. When the bit is set to 0, the shaft frequency is searched from both the positive and negative directions. By setting the bit to 1, the search is limited to the frequency reference direction only to avoid any shaft movement for the other direction.

The main goal of AC scanning is to premagnetise the motor. The AC scanning is performed by sweeping frequency from maximum toward zero frequency. The scanning is stopped provided an adaptation to the shaft frequency occurs. The AC scanning can be disabled by setting B1 to 1. When the motor type is selected as permanent magnet motor, the AC scanning is removed automatically.

The bit B5 is for disabling the DC pulses. The main purpose of DC pulses is also to premagnetise and detect rotating motor. If both the DC pulses and AC scanning have been enabled, the applied method is internally chosen depending on the slip frequency. The DC pulses are also internally disabled provided the slip frequency is less than 2Hz or the motor type is selected as permanent magnet motor.

P3.1.4.9 START BOOST (ID 109)

Start boost can be used in situations, where the starting torque is high.

The voltage to the motor changes proportionally to required torque, which makes the motor produce more torque at start.

8.1.1 I/F START FUNCTION

The *I/f Start* function is typically used with permanent magnet motors (PM) to start the motor with constant current control. This is useful with high power motors, in which the resistance is low and the tuning of the U/f curve difficult.

Applying the *I/f Start* function may also prove useful in providing sufficient torque for the motor at startup.

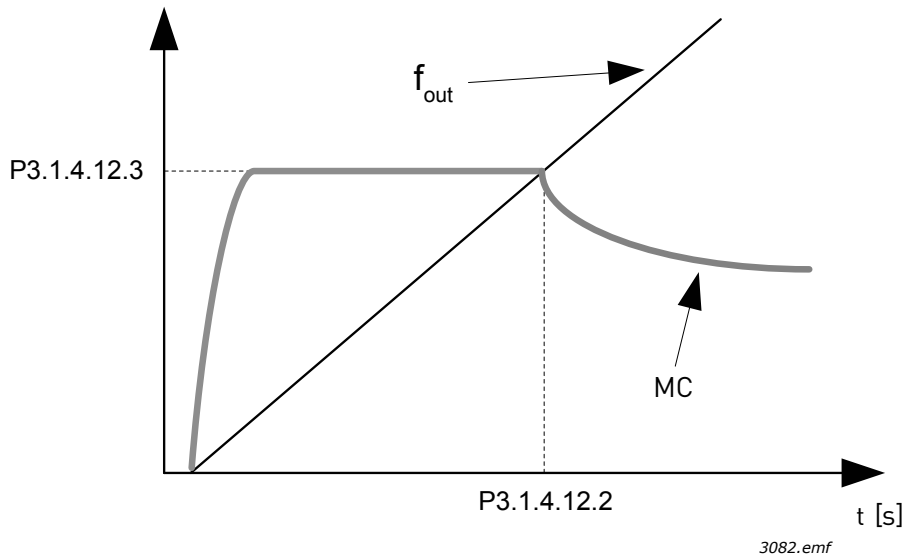

Figure 48. *I/f start* (MC = Motor Current), $P3.1.4.12.2$ = *I/f start frequency*, $P3.1.4.12.3$ = *I/f start current*

P3.1.4.12 I/F START (ID 534)

If the function is activated, the drive is set to current control mode and a constant current defined by $P3.1.4.11.3$ is fed to the motor until the drive output frequency exceeds the level defined with $P3.1.4.11.2$. When the output frequency has increased above *I/f Start Frequency* level, drive operation mode is changed smoothly back to normal U/f control mode.

P3.1.4.12.2 I/F START FREQUENCY (ID 535)

I/f start function is used when the drive's output frequency is below this frequency limit. When the output frequency exceeds this limit, the drive operation mode is changed back to normal U/f control mode.

P3.1.4.12.3 I/F START CURRENT (ID 536)

This parameter defines the current to be fed to the motor when the *I/f start* function is activated.

8.2 START/STOP SETUP

Start/Stop commands are given differently depending on the control place.

Remote control place (I/O A): Start, stop and reverse commands are controlled by 2 digital inputs chosen with parameters P3.5.1.1 Control signal 1 A, P3.5.1.2 Control signal 2 A and P3.5.1.3 Control signal 3 A. The functionality/logic for these inputs is then selected with parameter P3.2.6 I/O A Logic (in this group).

Remote control place (I/O B): Start, stop and reverse commands are controlled by 2 digital inputs chosen with parameters P3.5.1.3 Control signal 3 A, P3.5.1.4 Control signal 1 B and P3.5.1.5 Control signal 2 B. The functionality/logic for these inputs is then selected with parameter P3.2.7 I/O B Logic (in this group).

Local control place (Keypad): Start and stop commands come from the keypad buttons, while the direction of rotation is selected by the parameter P3.3.1.9.

Remote control place (Fieldbus): Start, stop and reverse commands come from fieldbus.

P3.2.5 STOP FUNCTION (ID 506)

Table 105.

Selection number	Selection name	Description
0	Coasting	The motor is allowed to stop on its own inertia. The control by the drive is discontinued and the drive current drops to zero as soon as the stop command is given.
1	Ramp	After the Stop command, the speed of the motor is decelerated according to the set deceleration parameters to zero speed.

P3.2.6 I/O A START/STOP LOGIC (ID 300)

Values 0...4 offer possibilities to control the starting and stopping of the AC drive with digital signal connected to digital inputs. CS = Control signal.

The selections including the text 'edge' shall be used to exclude the possibility of an unintentional start when, for example, power is connected, re-connected after a power failure, after a fault reset, after the drive is stopped by Run Enable (Run Enable = False) or when the control place is changed to I/O control. **The Start/Stop contact must be opened before the motor can be started.**

The used stop mode is *Coasting* in all the examples.

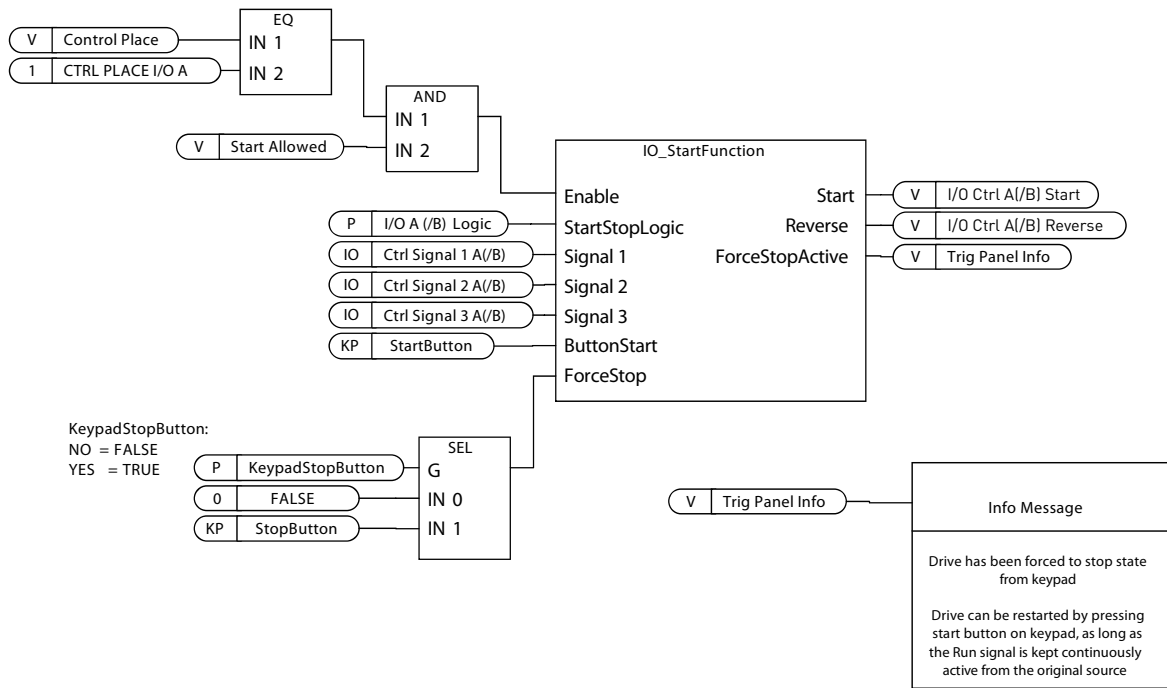

9144.emf

Figure 49. I/O A Start/Stop logic, block diagram

Table 106.

Selection number	Selection name	Note
0	CS1: Forward CS2: Backward	The functions take place when the contacts are closed.

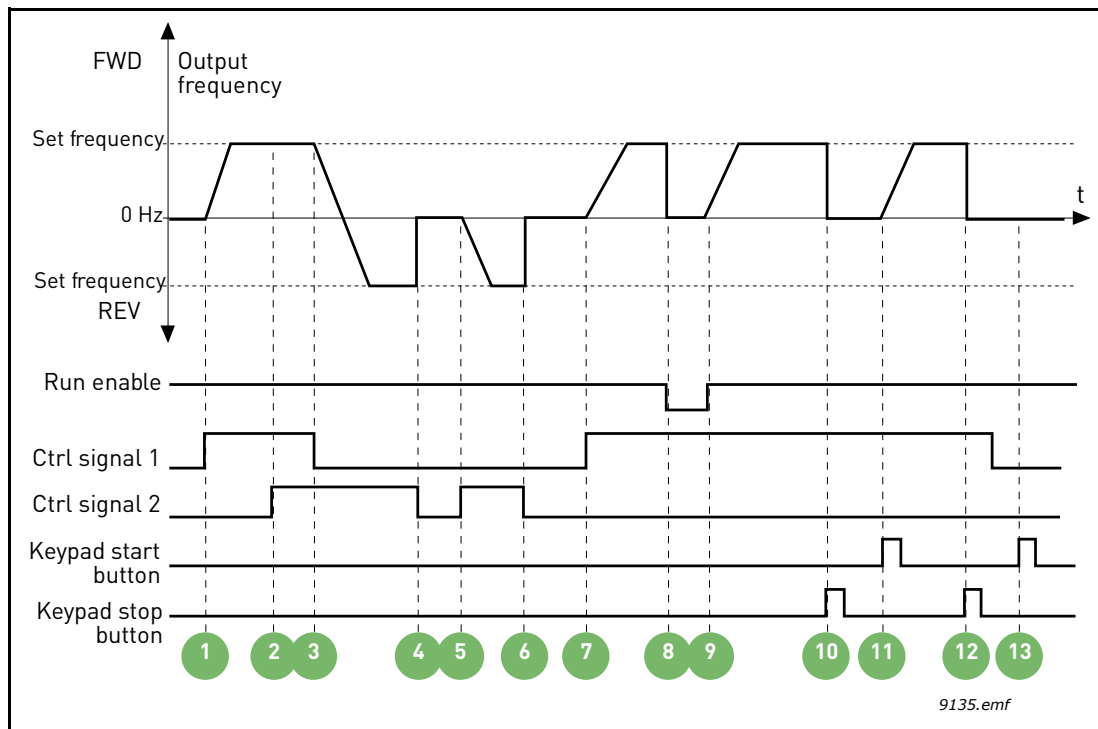

Figure 50. I/O A Start/Stop logic = 0

Explanations:

Table 107.

1	Control signal (CS) 1 activates causing the output frequency to rise. The motor runs forward.	8	Run enable signal is set to FALSE, which drops the frequency to 0. The run enable signal is configured with parameter P3.5.1.15..
2	CS2 activates which, however, has no effect on the output frequency because the first selected direction has the highest priority.	9	Run enable signal is set to TRUE, which causes the frequency to rise towards the set frequency because CS1 is still active.
3	CS1 is inactivated which causes the direction to start changing (FWD to REV) because CS2 is still active.	10	Keypad stop button is pressed and the frequency fed to the motor drops to 0. (This signal only works if P3.2.3 Keypad stop button = Yes)
4	CS2 inactivates and the frequency fed to the motor drops to 0.	11	The drive starts through pushing the Start button on the keypad.
5	CS2 activates again causing the motor to accelerate (REV) towards the set frequency.	12	The keypad stop button is pushed again to stop the drive.
6	CS2 inactivates and the frequency fed to the motor drops to 0.	13	The attempt to start the drive through pushing the Start button is not successful because CS1 is inactive.
7	CS1 activates and the motor accelerates (FWD) towards the set frequency		

Table 108.

Selection number	Selection name	Description
1	CS1: Forward (edge) CS2: Inverted stop CS3: Backward (edge)	For 3-wire control (pulse control)

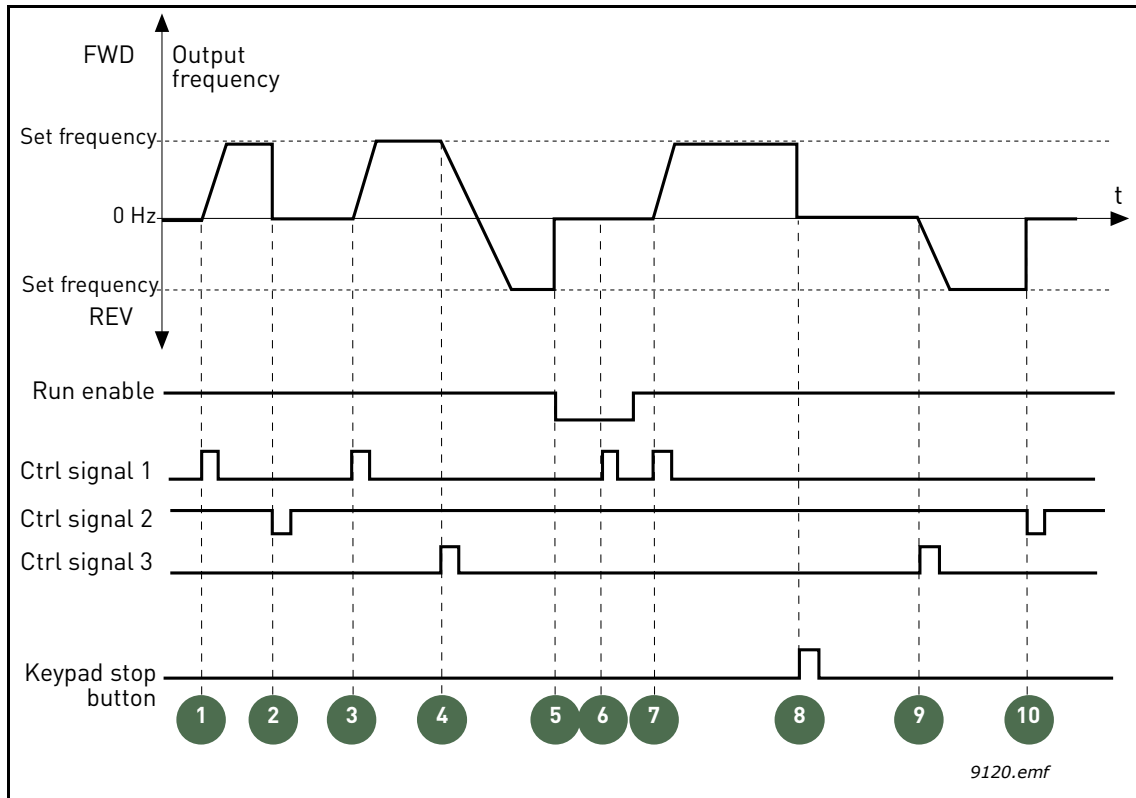

Figure 51. I/O A Start/Stop logic = 1

Explanations:

Table 109.

1	Control signal (CS) 1 activates causing the output frequency to rise. The motor runs forward.	6	Start attempt with CS1 is not successful because Run enable signal is still FALSE.
2	CS2 inactivates causing the frequency to drop to 0.	7	CS1 activates and the motor accelerates (FWD) towards the set frequency because the Run enable signal has been set to TRUE.
3	CS1 activates causing the output frequency to rise again. The motor runs forward.	8	Keypad stop button is pressed and the frequency fed to the motor drops to 0. (This signal only works if P3.2.3 Keypad stop button = Yes)
4	CS3 activates causing the direction to start changing (FWD to REV).	9	CS3 activates causing the motor to start and run backwards.
5	Run enable signal is set to FALSE, which drops the frequency to 0. The run enable signal is configured with parameter 3.5.1.15.	10	CS2 inactivates causing the frequency to drop to 0.

Table 110.

Selection number	Selection name	Note
2	CS1: Forward (edge) CS2: Backward (edge)	Shall be used to exclude the possibility of an unintentional start. The Start/Stop contact must be opened before the motor can be restarted.

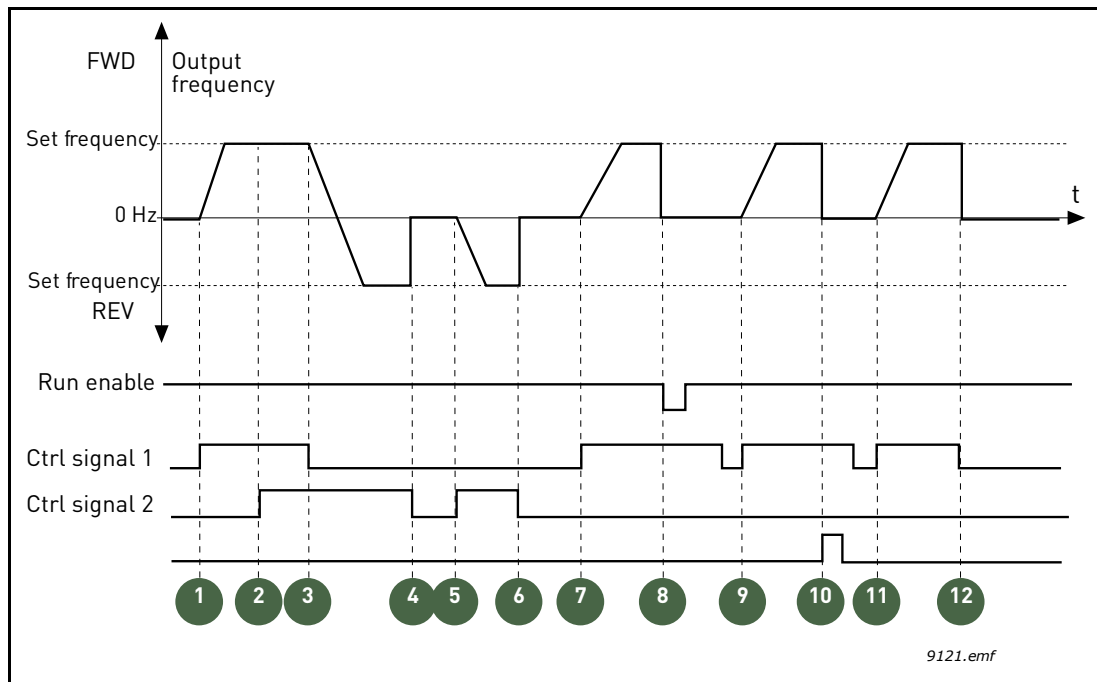

Figure 52. I/O A Start/Stop logic = 2

Explanations:

Table 111.

1	Control signal (CS) 1 activates causing the output frequency to rise. The motor runs forward.	7	CS1 activates and the motor accelerates (FWD) towards the set frequency
2	CS2 activates which, however, has no effect on the output frequency because the first selected direction has the highest priority.	8	Run enable signal is set to FALSE, which drops the frequency to 0. The run enable signal is configured with parameter P3.5.1.15.
3	CS1 is inactivated which causes the direction to start changing (FWD to REV) because CS2 is still active.	9	Run enable signal is set to TRUE, which, unlike if value 0 is selected for this parameter, has no effect because rising edge is required to start even if CS1 is active.
4	CS2 inactivates and the frequency fed to the motor drops to 0.	10	Keypad stop button is pressed and the frequency fed to the motor drops to 0. (This signal only works if P3.2.3 Keypad stop button = Yes)
5	CS2 activates again causing the motor to accelerate (REV) towards the set frequency.	11	CS1 is opened and closed again which causes the motor to start.
6	CS2 inactivates and the frequency fed to the motor drops to 0.	12	CS1 inactivates and the frequency fed to the motor drops to 0.

Table 112.

Selection number	Selection name	Note
3	CS1: Start CS2: Reverse	

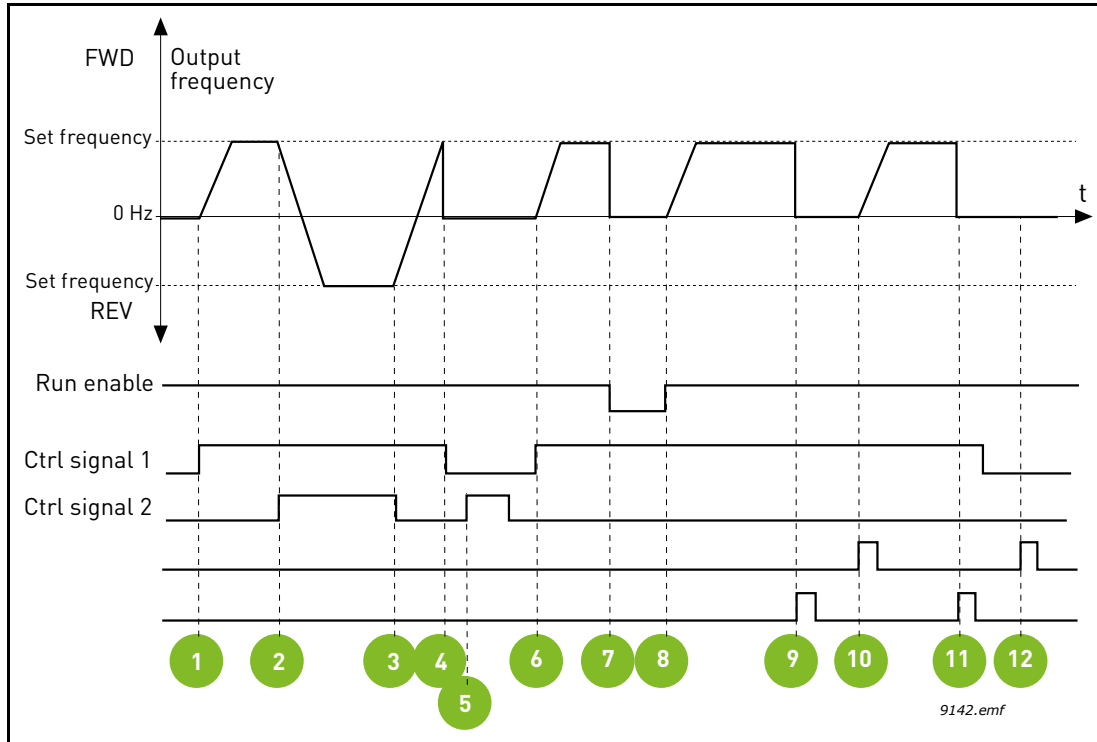

Figure 53. I/O A Start/Stop logic = 3

Table 113.

1	Control signal (CS) 1 activates causing the output frequency to rise. The motor runs forward.	7	Run enable signal is set to FALSE, which drops the frequency to 0. The run enable signal is configured with parameter P3.5.1.15.
2	CS2 activates which causes the direction to start changing (FWD to REV).	8	Run enable signal is set to TRUE, which causes the frequency to rise towards the set frequency because CS1 is still active.
3	CS2 is inactivated which causes the direction to start changing (REV to FWD) because CS1 is still active.	9	Keypad stop button is pressed and the frequency fed to the motor drops to 0. (This signal only works if P3.2.3 Keypad stop button = Yes)
4	Also CS1 inactivates and the frequency drops to 0.	10	The drive starts through pushing the Start button on the keypad.
5	Despite the activation of CS2, the motor does not start because CS1 is inactive.	11	The drive is stopped again with the stop button on the keypad.
6	CS1 activates causing the output frequency to rise again. The motor runs forward because CS2 is inactive.	12	The attempt to start the drive through pushing the Start button is not successful because CS1 is inactive.

Table 114.

Selection number	Selection name	Note
4	CS1: Start (edge) CS2: Reverse	Shall be used to exclude the possibility of an unintentional start. The Start/Stop contact must be opened before the motor can be restarted.

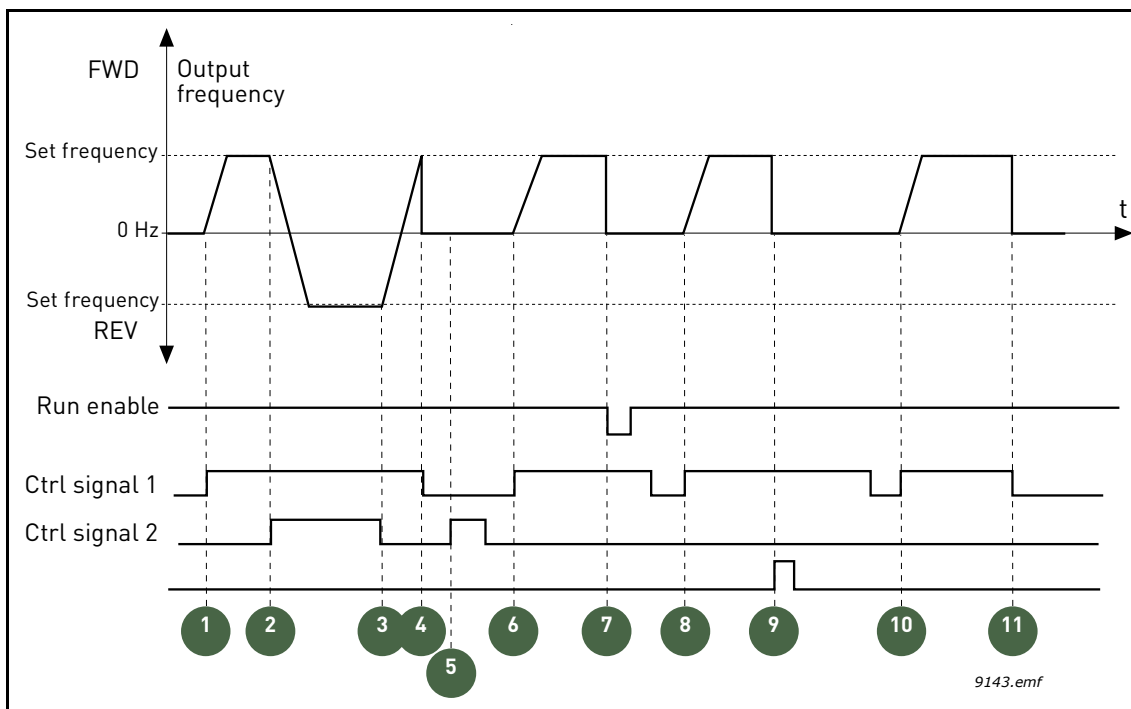

Figure 54. I/O A Start/Stop logic = 4

Table 115.

1	Control signal (CS) 1 activates causing the output frequency to rise. The motor runs forward because CS2 is inactive.	7	Run enable signal is set to FALSE, which drops the frequency to 0. The run enable signal is configured with parameter P3.5.1.15.
2	CS2 activates which causes the direction to start changing (FWD to REV).	8	Before a successful start can take place, CS1 must be opened and closed again.
3	CS2 is inactivated which causes the direction to start changing (REV to FWD) because CS1 is still active.	9	Keypad stop button is pressed and the frequency fed to the motor drops to 0. (This signal only works if P3.2.3 Keypad stop button = Yes)
4	Also CS1 inactivates and the frequency drops to 0.	10	Before a successful start can take place, CS1 must be opened and closed again.
5	Despite the activation of CS2, the motor does not start because CS1 is inactive.	11	CS1 inactivates and the frequency drops to 0.
6	CS1 activates causing the output frequency to rise again. The motor runs forward because CS2 is inactive.		

8.3 REFERENCES

8.3.1 FREQUENCY REFERENCE

The frequency reference source is programmable for all control places except *PC*, which always takes the reference from the PC tool.

Remote control place (I/O A): The source of frequency reference can be selected with parameter P3.3.1.5.

Remote control place (I/O B): The source of frequency reference can be selected with parameter P3.3.1.6.

Local control place (Keypad): If the default selection for parameter P3.3.1.7 is used the reference set with parameter P3.3.1.8 applies.

REMOTE CONTROL PLACE (FIELD BUS): *THE FREQUENCY REFERENCE COMES FROM FIELD BUS IF THE DEFAULT VALUE FOR PARAMETER P3.3.1.10 IS KEPT.*

8.3.2 PRESET FREQUENCIES

P3.3.3.1 PRESET FREQUENCY MODE (ID 182)

You can use the preset frequency parameters to define certain frequency references in advance. These references are then applied by activating/inactivating digital inputs connected to parameters P3.3.3.10, P3.3.3.11 and P3.3.3.12 (*Preset frequency selection 0, Preset frequency selection 1 and Preset frequency selection 2*).

Two different logics can be selected:

Table 116.

Selection number	Selection name	Description
0	Binary coded	Combine activated inputs according to Table 118 to choose the Preset frequency needed.
1	Number (of inputs used)	According to how many of the inputs assigned for <i>Preset frequency selections</i> are active you can apply the <i>Preset frequencies</i> 1 to 3.

P3.3.3.2 TO (ID 180)

P3.3.3.9 PRESET FREQUENCIES 0 TO 7 (ID 130)

Value '0' selected for parameter P3.3.3.1:

Preset frequency 0 can be chosen as reference by selecting Value 0 (Preset Frequency 0) for parameter P3.3.1.5 I/O A reference selection, P3.3.1.6 I/O B reference Selection, P3.3.1.7 Keypad Ctrl reference selection and P3.3.1.10 Fieldbus control reference selection.

Other preset frequencies 1 to 7 are selected as reference by dedicating digital inputs for parameters P3.3.3.10, P3.3.3.11 and/or P3.3.3.12. Combinations of active digital inputs determine the used preset frequency according to Table 118 below.

The values of the preset frequencies are automatically limited between the minimum and maximum frequencies (P3.3.1.1 and P3.3.1.2). See table below:

Table 117.

Required action	Activated frequency
Choose value 1 for parameters P3.3.1.5, P3.3.1.6, P3.3.1.7 and P3.3.1.10.	Preset frequency 0

Preset frequencies 1 to 7:

Table 118. Selection of preset frequencies; = input activated

Activate digital input for parameter			Activated frequency
<input type="checkbox"/> P3.3.3.12	<input type="checkbox"/> P3.3.3.11	<input type="checkbox"/> P3.3.3.10	Preset frequency 1
<input type="checkbox"/> P3.3.3.12	<input type="checkbox"/> P3.3.3.11	<input type="checkbox"/> P3.3.3.10	Preset frequency 2
<input type="checkbox"/> P3.3.3.12	<input type="checkbox"/> P3.3.3.11	<input type="checkbox"/> P3.3.3.10	Preset frequency 3
<input type="checkbox"/> P3.3.3.12	<input type="checkbox"/> P3.3.3.11	<input type="checkbox"/> P3.3.3.10	Preset frequency 4
<input type="checkbox"/> P3.3.3.12	<input type="checkbox"/> P3.3.3.11	<input type="checkbox"/> P3.3.3.10	Preset frequency 5
<input type="checkbox"/> P3.3.3.12	<input type="checkbox"/> P3.3.3.11	<input type="checkbox"/> P3.3.3.10	Preset frequency 6
<input type="checkbox"/> P3.3.3.12	<input type="checkbox"/> P3.3.3.11	<input type="checkbox"/> P3.3.3.10	Preset frequency 7

Value '1' selected for parameter P3.3.3.1:

According to how many of the inputs assigned for Preset frequency selections are active, you can apply the Preset frequencies 1 to 3.

Table 119. Selection of preset frequencies; = input activated

Activated input			Activated frequency
<input type="checkbox"/> P3.3.3.12	<input type="checkbox"/> P3.3.3.11	<input type="checkbox"/> P3.3.3.10	Preset frequency 1
<input type="checkbox"/> P3.3.3.12	<input type="checkbox"/> P3.3.3.11	<input type="checkbox"/> P3.3.3.10	Preset frequency 1
<input type="checkbox"/> P3.3.3.12	<input type="checkbox"/> P3.3.3.11	<input type="checkbox"/> P3.3.3.10	Preset frequency 1
<input type="checkbox"/> P3.3.3.12	<input type="checkbox"/> P3.3.3.11	<input type="checkbox"/> P3.3.3.10	Preset frequency 2
<input type="checkbox"/> P3.3.3.12	<input type="checkbox"/> P3.3.3.11	<input type="checkbox"/> P3.3.3.10	Preset frequency 2
<input type="checkbox"/> P3.3.3.12	<input type="checkbox"/> P3.3.3.11	<input type="checkbox"/> P3.3.3.10	Preset frequency 2
<input type="checkbox"/> P3.3.3.12	<input type="checkbox"/> P3.3.3.11	<input type="checkbox"/> P3.3.3.10	Preset frequency 3

P3.3.3.10 PRESET FREQUENCY SELECTION 0 (ID 419)

P3.3.3.11 PRESET FREQUENCY SELECTION 1 (ID 420)

P3.3.3.12 PRESET FREQUENCY SELECTION 2 (ID 421)

Connect a digital input to these functions (see chapter 8.5.1 Programming of digital and analogue inputs) to be able to apply Preset frequencies 1 to 7 (see Table 118 above).

8.3.3 MOTOR POTENTIOMETER PARAMETERS

With a motor potentiometer function, the user can increase and decrease the output frequency. By connecting a digital input to parameter P3.3.4.1 (*Motor potentiometer UP*) and having the digital input signal active, the output frequency will rise as long as the signal is active. The parameter P3.3.4.2 (*Motor potentiometer DOWN*) works vice versa, decreasing the output frequency.

The rate how the output frequency either rises or falls when Motor Potentiometer Up or Down is activated is determined by the *Motor potentiometer ramp time* (P3.3.4.3)

The Motor potentiometer reset parameter (P3.3.4.4) is used to choose whether to reset (set to MinFreq) the Motor Potentiometer frequency reference when stopped or when powered down.

Motor potentiometer frequency reference is available in all control places in menu Group 3.3: References. The motor potentiometer reference can be changed only when the drive is in run state.

P3.3.4.1 MOTOR POTENTIOMETER UP (ID 418)

P3.3.4.2 MOTOR POTENTIOMETER DOWN (ID 417)

With a motor potentiometer, the user can increase and decrease the output frequency. By connecting a digital input to parameter P3.3.4.1 (*Motor potentiometer UP*) and having the digital input signal active, the output frequency will rise as long as the signal is active. The parameter P3.3.4.2 (*Motor potentiometer DOWN*) works vice versa, decreasing the output frequency.

The rate how the output frequency either rises or falls when Motor Potentiometer Up or Down is activated is determined by the *Motor potentiometer ramp time* (P3.3.4.3) and the Ramp acceleration/deceleration times (P3.4.1.2/P3.4.1.3).

The Motor potentiometer reset parameter (P3.3.4.4) will set the frequency reference to zero, if activated.

P3.3.4.4 MOTOR POTENTIOMETER RESET (ID 367)

Defines the logic for resetting the motor potentiometer frequency reference.

Selection number	Selection name	Note
0	No reset	The previous motor potentiometer frequency reference is kept past the stop state and stored to memory in case of powerdown.
1	Stop state	Motor potentiometer frequency reference is set to zero when the drive is in stop state or the drive is powered down.
2	Powered down	Motor potentiometer frequency reference is set to zero only in a powerdown situation.

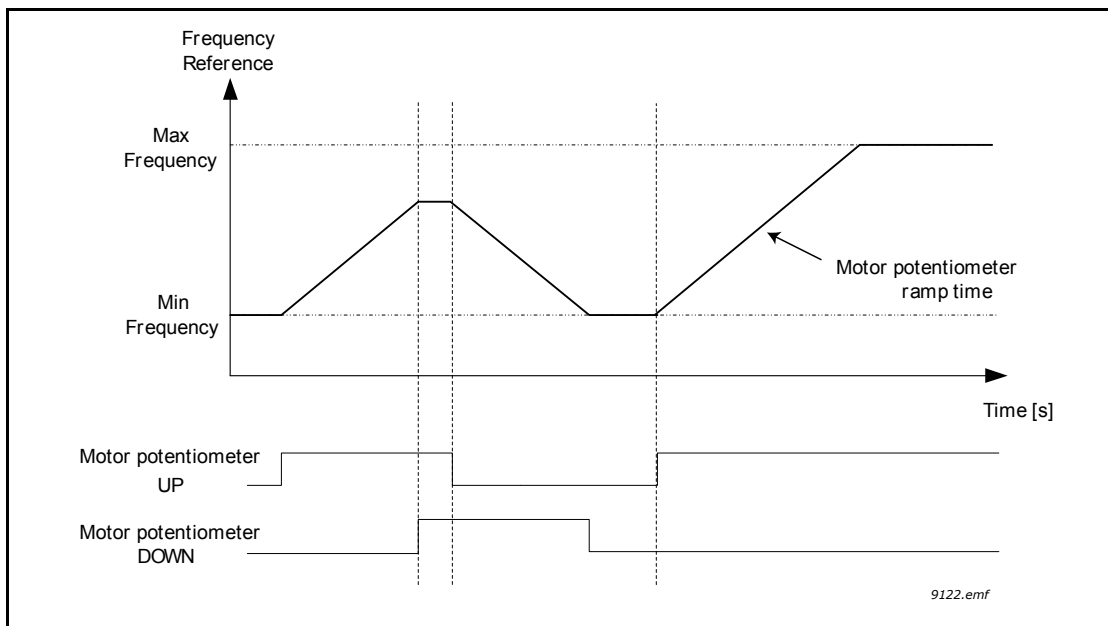

Figure 55. Motor potentiometer parameters

8.3.4 FLUSHING PARAMETERS

The Flushing function is used for a momentary overriding of normal control. The function can be used for e.g. flushing the pipeline.

The Flushing function will start the drive at a selected reference without an additional start command regardless of the control place.

P3.3.6.1 FLUSHING REFERENCE ACTIVATION (ID 530)

The parameter defines the digital input signal, which is used to select the frequency reference for Flushing function and force the drive to start.

The flushing frequency reference is bidirectional and the reverse command does not affect the direction of the flushing reference.

NOTE! Activation of the digital input will start the drive.

P3.3.6.2 FLUSHING REFERENCE (ID 1239)

The parameter defines the frequency reference for Flushing function. Reference is bidirectional and the reverse command does not affect the direction of the flushing reference. Reference for forward direction is defined as a positive value and reverse direction as a negative value.

8.4 RAMPS AND BRAKES SETUP

P3.4.1.1 RAMP 1 SHAPE (ID 500)

P3.4.2.1 RAMP 2 SHAPE (ID 501)

The start and end of acceleration and deceleration ramps can be smoothed with these parameters. Setting the value to 0.0% gives a linear ramp shape, which causes acceleration and deceleration to act immediately to the changes in the reference signal.

Setting the value to 1.0...100.0% for this parameter produces an S-shaped acceleration/ deceleration. This function is typically used to reduce mechanical erosion and current spikes when the reference is changed.

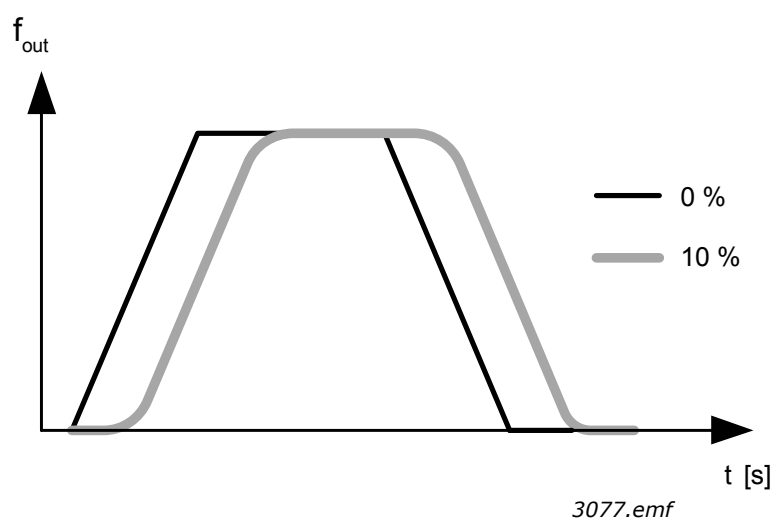

Figure 56.

P3.4.2.5 RAMP 2 THRESHOLD FREQUENCY (ID 533)

The parameter defines the output frequency limit, above which the second ramp times and ramp shapes are used.

The function can be used e.g. in deep **well** pump applications, where faster ramp times are needed when the pump is starting or stopping (running below the minimum frequency).

Second ramp times are activated when the drive output frequency exceeds the limit defined by this parameter. The function is disabled when the value of the parameter is set to zero.

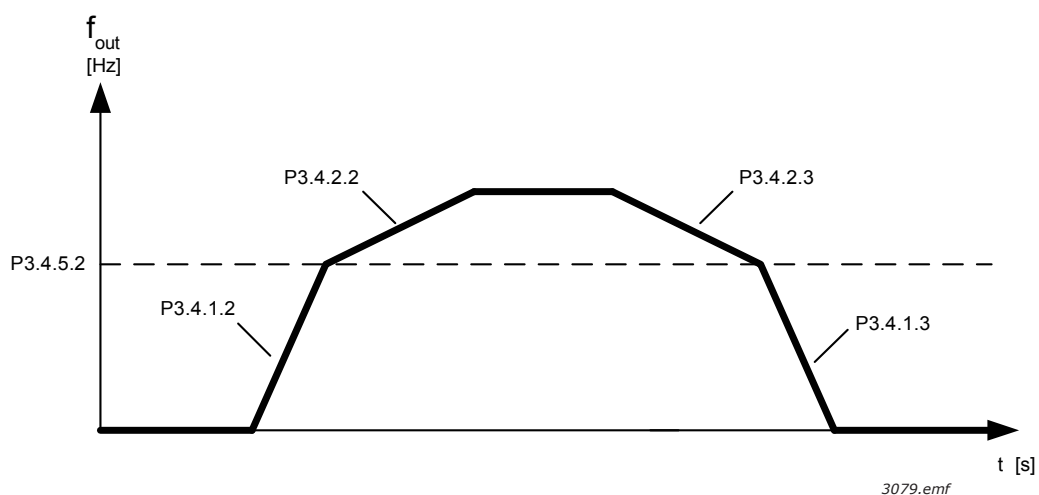

Figure 57. Ramp 2 activation when output frequency exceeds the threshold level.
 (P.3.4.5.2 = Ramp threshold freq., P3.4.1.2 = Acc. time 1, P3.4.2.2 = Acc. time 2, P3.4.1.3 = Dec. time 1, P3.4.2.3 = Dec. time 2)

P3.4.5.1 FLUX BRAKING (ID 520)

Instead of DC braking, flux braking is a useful way to raise the braking capacity in cases where additional brake resistors are not needed.

When braking is needed, the frequency is reduced and the flux in the motor is increased, which in turn increases the motor's capability to brake. Unlike DC braking, the motor speed remains controlled during braking.

The flux braking can be set ON or OFF.

NOTE! Flux braking converts the energy into heat in the motor, and should be used intermittently to avoid motor damage.

8.5 I/O CONFIGURATION

8.5.1 PROGRAMMING OF DIGITAL AND ANALOGUE INPUTS

The programming of inputs in the Vacon® 100 FLOW is very flexible. The available inputs on the standard and optional I/O can be used for various functions according to the operator's choice. The available I/O can be expanded with optional boards to be inserted in board slots C, D and E. More information on the installation of optional boards you will find in the Installation manual.

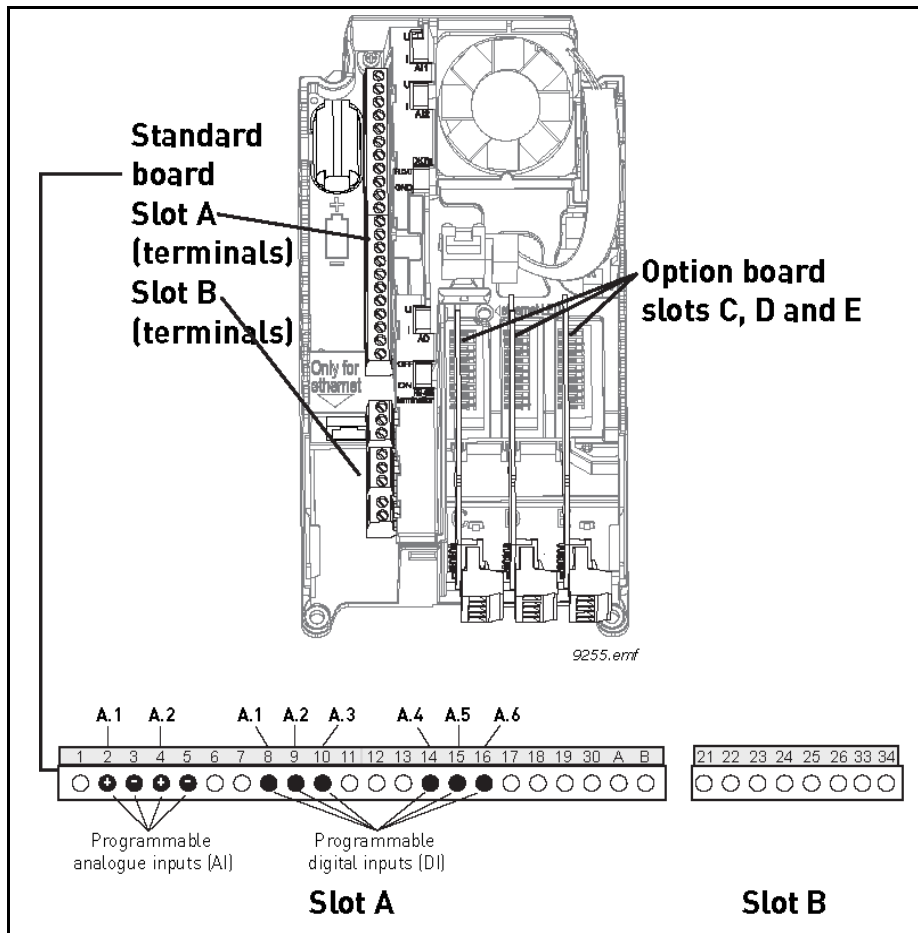

Figure 58. Board slots and programmable inputs

8.5.1.1 Digital inputs

The applicable functions for digital inputs are arranged as parameters in parameter group M3.5.1. The value given to the parameter is a reference to the digital input you choose to use for the function. The list of functions that you can assign to the available digital inputs is presented in Table 28. Digital input settings in chapter 4.

Example

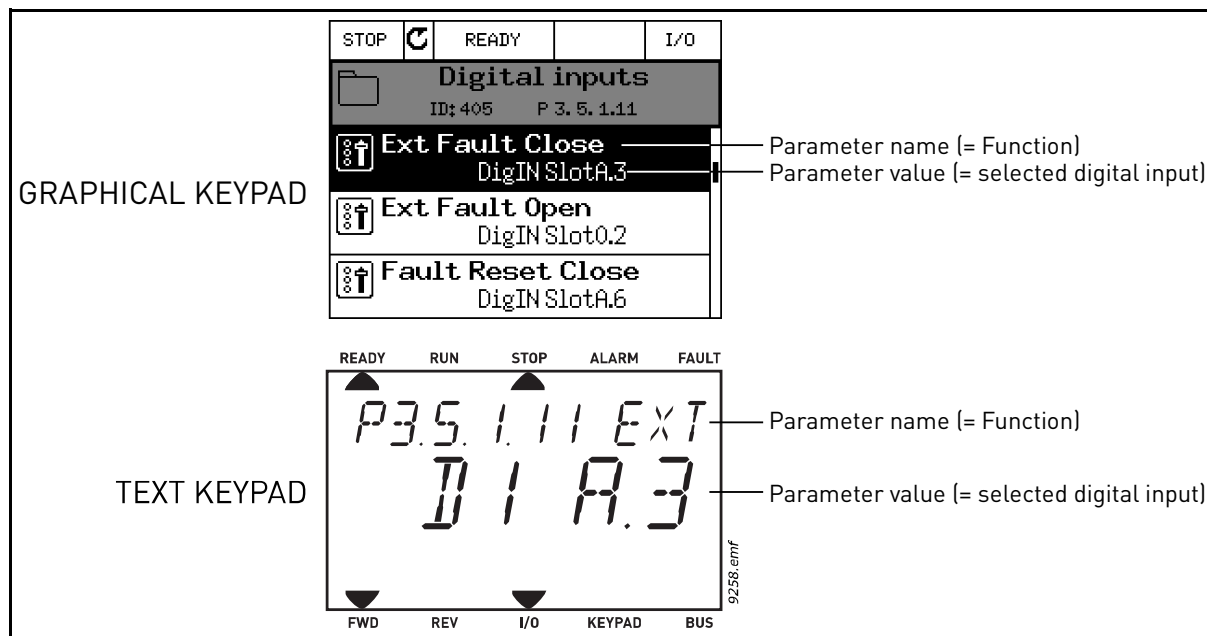

Figure 59.

Given the standard I/O board compilation on the Vacon® 100 AC drive, there are 6 digital inputs available (Slot A terminals 8, 9, 10, 14, 15 and 16). In the programming view, these inputs are referred to as follows:

Table 120.

Input type (Graphical keypad)	Input type (Text keypad)	Slot	Input #	Explanation
DigIN	dl	A.	1	Digital input #1 (terminal 8) on board in Slot A (standard I/O board).
DigIN	dl	A.	2	Digital input #2 (terminal 9) on board in Slot A (standard I/O board).
DigIN	dl	A.	3	Digital input #3 (terminal 10) on board in Slot A (standard I/O board).
DigIN	dl	A.	4	Digital input #4 (terminal 14) on board in Slot A (standard I/O board).
DigIN	dl	A.	5	Digital input #5 (terminal 15) on board in Slot A (standard I/O board).
DigIN	dl	A.	6	Digital input #6 (terminal 16) on board in Slot A (standard I/O board).

In the example 61, the function *External fault close* located in menu M3.5.1 as parameter P3.5.1.11, is by default given the value *DigIN SlotA.3* (graphical keypad) or *dI A.3* (text keypad).

This means that the function *External fault close* is now controlled with a digital signal to digital input DI3 (terminal 10).

This is what is shown in Table 28. Digital input settings in chapter 4:

Code	Parameter	Default	ID	Description
P3.5.1.11	External fault close	DigIN SlotA.3	405	FALSE = OK TRUE = External fault

Assume you need to change the selected input. Instead of DI3 you wish to use DI6 (terminal 16) on the standard I/O. Do as instructed here:

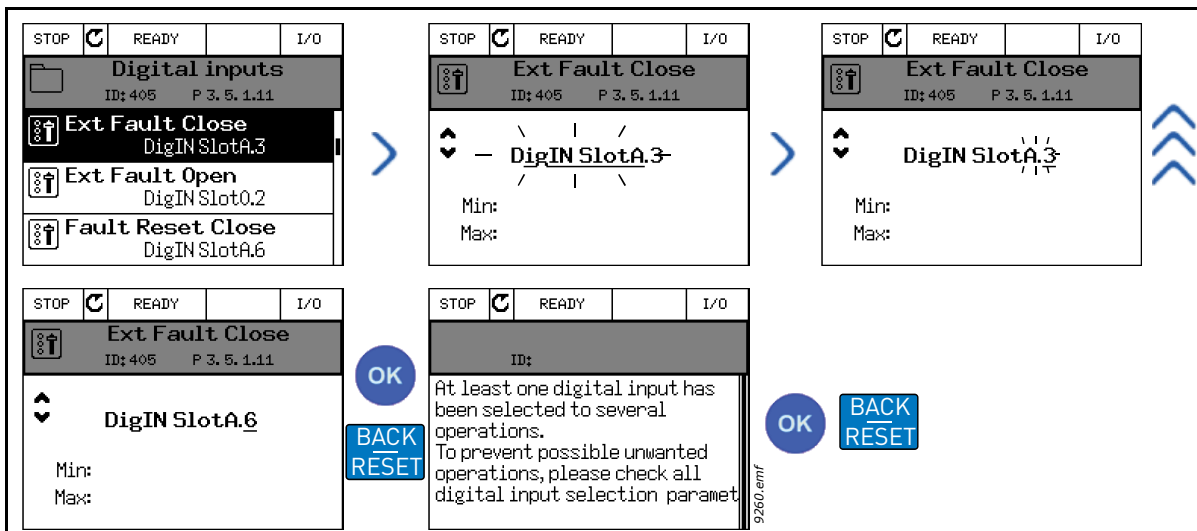

Figure 60. Programming digital inputs with graphical keypad

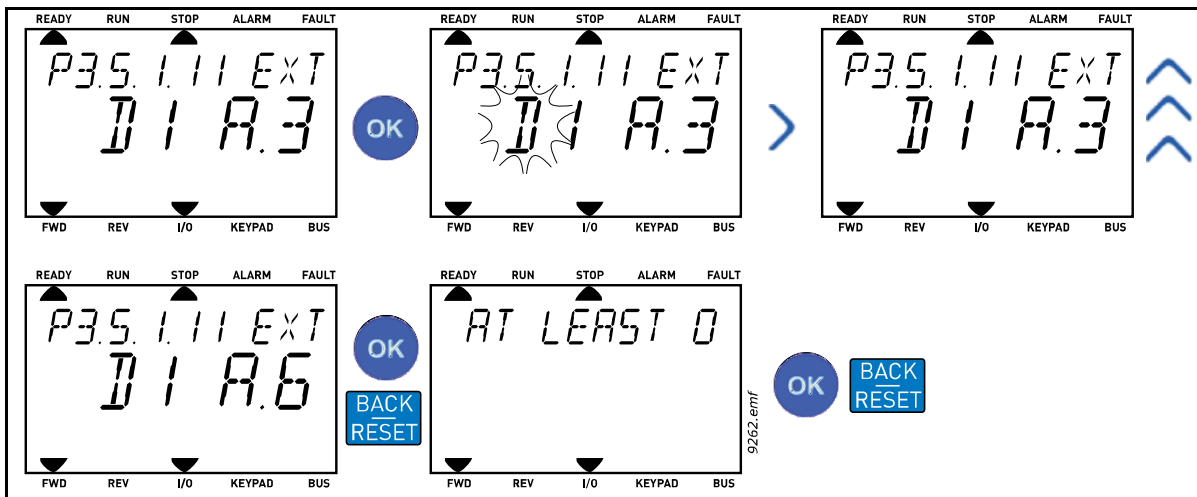

Figure 61. Programming digital inputs with text keypad

Table 121. Programming digital inputs

PROGRAMMING INSTRUCTIONS	
Graphical keypad	Text keypad
1. Select the parameter and push the <i>Arrow right</i> button.	1. Select the parameter and push the <i>OK</i> button.
2. You are now in the <i>Edit</i> mode as the slot value <i>DigIN SlotA.</i> is blinking and underlined. (Should you have more digital inputs available in your I/O, for example, through inserted option boards in slots C , D or E , they can also be selected here.). See Figure 62.	2. You are now in the <i>Edit</i> mode as the letter <i>d</i> is blinking. (Should you have more digital inputs available in your I/O, for example, through inserted option boards in slots C , D or E , they can also be selected here.). See Figure 62.
3. Push the <i>Arrow right</i> button again to activate the terminal value 3.	3. Push the <i>Arrow right</i> button to activate the terminal value 3. The letter <i>d</i> stops blinking.
4. Push the <i>Arrow up</i> button three times to change the terminal value to 6. Confirm with <i>OK</i> button.	4. Push the <i>Arrow up</i> button three times to change the terminal value to 6. Confirm with <i>OK</i> button.
5. NOTE! If the digital input DI6 was already used for some other function a message is displayed. You might then want to change either of these selections.	5. NOTE! If the digital input DI6 was already used for some other function a message will scroll through the display. You might then want to change either of these selections.

Now, the function *External fault close* is controlled with a digital signal to digital input DI6 (terminal 16).

NOTE! The function is not assigned to any terminal, or, the the input is set to be always FALSE, if its value is DigIN Slot0.1 (graphical keypad) or dl 0.1 (text keypad). This is the default value of the majority of parameters in the group M3.5.1.

On the other hand, some inputs have been by default set to be always TRUE. Their value shows DigIN Slot0.2 (graphical keypad) or dl 0.2 (text keypad).

NOTE! Also Time Channels can be assigned to digital inputs. See more information in Table 63. Sleep function settings in chapter 4.

8.5.1.2 Analogue inputs

The target input for the analogue frequency reference signal can also be chosen from the available analogue inputs.

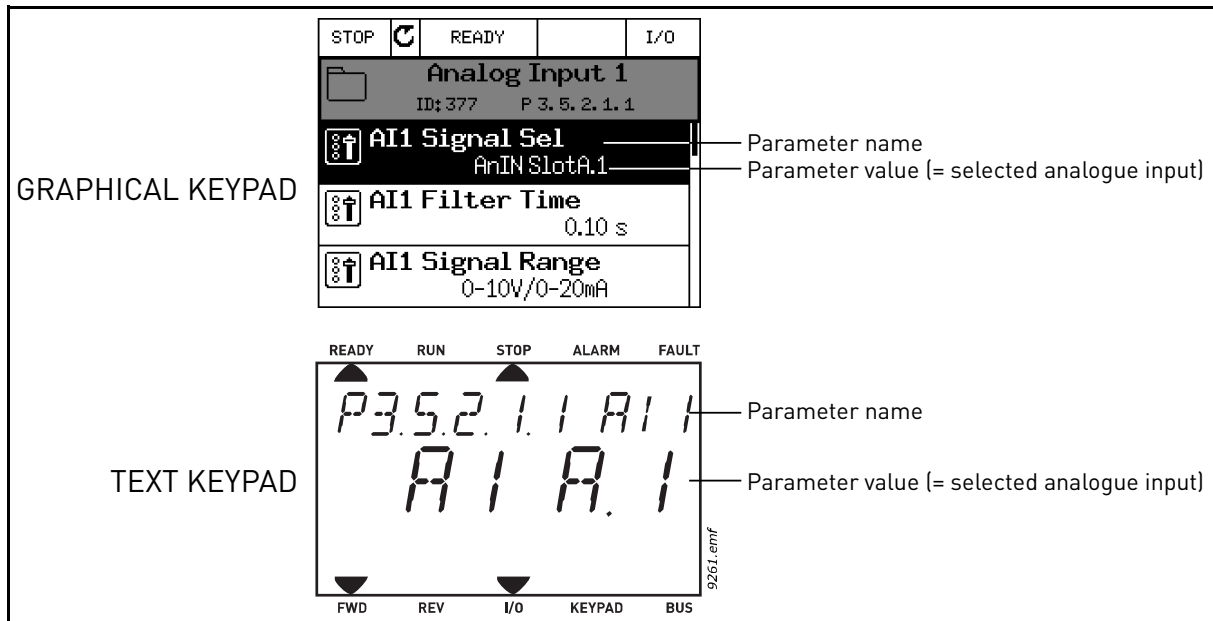

Figure 62.

Given the standard I/O board compilation on the Vacon® 100 AC drive, there are two analogue inputs available (Slot A terminals 2/3 and 4/5). In the programming view, these inputs are referred to as follows:

Table 122. Programming analogue inputs

Input type (Graphical keypad)	Input type (Text keypad)	Slot	Input #	Explanation
AnIN	AI	A.	1	Analogue input #1 (terminals 2/3) on board in Slot A (standard I/O board).
AnIN	AI	A.	2	Analogue input #2 (terminals 4/5) on board in Slot A (standard I/O board).

In the example 64, the parameter *AI1 signal selection* located in menu M3.5.2.1 with parameter code P3.5.2.1.1, is by default given the value *AnIN SlotA.1* (graphical keypad) or *AI A.1* (text keypad). This means that the target input for the analogue frequency reference signal AI1 is now the analogue input in terminals 2/3. Whether the signal is voltage or current, must be determined with the *dip switches*. See the Installation manual for more information.

This is what is shown in the parameter list in Table 29. General protections settings in chapter 4:

Code	Parameter	Min	Max	Unit	Default	ID	Description
P3.5.2.1.1	AI1 signal selection				AnIN SlotA.1	377	Connect the AI1 signal to the analogue input of your choice with this parameter. Programmable. See ch. 8.5.1

Assume you need to change the selected input. Instead of AI1 you wish to use the analogue input on your option board in slot C. Do as instructed here:

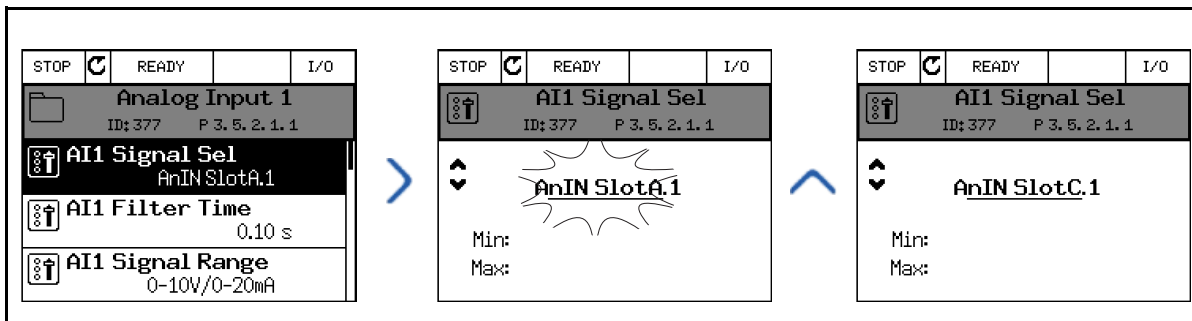

Figure 63. Programming analogue inputs with graphical keypad

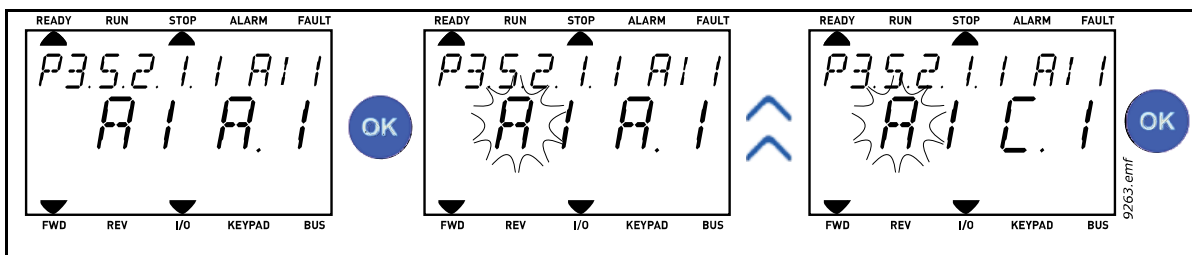

Figure 64. Programming analogue inputs with text keypad

PROGRAMMING INSTRUCTIONS	
Graphical keypad	Text keypad
1. Select the parameter and push the <i>Arrow right</i> button.	1. Select the parameter and push the <i>OK</i> button.
2. You are now in the <i>Edit</i> mode as the slot value <i>AnIN SlotA.</i> is blinking and underlined.	2. You are now in the <i>Edit</i> mode as the letter <i>A</i> is blinking.
3. Push the <i>Arrow up</i> button once to change the slot value to <i>AnIN SlotC.</i> Confirm with <i>OK</i> button.	3. Push the <i>Arrow up</i> button once to change the slot value to <i>C.</i> Confirm with <i>OK</i> button.

8.5.1.3 Descriptions of signal sources

Table 123. Descriptions of signal sources

Source	Function
Slot0.#	<p>Digital inputs: A digital signal can be forced to a constant OPEN or CLOSED state using this functionality. For example, some signals have been set to be always in CLOSED state by manufacturer, e.g parameter P3.5.1.15 (Run enable). Unless changed, Run enable signal is always on. # = 1: Always OPEN # = 2-10: Always CLOSED</p> <p>Analogue inputs (used for testing purposes): # = 1: Analogue input = 0% signal strength # = 2: Analogue input = 20% signal strength # = 3: Analogue input = 30% signal strength etc. # = 10: Analogue input = 100% signal strength</p>
SlotA.#	Number (#) corresponds to digital input in slot A.
SlotB.#	Number (#) corresponds to digital input in slot B.
SlotC.#	Number (#) corresponds to digital input in slot C.
SlotD.#	Number (#) corresponds to digital input in slot D.
SlotE.#	Number (#) corresponds to digital input in slot E.
TimeChannel.#	Number (#) corresponds to: 1=Time Channel1, 2=Time Channel2, 3=Time Channel3
Fieldbus CW.#	Number (#) refers to Control Word bit number.
FieldbusPD.#	Number (#) refers to Process Data 1 bit number.

8.5.2 DEFAULT ASSIGNMENTS OF PROGRAMMABLE INPUTS

Table 124. below presents the default assignments of programmable digital and analogue inputs in Vacon® 100 General-Purpose application.

Table 124. Default assignments of inputs

Input	Terminal(s)	Reference	Assigned function	Parameter code
DI1	8	A.1	Control signal 1 A	P3.5.1.1
DI2	9	A.2	Control signal 2 A	P3.5.1.2
DI3	10	A.3	External fault close	P3.5.1.11
DI4	14	A.4	Preset frequency selection 0	P3.5.1.21
DI5	15	A.5	Preset frequency selection 1	P3.5.1.22
DI6	16	A.6	External fault close	P3.5.1.13
AI1	2/3	A.1	AI1 signal selection	P3.5.2.1.1
AI2	4/5	A.2	AI2 signal selection	P3.5.2.2.1

8.5.3 DIGITAL INPUTS

Digital inputs are very flexible to use. Parameters are functions that are connected to the required digital input terminal. The digital inputs are represented as, for example, *DigIN Slot A.2*, meaning the second input on slot A.

It is also possible to connect the digital inputs to time channels, which are also represented as terminals.

NOTE! The statuses of digital inputs and the digital output can be monitored in the Multimonitoring view.

P3.5.1.15 RUN ENABLE (ID 407)

Contact open: Start of motor **disabled**

Contact closed: Start of motor **enabled**

The drive will always coast to stop.

P3.5.1.16 RUN INTERLOCK 1 (ID 1041)

P3.5.1.17 RUN INTERLOCK 2 (ID 1042)

The drive cannot be started, if any of the interlocks are open.

The function could be used for a damper interlock, preventing the drive to start with damper closed. The AC drive is stopped according to the selected function in P3.2.5 Stop function, if any of the interlocks are opened during run.

8.5.4 ANALOGUE INPUTS

P3.5.2.1.2 AI1 SIGNAL FILTER TIME (ID 378)

When this parameter is given a value greater than 0, the function that filters out disturbances from the incoming analogue signal is activated.

NOTE! Long filtering time makes the regulation response slower!

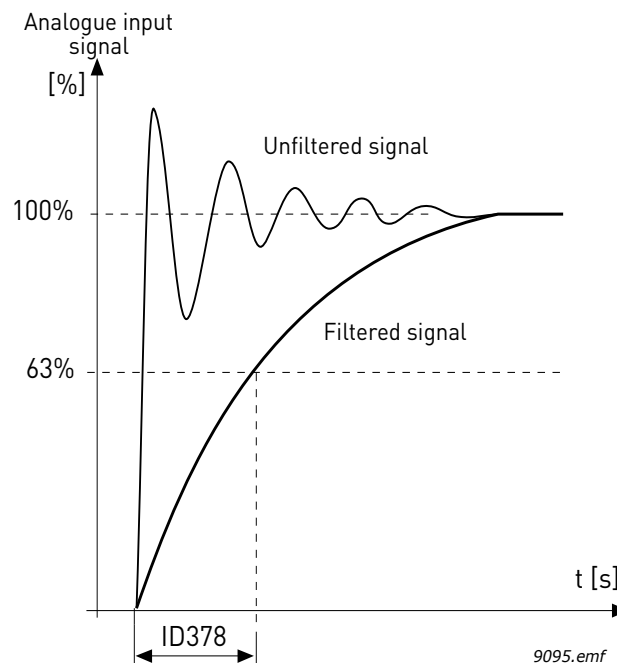

Figure 65. AI1 signal filtering

P3.5.2.1.3 AI1 SIGNAL RANGE (ID 379)

The signal range for the analogue signal can be selected as:

Type of the analogue input signal (current or voltage) is selected by the dip switches on the control board (see Installation manual).

In the following examples, the analogue input signal is used as a frequency reference. The figures show how the scaling of the analogue input signal is changed depending on the setting of this parameter.

Selection number	Selection name	Description
0	0...10 V/0...20 mA	Analogue input signal range 0...10 V or 0...20 mA (depending on dip switch settings on the control board). Input signal used 0...100%.

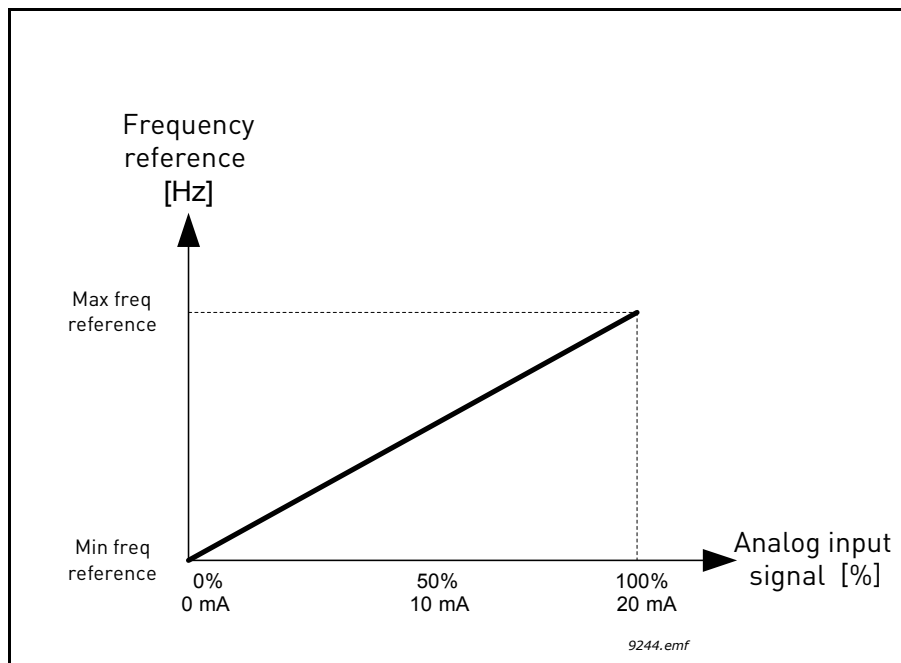

Figure 66. Analogue input signal range, selection '0'

Selection number	Selection name	Description
1	2...10 V/4...20 mA	Analogue input signal range 2...10 V or 4...20 mA (depending on dip switch settings on the control board). Input signal used 20...100%.

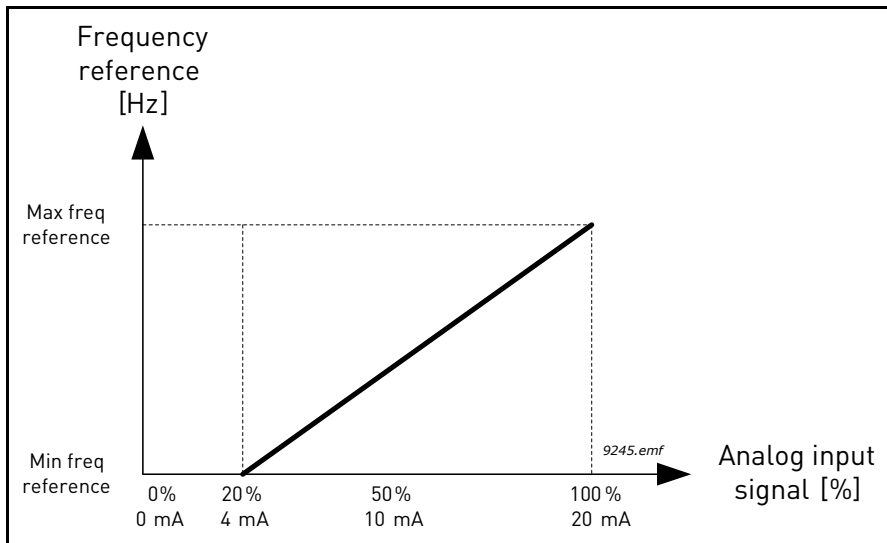

Figure 67. Analogue input signal range, selection '1'

P3.5.2.1.4 AI1 CUSTOM. MIN (ID 380)

P3.5.2.1.5 AI1 CUSTOM. MAX (ID 381)

These parameters allow you to freely adjust the analogue input signal range between -160...160%.

Example: If the analogue input signal is used as frequency reference and these parameters are set to 40...80%, the frequency reference is changed between the Minimum frequency reference and the Maximum frequency reference when the analogue input signal is changed between 8...16 mA.

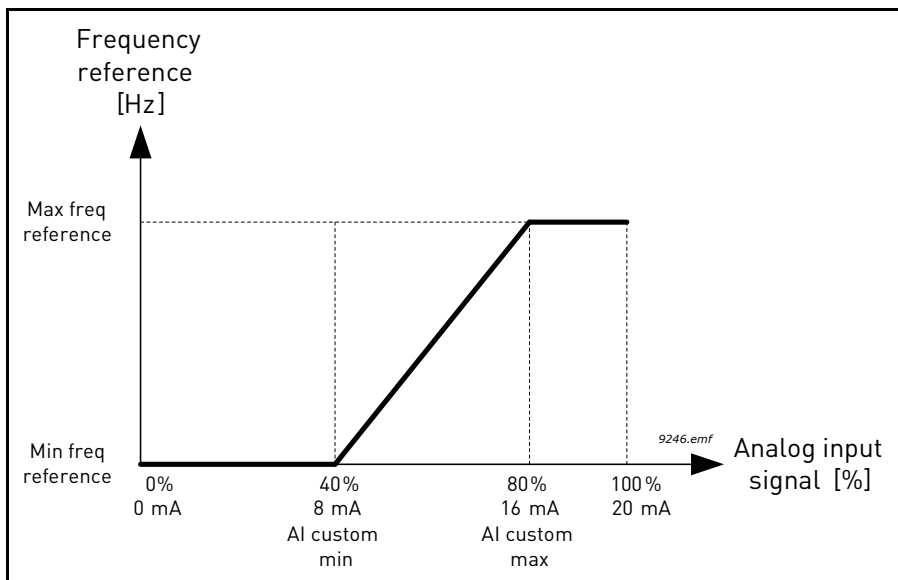

Figure 68. AI signal custom min/max

P3.5.2.1.6 AI1 SIGNAL INVERSION (ID 387)

Invert the analogue signal with this parameter.

In the following examples, the analogue input signal is used as frequency reference. The figures show how the scaling of the analogue input signal is changed depending on the setting of this parameter.

Selection number	Selection name	Description
0	Normal	No inversion. The analogue input signal value 0% corresponds to the Minimum frequency reference and the analogue input signal value 100% to the Maximum frequency reference.

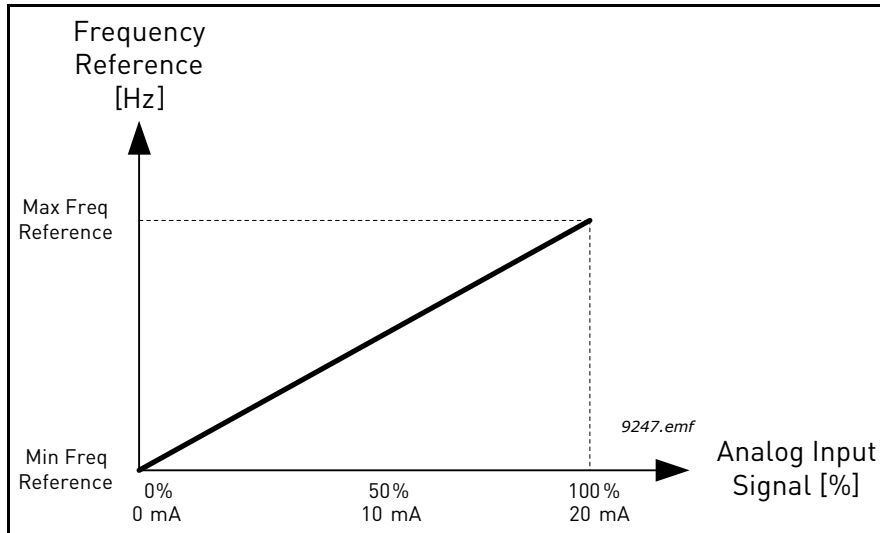

Figure 69. AI signal inversion, selection '0'

Selection number	Selection name	Description
1	Inverted	Signal inverted. The analogue input signal value 0% corresponds to the Maximum frequency reference and the analogue input signal value 100% to the Minimum frequency reference.

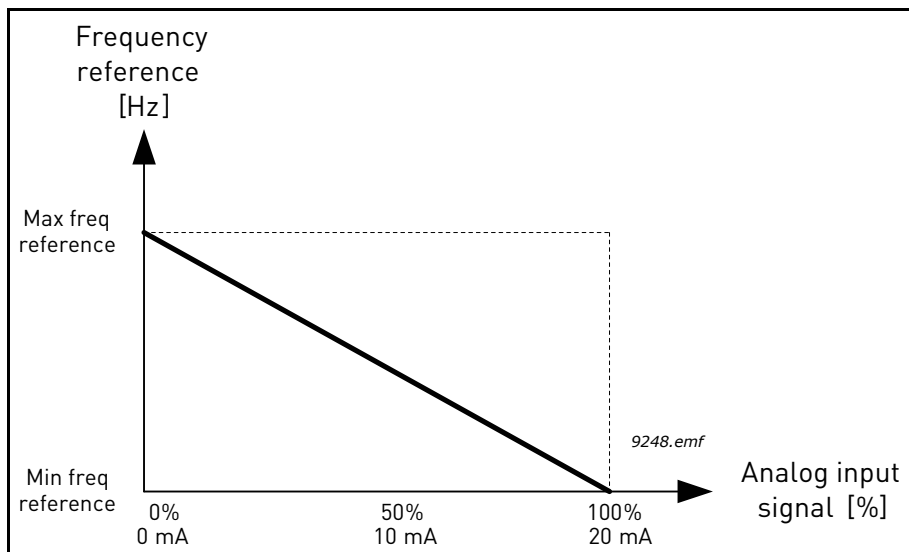

Figure 70. AI signal inversion, selection '1'

8.5.5 DIGITAL OUTPUTS

P3.5.3.2.1 BASIC RO1 FUNCTION (ID 11001)

Table 125. Output signals via RO1

Selection	Selection name	Description
0	Not used	Output not used
1	Ready	The AC drive is ready to operate
2	Run	The AC drive operates (motor is running)
3	General fault	A fault trip has occurred
4	General fault inverted	A fault trip has not occurred
5	General alarm	An alarm has been initiated
6	Reversed	The reverse command has been given
7	At speed	The output frequency has reached the set frequency reference
8	Thermistor fault	A thermistor fault has occurred.
9	Motor regulator activated	One of the limit regulators (e.g. current limit, torque limit) is activated
10	Start signal active	Drive start command is active.
11	Keypad control active	Keypad control selected (active control place is keypad).
12	I/O control B active	I/O control place B selected (active control place is I/O B)
13	Limit supervision 1	Activates if the signal value falls below or exceeds the set supervision limit (P3.8.3 or P3.8.7) depending on the selected function.
14	Limit supervision 2	
15	Fire Mode active	Fire Mode function is active.
16	Flushing active	Flushing function is active.
17	Preset Frequency active	The preset frequency has been selected with digital input signals.
18	Quick Stop active	Quick Stop function has been activated.
19	PID in Sleep mode	PID-controller is in Sleep mode.
20	PID Soft Fill activated	PID-controller Soft Fill function is activated.
21	PID feedback supervision	PID-controller feedback value is beyond the supervision limits.
22	ExtPID feedback supervision	External PID-controller feedback value is beyond the supervision limits.
23	Input pressure alarm	The input pressure signal value of the pump has fallen below the value defined with parameter P3.13.9.7.
24	Frost protection alarm	The pump's measured temperature has fallen below the level defined with parameter P3.13.10.5.
25	Time channel 1	Status of Time channel 1
26	Time channel 2	Status of Time channel 2
27	Time channel 3	Status of Time channel 3
28	Fieldbus Control Word bit 13	Digital (relay) output control from Fieldbus control word bit 13.
29	Fieldbus Control Word bit 14	Digital (relay) output control from Fieldbus control word bit 14.

Table 125. Output signals via RO1

Selection	Selection name	Description
30	Fieldbus Control Word bit 15	Digital (relay) output control from Fieldbus control word bit 15.
31	Fieldbus Process Data In1 bit 0	Digital (relay) output control from Fieldbus Process Data In1, bit 0.
32	Fieldbus Process Data In1 bit 1	Digital (relay) output control from Fieldbus Process Data In1, bit 1.
33	Fieldbus Process Data In1 bit 2	Digital (relay) output control from Fieldbus Process Data In1, bit 2.
34	Maintenance counter 1 alarm	Maintenance counter has reached the alarm limit defined with parameter P3.16.2.
35	Maintenance Counter 1 Fault	Maintenance counter has reached the alarm limit defined with parameter P3.16.3.
36	Block 1 Out	Output of programmable Block 1. See parameter menu M3.19 Block Programming.
37	Block 2 Out	Output of programmable Block 2. See parameter menu M3.19 Block Programming.
38	Block 3 Out	Output of programmable Block 3. See parameter menu M3.19 Block Programming.
39	Block 4 Out	Output of programmable Block 4. See parameter menu M3.19 Block Programming.
40	Block 5 Out	Output of programmable Block 5. See parameter menu M3.19 Block Programming.
41	Block 6 Out	Output of programmable Block 6. See parameter menu M3.19 Block Programming.
42	Block 7 Out	Output of programmable Block 7. See parameter menu M3.19 Block Programming.
43	Block 8 Out	Output of programmable Block 8. See parameter menu M3.19 Block Programming.
44	Block 9 Out	Output of programmable Block 9. See parameter menu M3.19 Block Programming.
45	Block 10 Out	Output of programmable Block 10. See parameter menu M3.19 Block Programming.
46	Jockey pump control	Control signal for external jockey pump. See chapter 8.7.33.2.
47	Priming pump control	Control signal for external priming pump. See chapter 8.7.33.3.
48	Auto-cleaning active	Pump auto-cleaning function is activated.
49	Multipump K1 control	Contact control for <i>Multipump</i> function
50	Multipump K2 control	Contact control for <i>Multipump</i> function
51	Multipump K3 control	Contact control for <i>Multipump</i> function
52	Multipump K4 control	Contact control for <i>Multipump</i> function
53	Multipump K5 control	Contact control for <i>Multipump</i> function
54	Multipump K6 control	Contact control for <i>Multipump</i> function
55	Multipump K7 control	Contact control for <i>Multipump</i> function
56	Multipump K8 control	Contact control for <i>Multipump</i> function

8.5.6 ANALOGUE OUTPUTS

P3.5.4.1.1 AO1 FUNCTION (ID 10050)

This parameter defines the content of the analogue output signal 1. The scaling of the analogue output signal depends on the selected signal. See Table 126. below.

Table 126. AO1 signal scaling

Selection	Selection name	Description
0	Test 0% (Not used)	Analogue output is forced either to 0% or 20% depending on parameter P3.5.4.1.3.
1	TEST 100%	Analogue output is forced to 100% signal (10V / 20mA).
2	Output frequency	Actual output frequency from zero to Maximum frequency reference.
3	Frequency reference	Actual frequency reference from zero to Maximum frequency reference.
4	Motor speed	Actual motor speed from zero to Motor nominal speed.
5	Output current	Drive output current from zero to Motor nominal current.
6	Motor torque	Actual motor torque from zero to motor nominal torque (100%).
7	Motor power	Actual motor power from zero to Motor nominal power (100%).
8	Motor voltage	Actual motor voltage from zero to Motor nominal voltage.
9	DC-link voltage	Actual DC-link voltage 0...1000V.
10	PID Setpoint	PID Controller actual setpoint value (0...100%).
11	PID Feedback	PID Controller actual feedback value (0...100%).
12	PID output	PID controller output (0...100%).
13	ExtPID output	External PID controller output (0...100%).
14	Fieldbus Process Data In 1	Fieldbus Process Data In 1 from 0...10000 (corresponding 0...100.00%).
15	Fieldbus Process Data In 2	Fieldbus Process Data In 2 from 0...10000 (corresponding 0...100.00%).
16	Fieldbus Process Data In 3	Fieldbus Process Data In 3 from 0...10000 (corresponding 0...100.00%).
17	Fieldbus Process Data In 4	Fieldbus Process Data In 4 from 0...10000 (corresponding 0...100.00%).
18	Fieldbus Process Data In 5	Fieldbus Process Data In 5 from 0...10000 (corresponding 0...100.00%).
19	Fieldbus Process Data In 6	Fieldbus Process Data In 6 from 0...10000 (corresponding 0...100.00%).
20	Fieldbus Process Data In 7	Fieldbus Process Data In 7 from 0...10000 (corresponding 0...100.00%).
21	Fieldbus Process Data In 8	Fieldbus Process Data In 8 from 0...10000 (corresponding 0...100.00%).
22	Block 1 Out	Output of programmable Block 1 from 0...10000 (corresponding 0...100,00%). See parameter menu M3.19 Block Programming.

Table 126. AO1 signal scaling

Selection	Selection name	Description
23	Block 2 Out	Output of programmable Block 2 from 0...10000 (corresponding 0...100,00%). See parameter menu M3.19 Block Programming.
24	Block 3 Out	Output of programmable Block 3 from 0...10000 (corresponding 0...100,00%). See parameter menu M3.19 Block Programming.
25	Block 4 Out	Output of programmable Block 4 from 0...10000 (corresponding 0...100,00%). See parameter menu M3.19 Block Programming.
26	Block 5 Out	Output of programmable Block 5 from 0...10000 (corresponding 0...100,00%). See parameter menu M3.19 Block Programming.
27	Block 6 Out	Output of programmable Block 6 from 0...10000 (corresponding 0...100,00%). See parameter menu M3.19 Block Programming.
28	Block 7 Out	Output of programmable Block 7 from 0...10000 (corresponding 0...100,00%). See parameter menu M3.19 Block Programming.
29	Block 8 Out	Output of programmable Block 8 from 0...10000 (corresponding 0...100,00%). See parameter menu M3.19 Block Programming.
30	Block 9 Out	Output of programmable Block 9 from 0...10000 (corresponding 0...100,00%). See parameter menu M3.19 Block Programming.
31	Block 10 Out	Output of programmable Block 10 from 0...10000 (corresponding 0...100,00%). See parameter menu M3.19 Block Programming.

P3.5.4.1.4 AO1 MINIMUM SCALE (ID 10053)**P3.5.4.1.5 AO1 MAXIMUM SCALE (ID 10054)**

These parameters can be used to freely adjust the analogue output signal scaling. The scale is defined in process units and it depends on the selection of parameter P3.5.4.1.1.

Example: The drive's output frequency is selected for the content of the analogue output signal and parameters P3.5.4.1.4 and P3.5.4.1.5 are set to 10...40 Hz.

When the drive's output frequency changes between 10 and 40 Hz the analogue output signal changes between 0...20 mA.

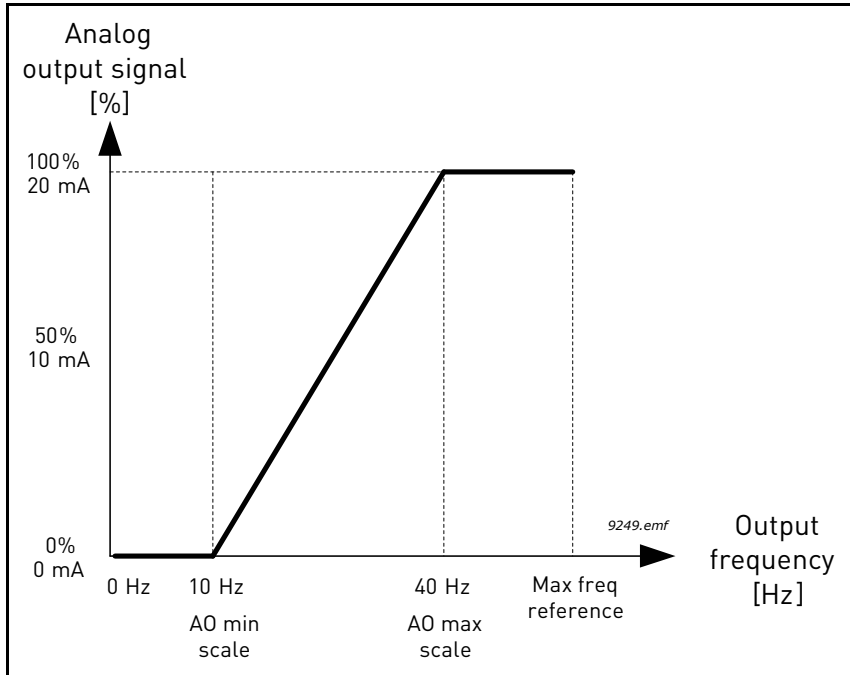

Figure 71. AO1 signal scaling

8.6 PROHIBIT FREQUENCIES

In some systems it may be necessary to avoid certain frequencies due to mechanical resonance problems. By setting up prohibit frequencies, it is possible to skip these ranges. When the (input) frequency reference is increased, the internal frequency reference is kept at the low limit until the (input) reference is above the high limit.

P3.7.1 PROHIBIT FREQUENCY RANGE 1 LOW LIMIT (ID 509)

P3.7.2 PROHIBIT FREQUENCY RANGE 1 HIGH LIMIT (ID 510)

P3.7.3 PROHIBIT FREQUENCY RANGE 2 LOW LIMIT (ID 511)

P3.7.4 PROHIBIT FREQUENCY RANGE 2 HIGH LIMIT (ID 512)

P3.7.5 PROHIBIT FREQUENCY RANGE 3 LOW LIMIT (ID 513)

P3.7.6 PROHIBIT FREQUENCY RANGE 3 HIGH LIMIT (ID 514)

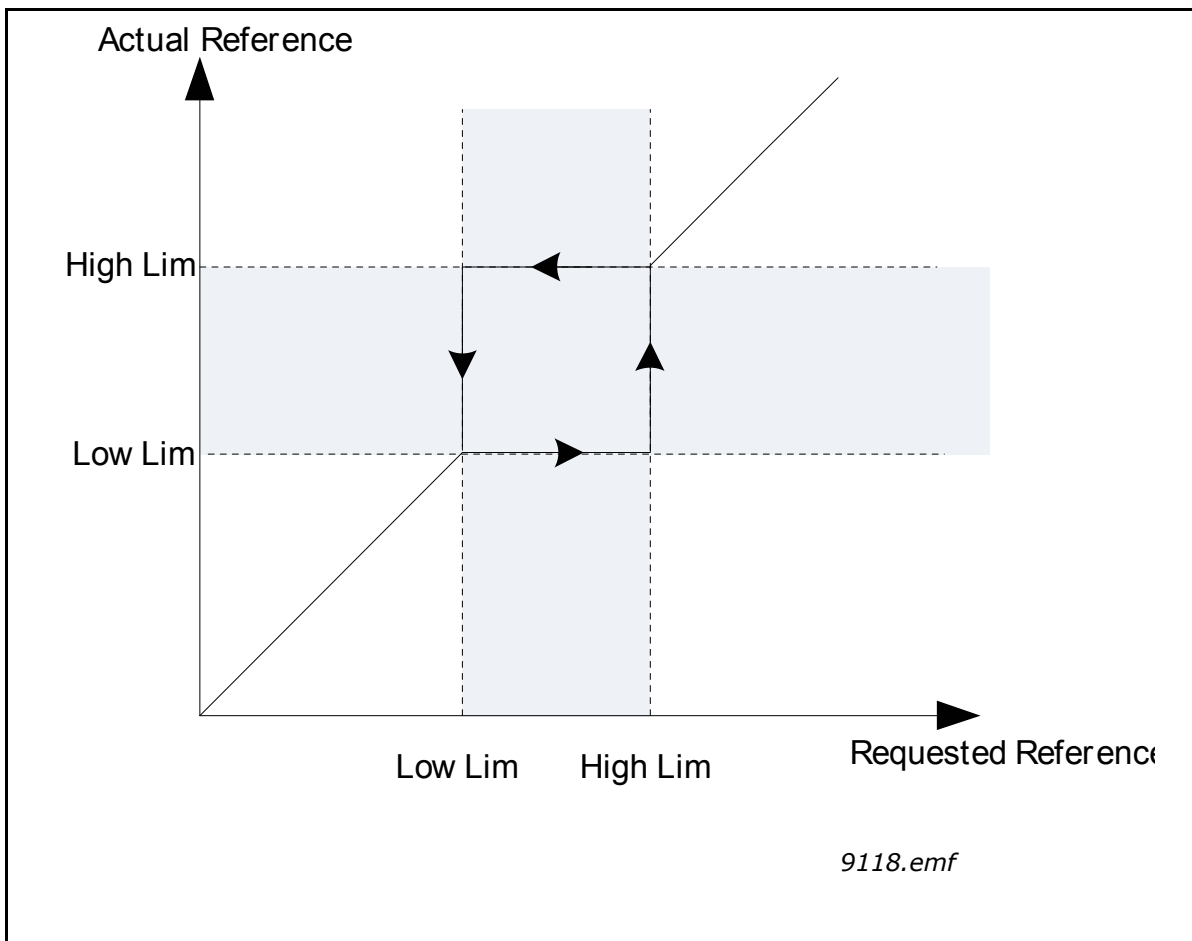

Figure 72. Prohibited frequencies

P3.7.7 RAMP TIME FACTOR (ID 518)

The *Ramp time factor* defines the acceleration/deceleration time when the output frequency is in a prohibited frequency range. The *Ramp time factor* is multiplied with the value of parameters P3.4.1.2/P3.4.1.3 (*Ramp acceleration/deceleration time*). For example the value 0.1 makes the acceleration/deceleration time ten times shorter.

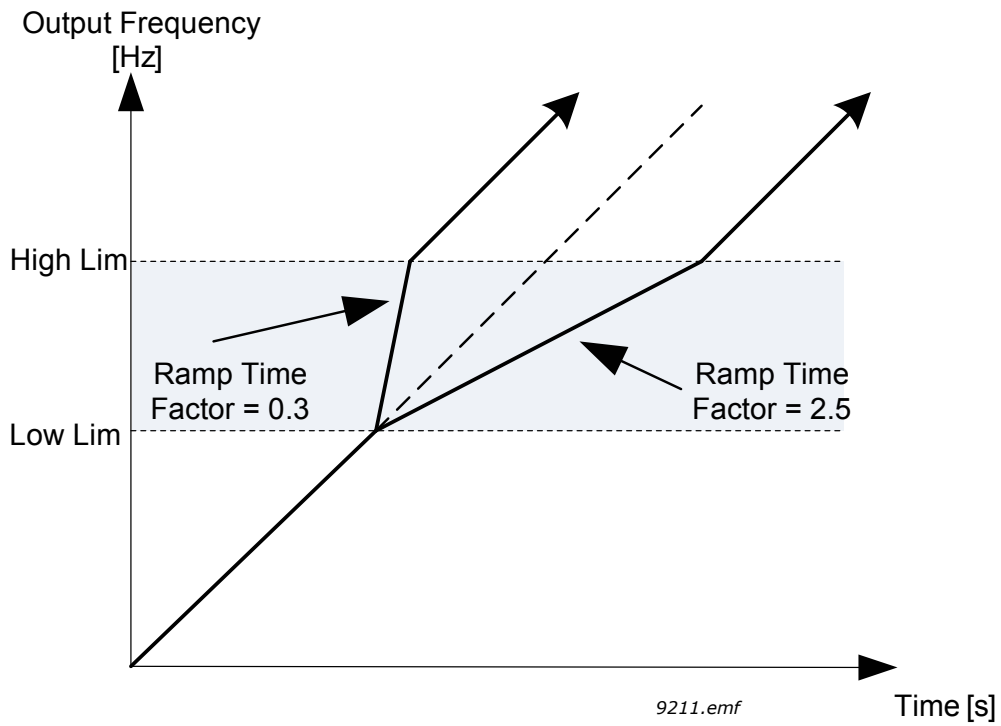

Figure 73. Ramp time factor

8.7 SUPERVISIONS

P3.9.1.2 **RESPONSE TO EXTERNAL FAULT (ID 701)**

An alarm message or a fault action and message is generated by an external fault external fault signal in one of the programmable digital inputs (DI3 by default) using parameters P3.5.1.11 and P3.5.1.12. The information can also be programmed into any of the relay outputs.

8.7.1 **MOTOR THERMAL PROTECTIONS**

The motor thermal protection is to protect the motor from overheating. The AC drive is capable of supplying higher than nominal current to the motor. If the load requires this high current, there is a risk that the motor will be thermally overloaded. This is the case especially at low frequencies. At low frequencies the cooling effect of the motor is reduced as well as its capacity. If the motor is equipped with an external fan the load reduction at low speeds is small.

The motor thermal protection is based on a calculated model and it uses the output current of the drive to determine the load on the motor.

The motor thermal protection can be adjusted with parameters, which are presented below.

The thermal stage of the motor can be monitored on the control keypad display. See chapter 2 User interfaces on Vacon®100 FLOW .

NOTE! If you use long motor cables (max. 100m) together with small drives (≤1.5 kW), the motor current measured by the drive can be much higher than the actual motor current due to capacitive currents in the motor cable. Consider this when setting up the motor thermal protection functions.



CAUTION! The calculated model does not protect the motor, if the airflow to the motor is reduced by a blocked air-intake grill. The model starts from zero, if the control board is powered off.

P3.9.2.3 **ZERO SPEED COOLING FACTOR (ID 706)**

Defines the cooling factor at zero speed in relation to the point, where the motor is running at nominal speed without external cooling. See Figure 74. below.

The default value is set assuming that there is no external fan cooling the motor. If an external fan is used, this parameter can be set to 90% (or even higher).

If you change the parameter P3.1.1.4 (*Motor nominal current*), this parameter is automatically restored to the default value.

Setting this parameter does not affect the maximum output current of the drive, which is determined by parameter P3.1.3.1 alone.

The corner frequency for the thermal protection is 70% of the motor nominal frequency (P3.1.1.2).

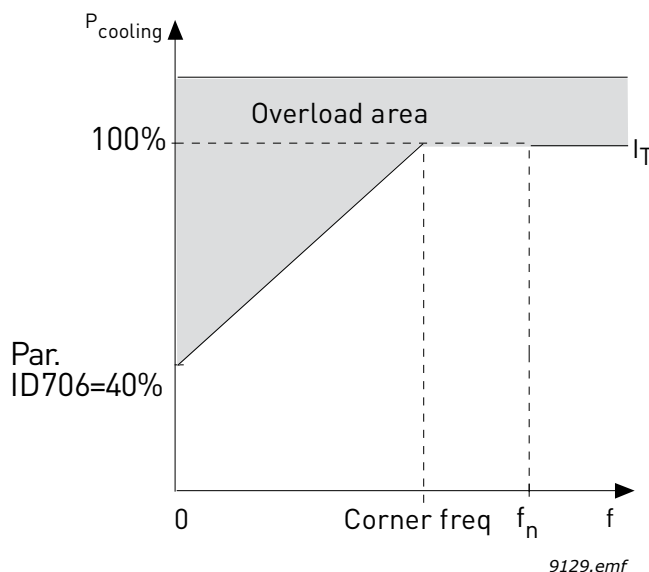

Figure 74. Motor thermal current I_T curve, ID 706 = P3.9.2.3 Zero speed cooling factor

P3.9.2.4 MOTOR THERMAL TIME CONSTANT (ID 707)

This is the thermal time constant of the motor. The bigger the motor, the bigger the time constant. The time constant is the time, within which the calculated thermal stage has reached 63% of its final value.

The motor thermal time is specific to the motor design and it varies between different motor manufacturers. The default value of the parameter varies from size to size.

If the motor's t_6 -time (t_6 is the time in seconds the motor can safely operate at six times the rated current) is known (given by the motor manufacturer), the time constant parameter can be set basing on it. As a rule of thumb, the motor thermal time constant in minutes equals to $2 \cdot t_6$. If the drive is in stop stage, the time constant is internally increased to three times the set parameter value. The cooling in stop stage is based on convection and the time constant is increased.

See Figure 76. below.

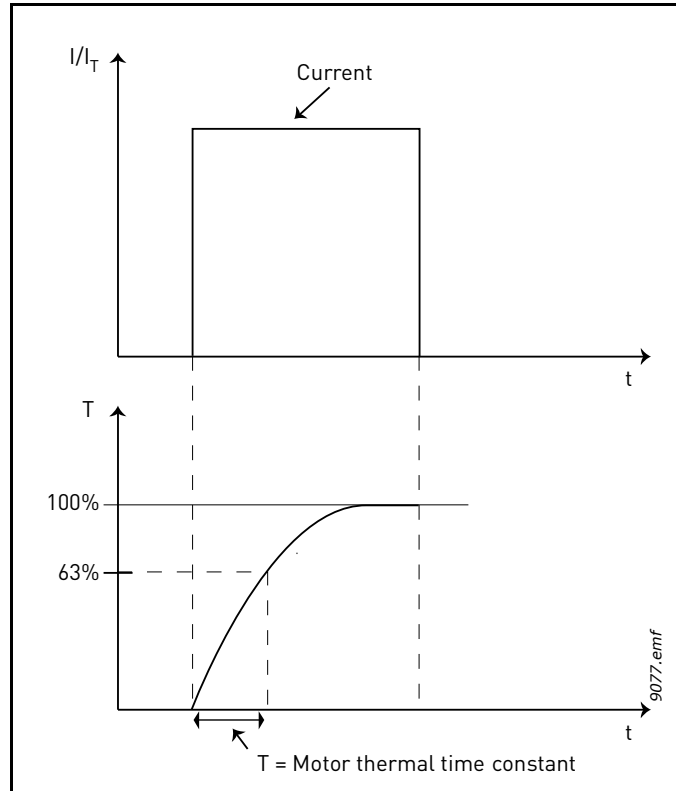

Figure 75. Motor thermal time constant

P3.9.2.5 MOTOR THERMAL LOADABILITY (ID 708)

Setting value to 130% means that the nominal temperature will be reached with 130% of motor nominal current.

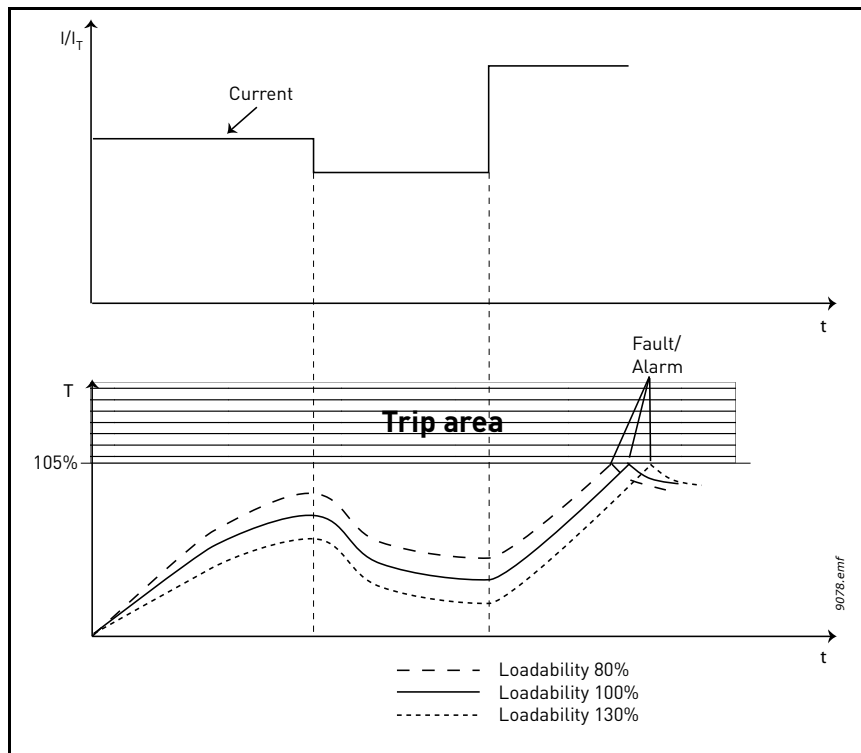

Figure 76. Motor temperature calculation

8.7.2 MOTOR STALL PROTECTION

The motor stall protection protects the motor from short time overload situations such as one caused by a stalled shaft. The reaction time of the stall protection can be set shorter than that of motor thermal protection. The stall state is defined with two parameters, P3.9.3.2 (*Stall current*) and P3.9.3.4 (*Stall frequency limit*). If the current is higher than the set limit and the output frequency is lower than the set limit the stall state is true. There is actually no real indication of the shaft rotation. Stall protection is a type of overcurrent protection.

NOTE! If you use long motor cables (max. 100m) together with small drives (≤1.5 kW), the motor current measured by the drive can be much higher than the actual motor current due to capacitive currents in the motor cable. Consider this when setting up the stall protection functions.

P3.9.3.2 STALL CURRENT (ID 710)

The current can be set to 0.0...2*IL. For a stall stage to occur, the current must have exceeded this limit. If parameter P3.1.3.1 *Motor current limit* is changed, this parameter is automatically calculated to 90% of the current limit.

NOTE! In order to guarantee desired operation, this limit must be set below the current limit.

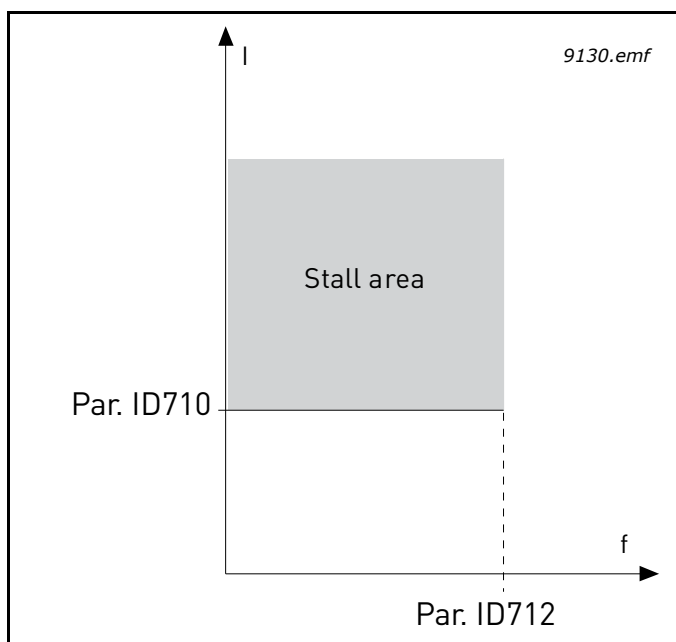

Figure 77. Stall characteristics settings, ID 710 = P3.9.3.2 Stall current, ID 712 = P3.9.3.4 Stall frequency limit

P3.9.3.3 STALL TIME LIMIT (ID 711)

This time can be set between 1.0 and 120.0 s.

This is the maximum time allowed for a stall stage. The stall time is counted by an internal up/down counter.

If the stall time counter value goes above this limit the protection will cause a trip (see P3.9.3.1).

8.7.3 UNDERLOAD (DRY PUMP) PROTECTION

The purpose of the motor underload protection is to make sure that there is load on the motor when the drive is running. If the motor loses its load there might be a problem in the process, e.g. a broken belt or a dry pump.

Motor underload protection can be adjusted by setting the underload curve with parameters P3.9.4.2 (*Underload protection: Field weakening area load*) and P3.9.4.3 (*Zero frequency load*). The underload curve is a squared curve set between the zero frequency and the field weakening point. The protection is not active below 5 Hz (the underload time counter is stopped).

The torque values for setting the underload curve are set in percentage which refers to the nominal torque of the motor. The motor's name plate data, parameter motor nominal current and the drive's nominal current IH are used to find the scaling ratio for the internal torque value. If other than nominal motor is used with the drive, the accuracy of the torque calculation decreases.

NOTE! If you use long motor cables (max. 100m) together with small drives (≤ 1.5 kW), the motor current measured by the drive can be much higher than the actual motor current due to capacitive currents in the motor cable. Consider this when setting up the stall protection functions.

P3.9.4.2 UNDERLOAD PROTECTION: FIELD WEAKENING AREA LOAD (ID 714)

The torque limit can be set between 10.0-150.0 % $\times T_{nMotor}$.

This parameter gives the value for the minimum torque allowed when the output frequency is above the field weakening point.

If you change parameter P3.1.1.4 (*Motor nominal current*) this parameter is automatically restored to the default value.

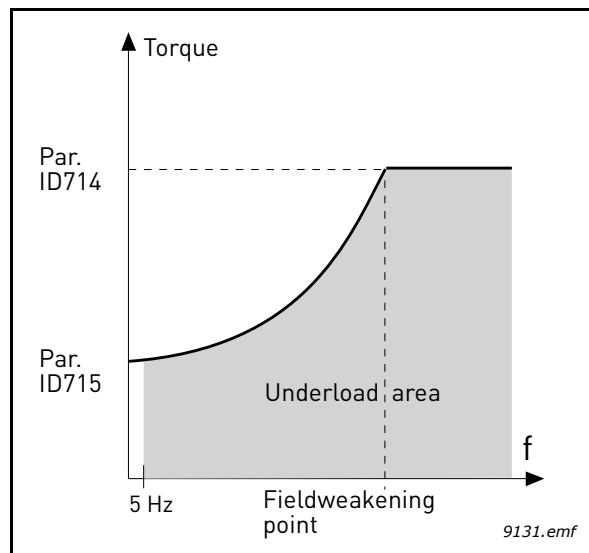

Figure 78. Setting of minimum load, ID 714 = P3.9.4.2 Underload protection: Field weakening area load, ID 715 = P3.9.4.3 Underload protection: Zero frequency load

P3.9.4.4 UNDERLOAD PROTECTION: TIME LIMIT (ID 716)

This time can be set between 2.0 and 600.0 s.

This is the maximum time allowed for an underload state to exist. An internal up/down counter counts the accumulated underload time. If the underload counter value goes above this limit, the protection will cause a trip according to parameter P3.9.4.1). If the drive is stopped the underload counter is reset to zero. See Figure 79. below.

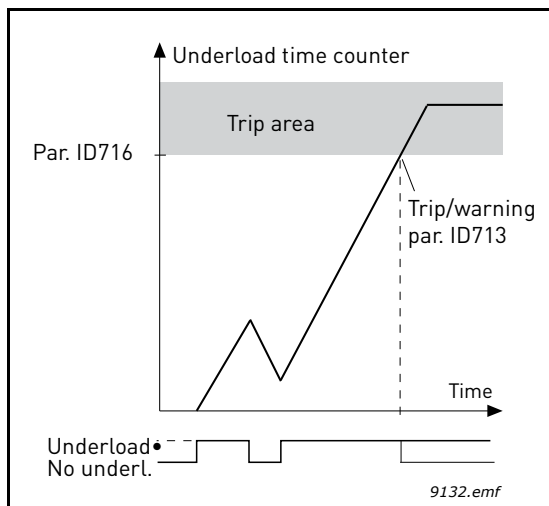

Figure 79. Underload time counter function, ID 713 = P3.9.4.1 Underload fault, ID 716 = P3.9.4.4 Underload protection:Time limit

P3.9.5.1 QUICK STOP MODE (ID 1276)

P3.5.1.26 QUICK STOP ACTIVATION (ID 1213)

P3.9.5.3 QUICK STOP DECELERATION TIME (ID 1256)

P3.9.5.4 RESPONSE TO QUICK STOP FAULT (ID 744)

The *Quick stop* function is a way to stop the drive in an exceptional manner from I/O or Fieldbus in an exceptional situation. The drive can be made to decelerate and stop according to a separately defined method when the *Quick stop* is activated. An alarm or fault response can also be set to leave a mark that a quick stop has been requested in the fault history, if a reset is required for restart.

NOTE! *Quick stop* is not an emergency stop or safety function! It is advised that an emergency stop physically cuts the power supply to the motor.

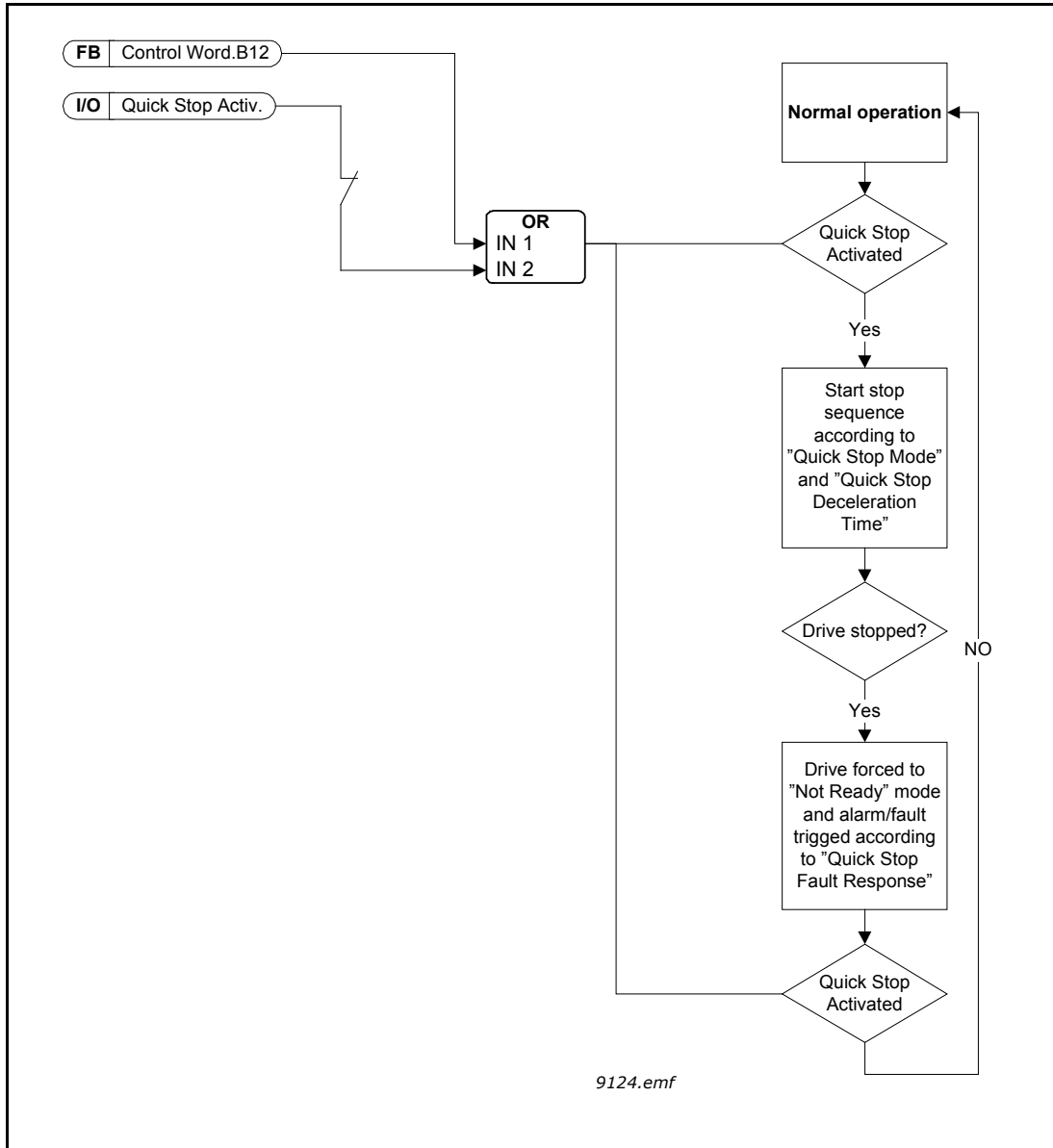

Figure 80. Quick stop logic

P3.9.8.1 ANALOGUE INPUT LOW PROTECTION (ID 767)

This parameter defines if the AI Low Protection is used or not.

AI Low protection is used to detect analogue input signal failures, if the input signal used as frequency reference or torque reference, or PID/ExtPID controllers are configured to use analogue input signals.

The user can select, whether the protection is enabled only when the drive is in Run state or respectively in both Run and Stop states. Response for the AI Low Fault can be selected by parameter P3.9.8.2 AI Low Fault.

Table 127. AI low protection settings

Selection number	Selection name	Description
1	Protection disabled	
2	Protection enabled in Run state	The protection is enabled only when the drive is in run state
3	Protection enabled in Run and Stop	Protection is enabled in both, run and stop states

P3.9.8.2 ANALOGUE INPUT LOW FAULT (ID 700)

This parameter defines the response for F50 - AI Low Fault (Fault ID: 1050) if AI Low Protection is enabled by parameter 3.9.8.1.

AI Low protection monitors the signal level of analogue inputs 1-6. AI Low fault or alarm is generated, if parameter P3.9.8.1 AI Low Protection is Enabled and analogue input signal falls below 50 % of the defined minimum signal range for 3 seconds.

Table 128.

Selection number	Selection name	Description
1	Alarm	
2	Alarm	P3.9.1.13 is set to frequency reference
3	Alarm	The last valid frequency is kept as frequency reference
4	Fault	Stop according to Stop mode P3.2.5
5	Fault	Stop by coasting

NOTE! AI Low Fault response 3 (Alarm + Previous Freq) can be used only, if analogue input 1 or analogue input 2 is used as frequency reference.

8.8 AUTOMATIC RESET

P3.10.1 AUTOMATIC RESET (ID 731)

Activate the *Automatic reset* after fault with this parameter.

NOTE! Automatic reset is allowed for certain faults only. By giving the parameters P3.10.6 to P3.10.13 the value **0** or **1** you can either allow or deny the automatic reset after the respective faults.

P3.10.3 WAIT TIME (ID 717)

P3.10.4 AUTOMATIC RESET: TRIAL TIME (ID 718)

P3.10.5 NUMBER OF TRIALS (ID 759)

The Automatic reset function keeps resetting the faults that appear during the time set with this parameter. If the number of faults during the trial time exceed the value of parameter P3.10.5, a permanent fault is generated. Otherwise the fault is cleared after the trial time has elapsed and the the next fault starts the trial time count again.

Parameter P3.10.5 determines the maximum number of automatic fault reset attempts during the trial time set by this parameter. The time count starts from the first autoreset. The maximum number is independent of the fault type.

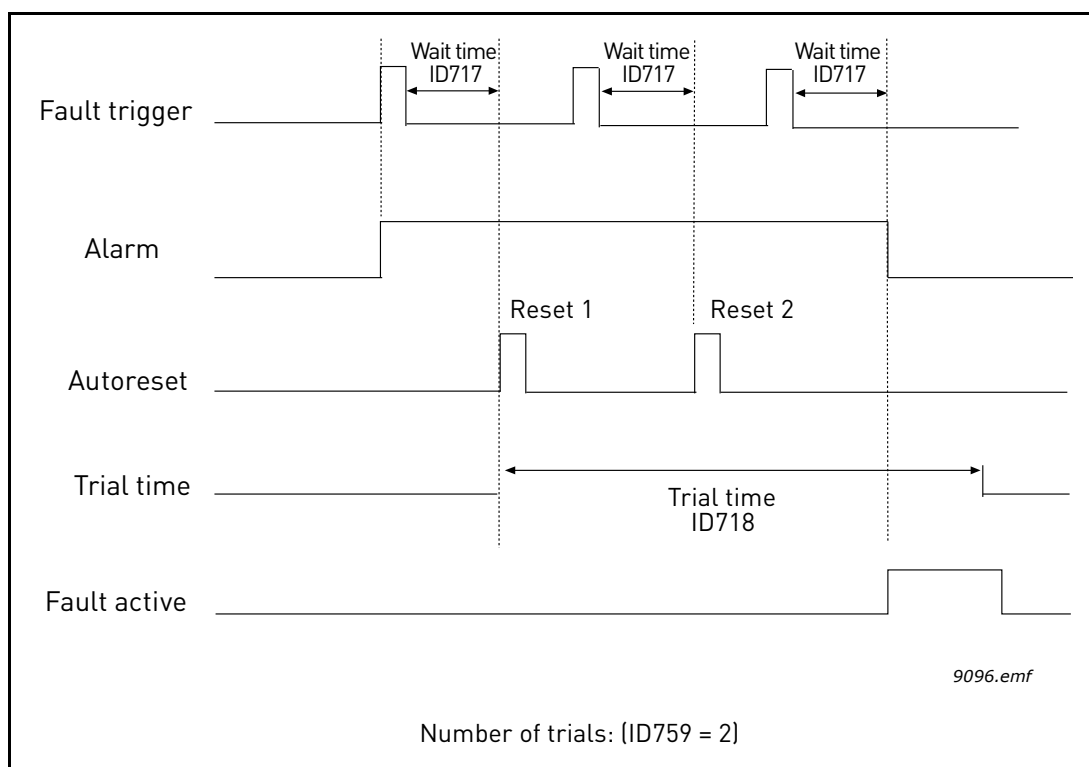

Figure 81. Automatic reset function, ID = 717 P3.10.3 Wait time, P3.10.4 Trial time, ID 759 = P3.10.5 Number of trials

8.9 TIMER FUNCTIONS

The time functions (Time Channels) in the Vacon® 100 give you the possibility to program functions to be controlled by the internal RTC (Real Time Clock). Practically every function that can be controlled by a digital input can also be controlled by a Time Channel. Instead of having an external PLC controlling a digital input you can programme the "closed" and "opened" intervals of the input internally.

NOTE! The functions of this parameter group can be made the fullest advantage of only if the battery (option) has been installed and the Real Time Clock settings have been properly made during the Startup Wizard (see 2 and page 3). **It is not recommended** to use these function without battery backup because the drive's time and date settings will be reset at every power down, if no battery for the RTC is installed.

Time channels

The on/off logic for the *Time channels* is configured by assigning *Intervals* and/or *Timers* to them. One *Time channel* can be controlled by many *Intervals* or *Timers* by assigning as many of these as needed to the *Time channel*.

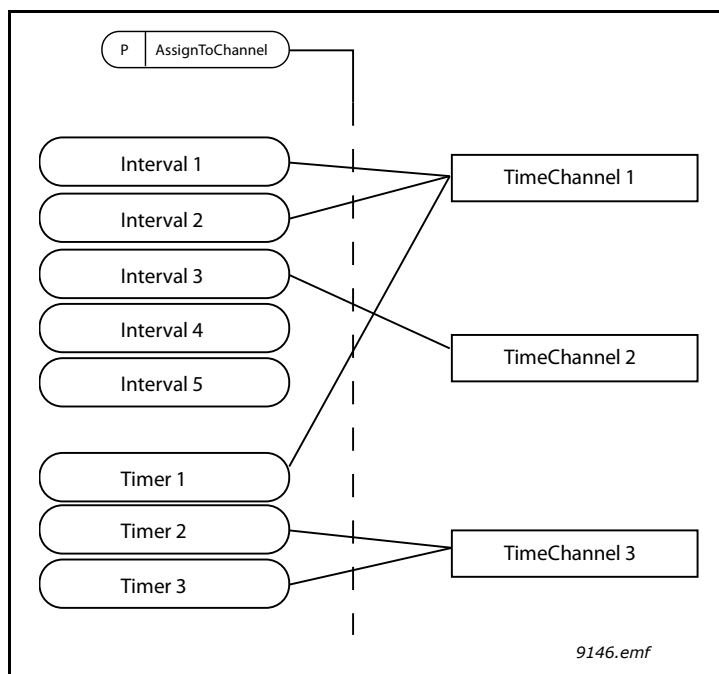

Figure 82. The intervals and timers can be assigned to time channels in a flexible way. Every interval and timer has its own parameter for assigning to a time channel.

Intervals

Every interval is given an "ON Time" and "OFF Time" with parameters. This is the daily time that the interval will be active during the days set with "From Day" and "To Day" parameters. E.g. the parameter setting below means that the interval is active from 7 am to 9 am every weekday (Monday to Friday). The Time Channel to which this Interval is assigned will be seen as a closed "virtual digital input" during that period.

- ON Time:** 07:00:00
- OFF Time:** 09:00:00
- From Day:** Monday
- To Day:** Friday

Timers

Timers can be used to set the active Time Channel during a certain time by a command from a digital input (or a Time Channel).

The below parameters will set the Timer active when Digital Input 1 on Slot A is closed and keep it active for 30 s after it is opened.

Duration: 30 s

Timer: Dign SlotA.1

Tip! A duration of 0 seconds can be used for simply overriding a Time channel activated from a digital input without any off delay after the falling edge.

EXAMPLE

Problem:

We have an AC drive for air conditioning in a warehouse. It needs to run between 7am - 5pm on weekdays and 9am - 1pm on weekends. Additionally, we need to be able to manually force the drive to run outside working hours, if there are people in the building and to leave it running for 30 min afterwards.

Solution:

We need to set up two intervals, one for weekdays and one for weekends. A Timer is also needed for activation outside the office hours. An example of configuration below.

Interval 1:

P3.12.1.1: *ON Time:* **07:00:00**

P3.12.1.2: *OFF Time:* **17:00:00**

P3.12.1.3: *Days:* **Monday, Tuesday, Wednesday, Thursday, Friday**

P3.12.1.4: *Assign to channel:* **Time channel 1**

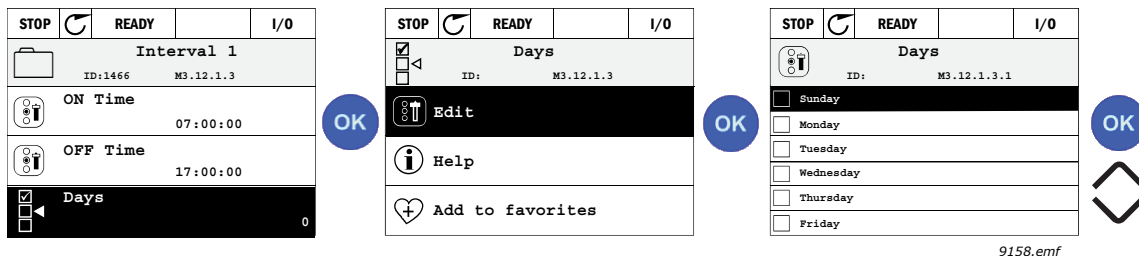

Figure 83.

Interval 2:

P3.12.2.1: *ON Time:* **09:00:00**

P3.12.2.2: *OFF Time:* **13:00:00**

P3.12.2.3: *Days:* **Saturday, Sunday**

P3.12.2.4: *AssignToChannel:* **Time channel 1**

Timer 1

The manual bypassing can be handled by a digital input 1 on slot A (by a different switch or connection to lighting).

P3.12.6.1: *Duration:* **1800 s** (30 min)

P3.12.6.3: *Assign to channel:* **Time channel 1**

P3.12.6.2: *Timer 1:* **Dign SlotA.1** (Parameter located in digital inputs menu.)

Finally select the Channel 1 for the I/O Run command.

P3.5.1.1: *Control signal 1 A: Time Channel 1*

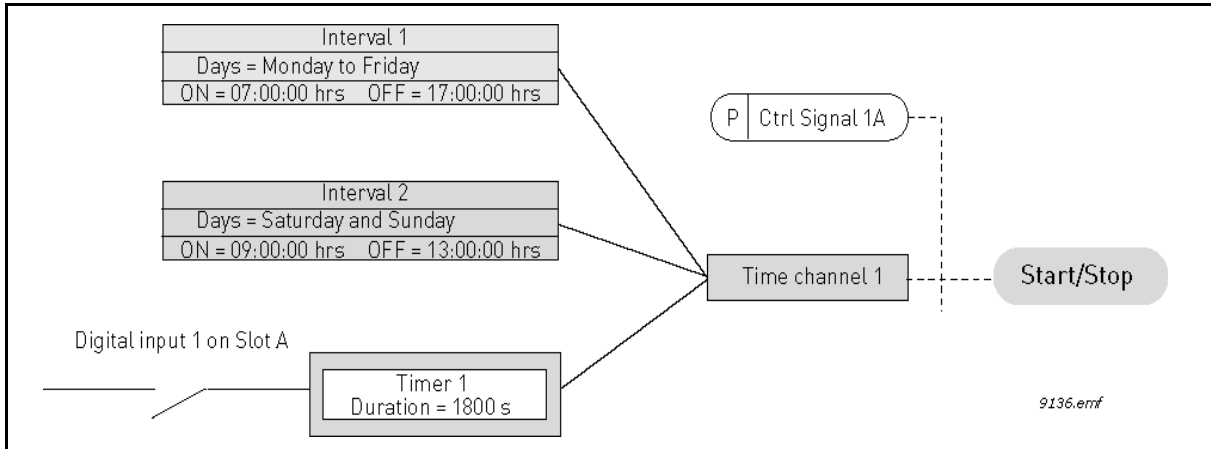

Figure 84. Final configuration, where Time channel 1 is used as control signal for start command instead of a digital input.

8.10 PID CONTROLLER 1

P3.13.1.9 DEAD BAND (ID 1056)

P3.13.1.10 DEAD BAND DELAY (ID 1057)

The PID controller output is locked, if the actual value stays within the deadband area around the reference for a predefined time. This function will prevent unnecessary movement and wear on actuators, e.g. valves.

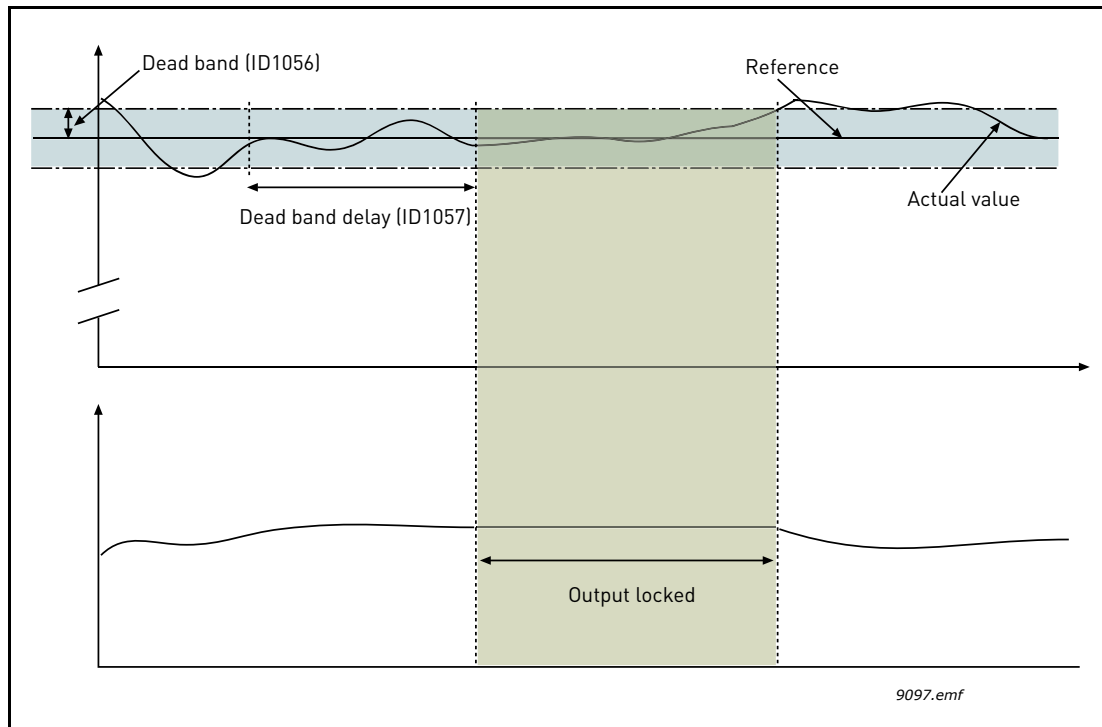

Figure 85. Dead band

8.10.1 FEEDFORWARD

P3.13.4.1 FEEDFORWARD FUNCTION (ID 1059)

Feedforward usually needs accurate process models, but in some simple cases a gain + offset type of feedforward is enough. The feedforward part does not use any feedback measurements of the actual controlled process value (water level in the example 1 below). Vacon feedforward control uses other measurements which are indirectly affecting the controlled process value.

Example 1:

Controlling the water level of a tank by means of flow control. The desired water level has been defined as a setpoint and the actual level as feedback. The control signal acts on the incoming flow.

The outflow could be thought of as a disturbance that can be measured. Based on the measurements of the disturbance, we can try to compensate for this disturbance by simple feedforward control (gain and offset) which is added to the PID output.

This way the controller would react much faster to changes in the outflow than if you just had measured the level.

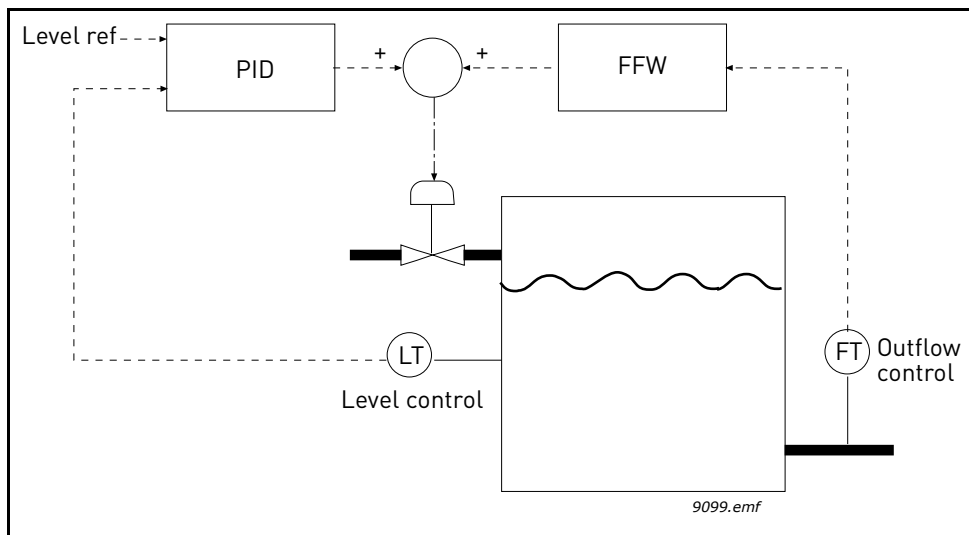

Figure 86. Feedforward control

8.10.2 SLEEP FUNCTION

This function will put the drive into sleep mode, if the frequency stays below the sleep limit for a longer time than that set with the Sleep Delay. This means that the start command remains on, but run request is turned off. When the actual value goes below or above the wake-up level depending on acting mode, the drive will activate run request again, if the start command is still on. Hence the drive wakes up.

P3.13.5.1 SLEEP FREQUENCY LIMIT 1 (ID 1016)

P3.13.5.2 SLEEP DELAY 1 (ID 1017)

P3.13.5.3 WAKE-UP LEVEL (ID 1018)

This function will put the drive into sleep mode, if the frequency stays below the sleep limit for a longer time than that set with the Sleep Delay (P3.13.5.2). This means that the start command remains on, but the run request is turned off. When the actual value goes below or above the wake-up level depending on the set acting mode, the drive will activate the run request again, if the start command is still on.

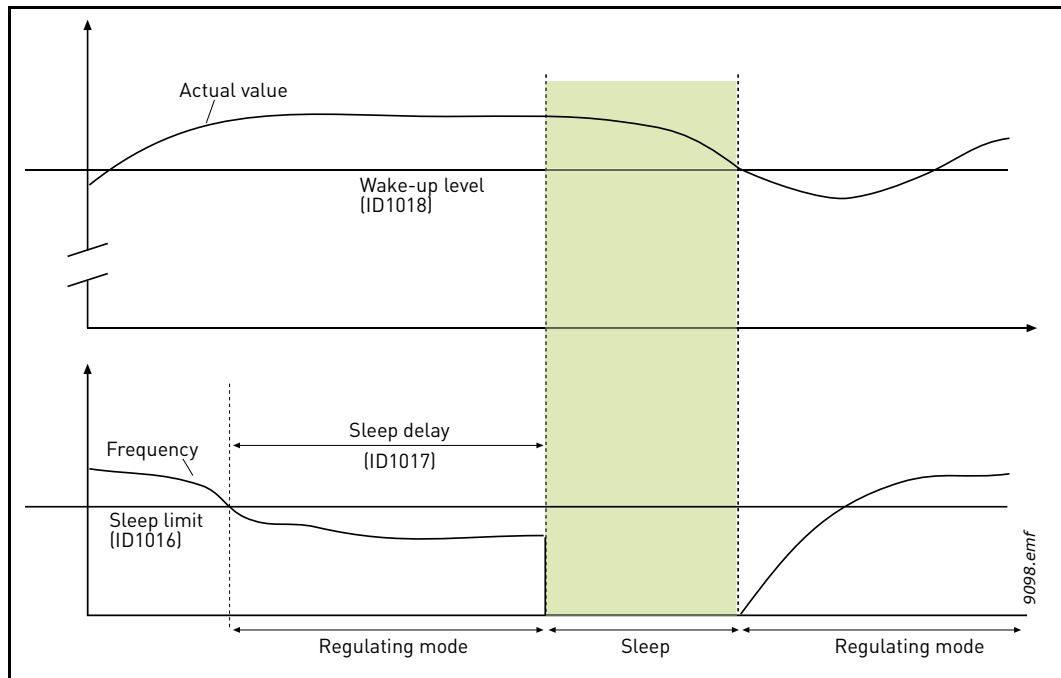

Figure 87. Sleep limit, Sleep delay, Wake-up level

P3.13.5.4 SP1 SLEEP BOOST (ID 1793)

P3.13.5.9 SP2 SLEEP BOOST (ID 1794)

Automatic increase of PID regulation setpoint before entering sleep state allows to build a higher process value and therefore maintain the sleep state longer, even with some moderate leakage.

Boost level is applied after the usual conditions to enter sleep state (frequency threshold and delay) are positively verified. After the increment in Setpoint has been reached by Actual, boost increment on Setpoint is cleared and the drive enters sleep state, stopping the motor.

The boost increment will be positive with direct PID regulation (P3.13.1.8 = Normal), and negative with reverse PID regulation (P3.13.1.8 = Inverted).

If the actual value does not reach the incremented setpoint, the boost value is anyway cleared after the time set with P3.13.5.5. In this case the drive returns to normal regulation with normal setpoint.

In a Multipump setup: if during boosting an auxiliary pump is started, boosting sequence is aborted and normal regulation is resumed.

8.10.3 FEEDBACK SUPERVISION

Feedback supervision is used to control that the *PID Feedback value* (process actual value) stays within predefined limits. With this function you can e.g. detect a major pipe burst and stop unnecessary flooding.

P3.13.6.1 ENABLE FEEDBACK SUPERVISION (ID 735)

These parameters define the range, within which the PID Feedback signal value is supposed to stay in a normal situation. If the PID Feedback signal goes above or below the defined supervision range for longer time than what is defined as the *Delay*, a PID Supervision fault (F101) will be triggered.

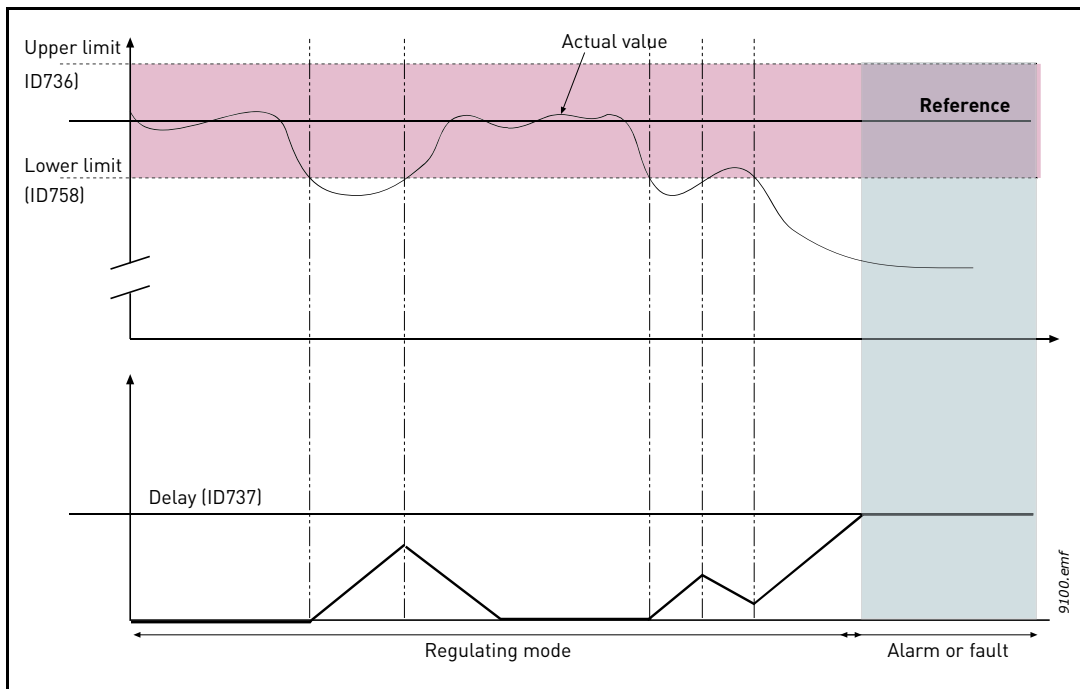

Figure 88. Feedback supervision

8.10.4 PRESSURE LOSS COMPENSATION

Upper and lower limits around the reference are set. When the actual value goes above or below the limit, a counter starts counting up towards the Delay (P3.13.6.4). When the actual value is within the allowed area, the same counter counts down instead. Whenever the counter is higher than the Delay, an alarm or fault (depending on the selected response with parameter P3.13.6.5) is generated.

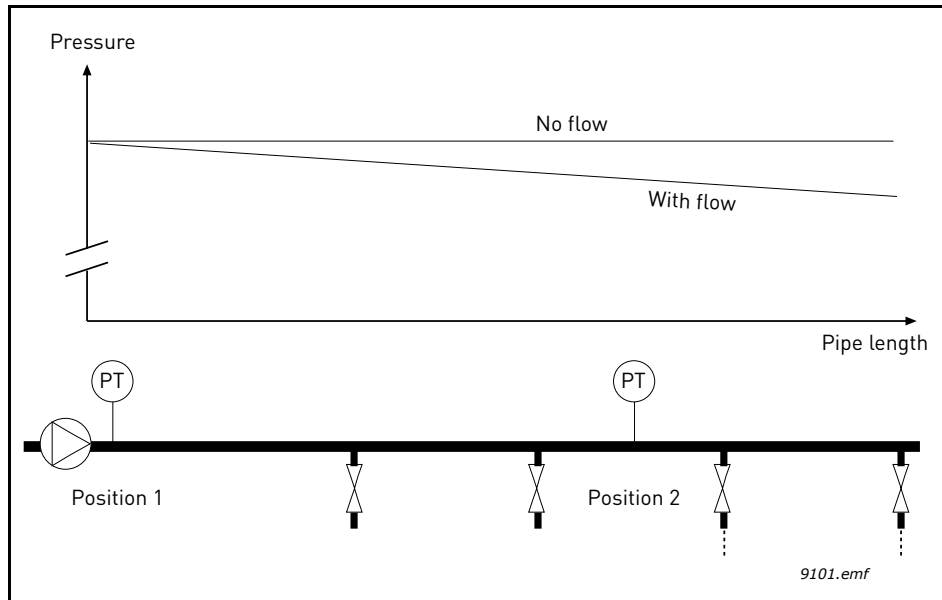

Figure 89. Position of pressure sensor (PT)

When pressurising a long pipe with many outlets, the best place for the sensor would probably be halfway down the pipe (Position 2). However, sensors might, for example, be placed directly after the pump. This will give the right pressure directly after the pump, but farther down in the pipe the pressure will drop depending on the flow.

P3.13.7.1 ENABLE SETPOINT 1 (ID 1189)

P3.13.7.2 SETPOINT 1 MAX COMPENSATION (ID 1190)

The sensor is placed in Position 1. The pressure in the pipe will remain constant when there is no flow. However, with flow, the pressure will drop farther down in the pipe. This can be compensated by raising the setpoint as the flow increases. In this case, the flow is estimated by the output frequency and the setpoint is linearly increased with the flow as in Figure 90. below.

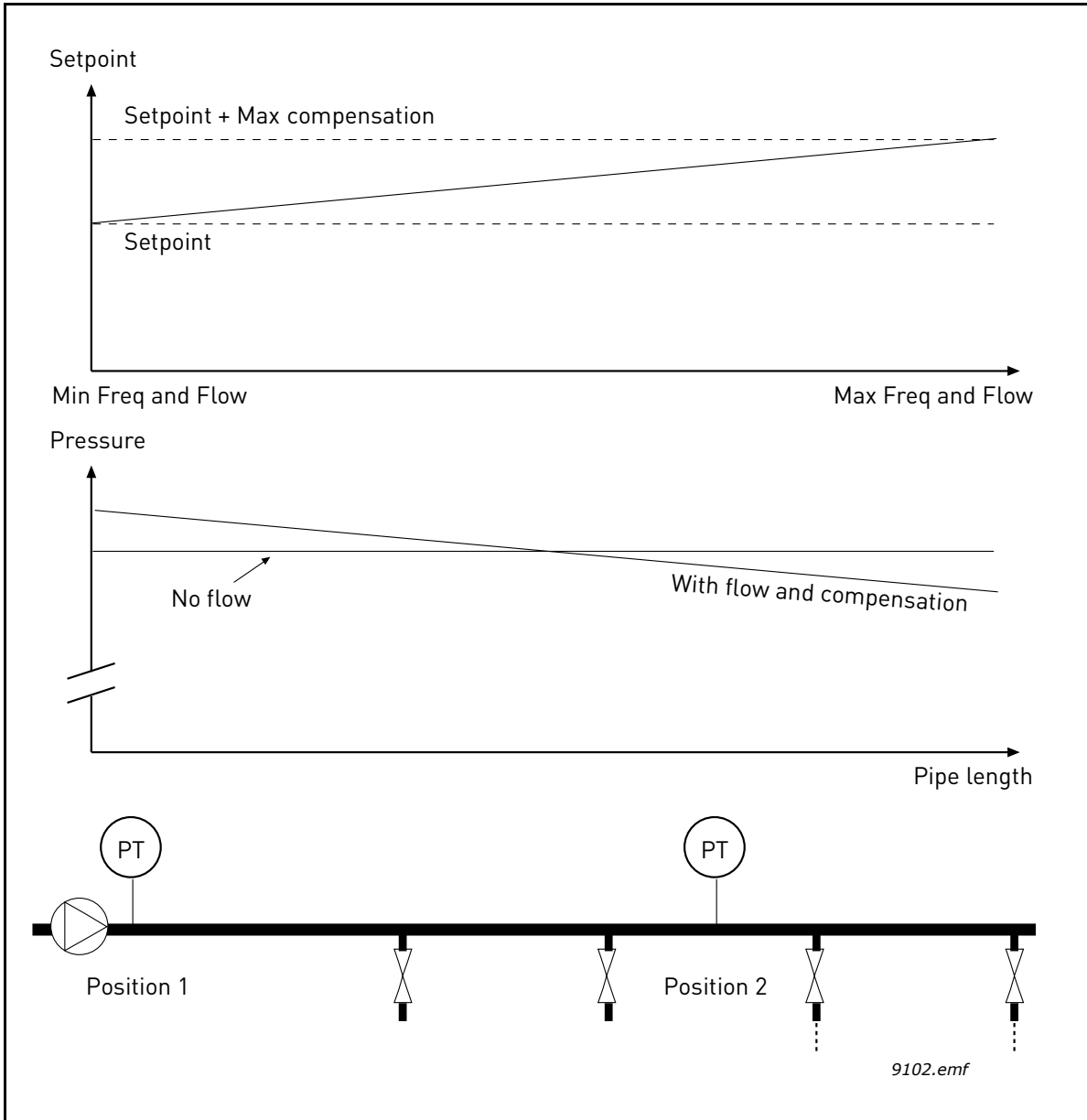

Figure 90. Enable setpoint 1 for pressure loss compensation

8.10.5 SOFT FILL

Soft Fill function is used to bring the process to a certain level at slow speed before the PID Controller start to control. This function can be used e.g. to fill the empty pipe line slowly, avoiding "water hammers" that could otherwise break the pipes.

It is recommended to use Soft Fill function always when using Multi Pump functionality.

P3.13.8.1 SOFT FILL FUNCTION (ID 1094)

The parameter defines the operation mode of Soft Fill function.

Using Soft Fill function in the Multipump system is recommended to avoid the "water hammers" that could break the pipe.

0 = Disabled

Soft Fill function is disabled and not used.

1 = Enabled (Level)

Soft Fill function is enabled. When the drive is started, the drive runs at a constant frequency (P3.13.8.2 Soft Fill Frequency) until the PID feedback signal reaches the soft fill level (P3.13.8.3 Soft Fill Level). When soft fill level is reached, PID controller starts to regulate.

In addition, if the soft fill level is not reached within the soft fill timeout (P3.13.8.4 Soft Fill Timeout), a soft fill fault is generated (if P3.13.8.4 Soft Fill Timeout is set to greater than zero).

The soft fill mode is typically used in vertical installations.

2 = Enabled (Timeout)

Soft Fill function is enabled. When the drive is started, the drive runs at a constant frequency (P3.13.8.2 Soft Fill Frequency) until the soft fill time (P3.13.8.4 Soft Fill Timeout) has elapsed. After the soft filling time, PID controller starts to regulate.

In this mode, soft fill fault is not available.

This soft fill mode is typically used in horizontal installations.

P3.13.8.2 SOFT FILL FREQUENCY (ID 1055)

The parameter defines the constant frequency reference, which is used when Soft Fill function is active.

P3.13.8.3 SOFT FILL LEVEL (ID 1095)

The parameter is used only, if the option "Enabled (Level)" is selected to Soft Fill function parameter(P3.13.8.1 Soft Fill Function).

The parameter defines the PID feedback signal level, which has to be reached before Soft Fill function is deactivated and PID controller starts to regulate.

P3.13.8.4 SOFT FILL TIMEOUT (ID 1096)

The operation of the parameter depends on the selection of Soft Fill function parameter (P3.13.8.1 Soft Fill Function).

If option "Enabled (Level)" is selected to Soft Fill function parameter (P3.13.8.1 Soft Fill Function), this parameter defines the timeout after which the soft fill fault is generated (if the defined soft fill level is not reached).

If option "Enabled (Timeout)" is selected to Soft Fill function parameter (P3.13.8.1 Soft Fill Function), this parameter defines how long the drive runs at the constant soft fill frequency (P3.13.8.2 Soft Fill Frequency) before PID controller starts to regulate.

P3.13.8.5 SOFT FILL FAULT RESPONSE (ID 738)

Fault response selection for F100 - PID Soft Fill Timeout Fault.

- 0 = No Action
- 1 = Alarm
- 2 = Fault (Stop according to stop mode)
- 3 = Fault (Stop by coasting)

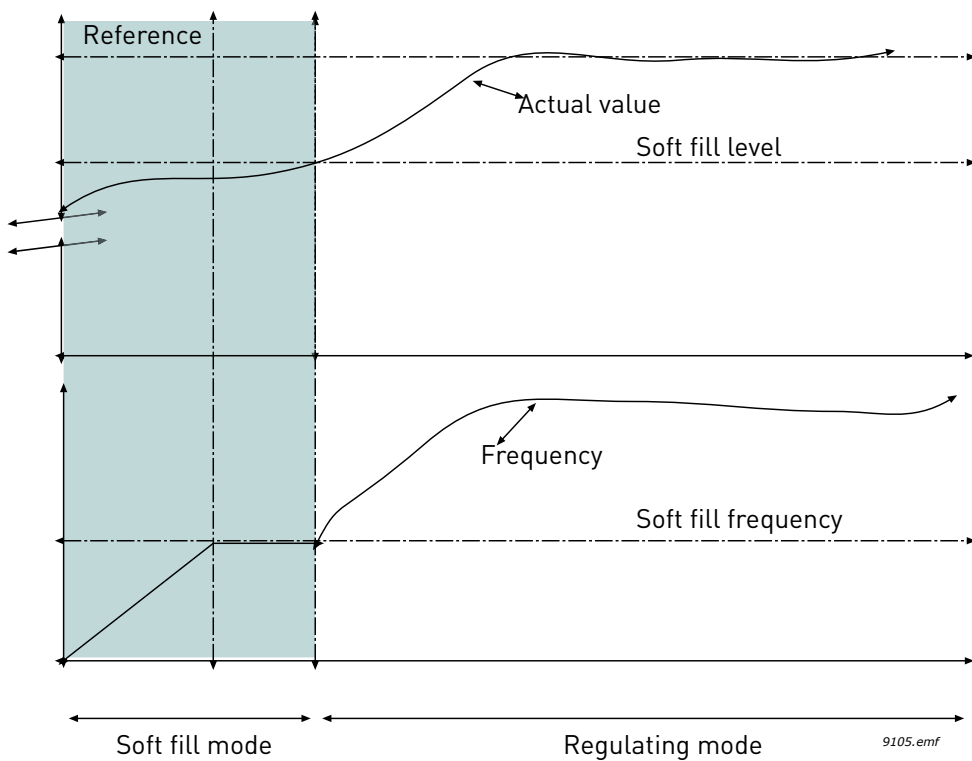

Figure 91. Soft Fill function

8.10.6 SLEEP - NO DEMAND DETECTION FUNCTION

Setpoint is reached and frequency reference is steady within a parametric range band, which is right above the sleep frequency threshold. A temporary bias is added to Actual value. If demand is absent, this will bring the output frequency below the sleep frequency threshold. If Actual value remains stable, the drive will be forced to sleep. See Figure 92. below.

Specifically, if Error (Setpoint-Actual) is within a given hysteresis band across zero:

$$\text{SNDD error hysteresis} \leq \text{Error} \leq \text{SNDD error hysteresis}$$

and the following relation holds true for the amount of time defined by SNDD supervision time:

$$\text{Max[Output Frequency(t)]} - \text{Min[Output Frequency(t)]} < \text{SNDD freq hyst}$$

A temporary bias value is added to Actual value. If Output frequency falls below Sleep frequency threshold for the required amount of time while Error remains within the band, the drive enters sleep mode and Actual value bias is removed.

If any of the following conditions occur:

- The error exceeds the hysteresis band
- Output frequency variation exceeds SNDD frequency hysteresis,

the bias on Actual is removed and normal operation is resumed.

The bias increment on Actual will be positive with direct PID regulation (P3.13.1.8 = Normal), and negative with reverse PID regulation (P3.13.1.8 = Inverted).

The function is enabled by parameter SNDD Enable. The function is inactive, if any of the related parameters = 0.

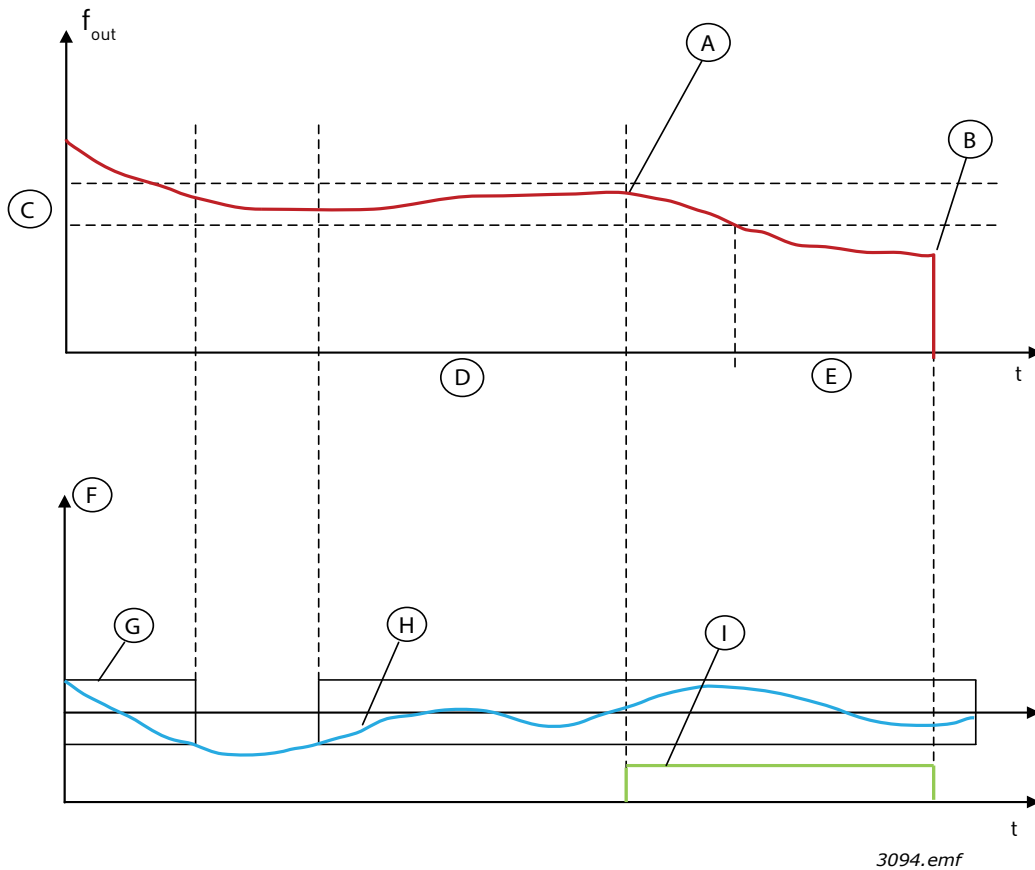

Figure 92. Sleep, no demand detection

- A = Output frequency is within hysteresis for given time, bias is added to actual value here
- B = Entering sleep mode here
- C = SNDD frequency hysteresis (P3.13.10.3)
- D = SNDD Supervision time (P3.13.10.4)
- E = Sleep delay time (P3.13.5.2)
- F = Process unit (P3.13.1.4)
- G = Error band across zero
- H = Error
- I = Actual value bias

8.10.7 INPUT PRESSURE SUPERVISION

The *Input pressure supervision* function is used to supervise that there is enough water in the inlet of the pump, to prevent the pump from sucking air or causing suction cavitation. This function requires a pressure sensor to be installed on the pump inlet, see Figure 93.

If the pump inlet pressure falls below the defined alarm limit, an alarm will be triggered and the pump output pressure reduced by decreasing the PID controller setpoint value. If the inlet pressure still keeps falling below the fault limit, the pump is stopped and a fault will be triggered.

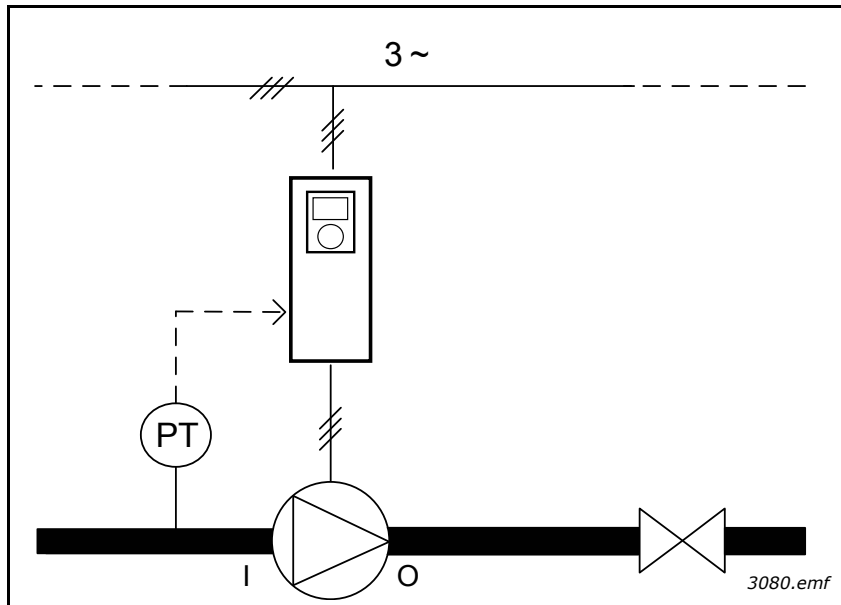

Figure 93. Location of pressure sensor (PT), I = inlet, O = outlet

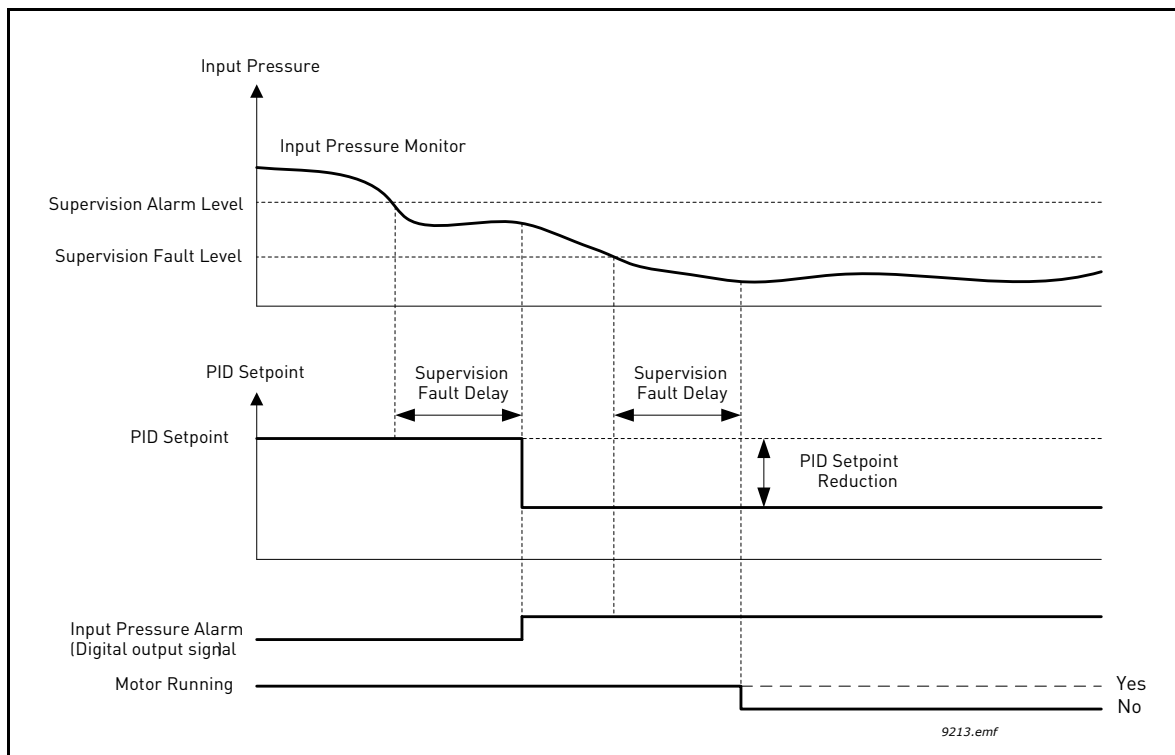

Figure 94. Input pressure supervision

8.1.1 MULTIPUMP FUNCTION

Multipump function is designed for controlling a system where up to 8 motors (e.g. pumps, fans or compressors) are operating in parallel. The internal PID controller of the drive regulates the system by running a necessary number of motors and controlling the speed of the motor(s) depending on the demand.

8.1.1.1 MULTIPUMP (MULTIDRIVE) COMMISSIONING CHECKLIST

The following check list will assist you in configuring the basic settings of the Multipump (Multidrive) system. If you are using keypad for parametrisation, application wizard will also assist you through these basic settings.

Start the commissioning with the drives, which have PID feedback signal (e.g. pressure sensor) connected to an analogue input (default: AI2). Go through all the drives in the system.

1	<p>Check the wirings.</p> <ul style="list-style-type: none"> • Power cabling (mains cable, motor cable): See the drive installation manual. • Control cabling (I/O, PID Feedback sensor, Communication): See the wiring diagramme in chapter 1.5.4.2 and the default I/O connections in chapter 1.5.4.1. • Make sure that the start command is connected to all drives in the system (by default, DI1). • If redundancy is needed, make sure that PID Feedback signal (by default: AI2) is wired at least to two drives. See the wiring instructions in chapter 1.5.4.2.
2	<p>Power up the drive and start parametrisation.</p> <ul style="list-style-type: none"> • Start parametrisation with the drives, which have PID Feedback signal connected. These drives are meant to operate as 'leading drive' (master of the Multipump system). • Parametrisation can be done e.g. with keypad or PC tool.
3	<p>Select 'Multipump (Multidrive)' application configuration with parameter P1.2.</p> <ul style="list-style-type: none"> • Most of the Multipump-related settings and configurations are made automatically, when 'Multi-Pump(Multidrive)' application is selected with parameter P1.2 Application (ID 212). See ch. 1.4.4. • If you are using the keypad for parametrisation, the application wizard will be started when parameter P1.2 Application (ID 212) is changed. The Application wizard will assist you through the most common Multipump-related questions.
4	<p>Set motor parameters.</p> <ul style="list-style-type: none"> • Set motor nameplate parameters according to the rating plate of the motor.

5	<p>Set total number of drives used in the Multipump system.</p> <ul style="list-style-type: none"> • This value is set with parameter P1.35.11 (Quick setup parameter menu). • The same parameter can be found from menu Parameters -> Group 3.15 -> P3.15.2 • By default, the Multipump system is configured for 3 pumps (drives).
6	<p>Select drive operation mode in Multipump system</p> <ul style="list-style-type: none"> • Go to parameter P1.35.13 (Quick setup parameter menu). • The same parameter can be found from menu Parameters -> Group 3.15 -> P3.15.4 • Select 'Leading Drive', if a PID feedback -signal (e.g. pressure sensor) is connected to this drive. • Select 'Auxiliary Drive', if the PID feedback signal is not available.
7	<p>Set pump ID number.</p> <ul style="list-style-type: none"> • Go to parameter P1.35.12 (Quick setup parameter menu). • The same parameter can be found from menu Parameters -> Group 3.15 -> P3.15.3 • Each drive in the Multipump system must have a unique ID number. ID numbers have to be in numerical order, starting from number 1. • Same ID number must not be used for several drives. Otherwise, the communication between drives will not work properly. • Drives, which have a PID feedback signal connected, are typically having the smallest ID numbers (e.g. ID 1 and ID 2) to provide the shortest possible start-up delay when powering up the system.
8	<p>Configure the Interlocking function.</p> <ul style="list-style-type: none"> • Go to parameter P1.35.14 (Quick setup parameter menu). • The same parameter can be found from menu Parameters -> Group 3.15 -> P3.15.5 • By default, the interlocking function is enabled. • Select 'Enabled', if the interlocking signal is connected to the drive's digital input DI5 (Interlocking signal = digital input signal telling if this pump is available in the Multipump system or not). • Otherwise, select 'Not Used'. Then the system assumes that all pumps in the Multipump system are available.
9	<p>Check the source of PID Setpoint signal</p> <ul style="list-style-type: none"> • By default, PID setpoint value is taken from the analogue input AI1. • If constant setpoint value is needed (e.g. always 5 bar), set parameter P1.35.5 Setpoint 1 Source to 'Keypad SP1' and enter the constant setpoint value to parameter P1.35.6 Keypad SP1.

Now, the basic settings of Multipump system are configured. Same check list can be used when configuring the next drives in the system.

8.11.2 SYSTEM CONFIGURATION

Multipump function has two different configurations, depending on the how many drives are included in the system:

Single drive configuration

Single Drive mode is designed to control a system of one variable speed pump and up to 7 auxiliary pumps. The internal PID controller of the drive controls the speed of one pump and gives control signals (via relay outputs) to start/stop the auxiliary pumps. External contactors are needed to switch the auxiliary pumps to supply mains.

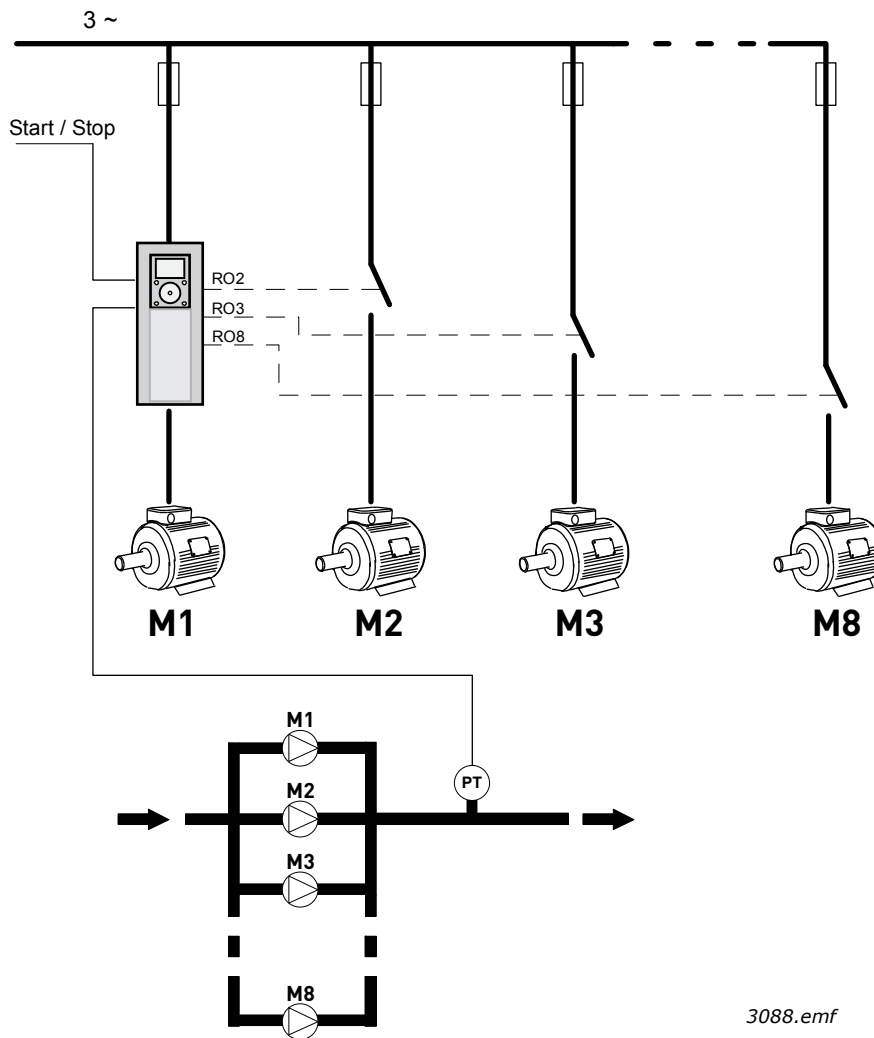

3088.emf

Figure 95. Single drive configuration (PT = pressure sensor)

Multidrive configuration

Multidrive modes (Multimaster and Multifollower) are designed to control a system of up to 8 variable speed pumps. Each pump is controlled by its own drive. The internal PID controller of the drive regulates all pumps. Drives communicate via communication bus (Modbus RTU).

The figure below presents the Multidrive configuration principle. See also the general electric diagramme of a multipump system in chapter 1.5.4.2 Multipump (Multidrive) system electric wiring diagramme.

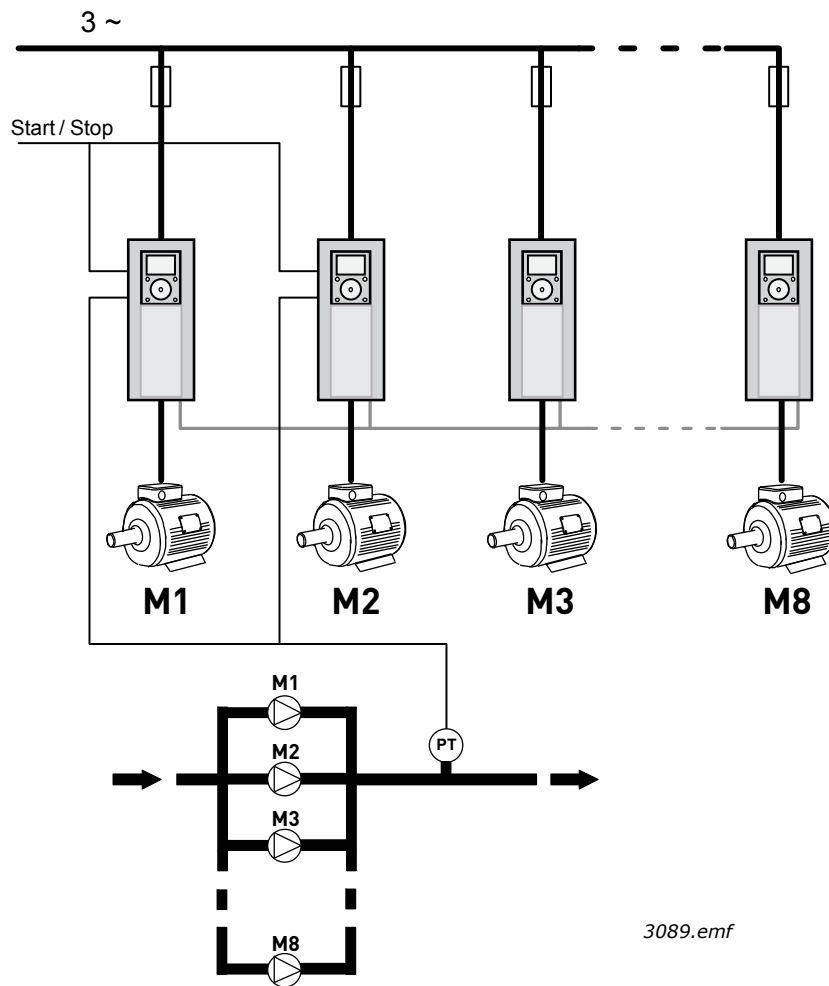

Figure 96. Multidrive configuration (PT = pressure sensor)

P3.15.1 MULTIPUMP MODE (ID 1785)

The parameter defines the configuration and operation mode of Multipump system.

0 = Single drive

Single drive mode is designed to control a system of one variable speed pump and up to 7 auxiliary pumps. The internal PID controller of the drive controls the speed of one pump and gives control signals (via relay outputs) to start/stop the auxiliary pumps. External contactors are needed to switch the auxiliary pumps to supply mains.

One of the pumps is connected to the drive. This pump operates as a regulating pump. When the regulating pump notices a demand for more capacity (running at maximum frequency), but cannot produce this by itself, it requests the next auxiliary pump to start via relay output signal. When the auxiliary pump is started, the regulating pump continues regulating, starting from minimum frequency.

When the regulating pump notices that there is too much capacity (running at minimum frequency), it requests the recently started auxiliary pump to stop. If there are no auxiliary pumps running when the regulating pump notices overcapacity, it will go into Sleep mode (if Sleep function is enabled).

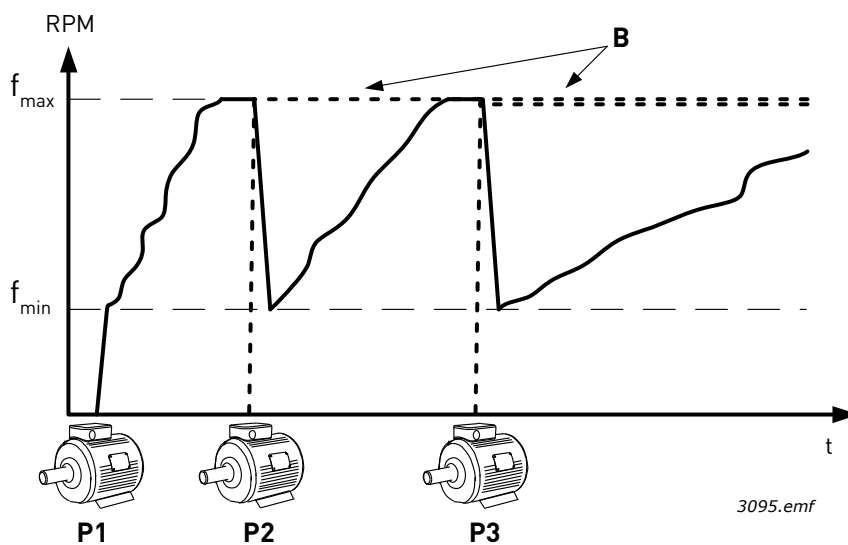

Figure 97. Pump regulation in Single drive mode

- P1 is the regulating pump
- B = Auxiliary pump connected to mains (Direct-On-Line)

1 = Multifollower

Multifollower mode is designed to control a system of up to 8 variable speed pumps. Each pump is controlled by its own drive. The internal PID controller of the drive regulates all pumps.

One of the pumps operates always as a regulating pump. When the regulating pump notices a demand for more capacity (running at maximum frequency), but cannot produce this by itself, it requests the next pump to start via communication bus. Next pump accelerates and starts to run at the speed as the regulating pump. In other words, auxiliary pumps follow the speed of the regulating pump.

When the regulating pump notices that there is too much capacity (running at minimum frequency), it requests the recently started pump to stop. If there are no auxiliary pumps running when the regulating pump notices overcapacity, it will go into Sleep mode (if Sleep function is enabled).

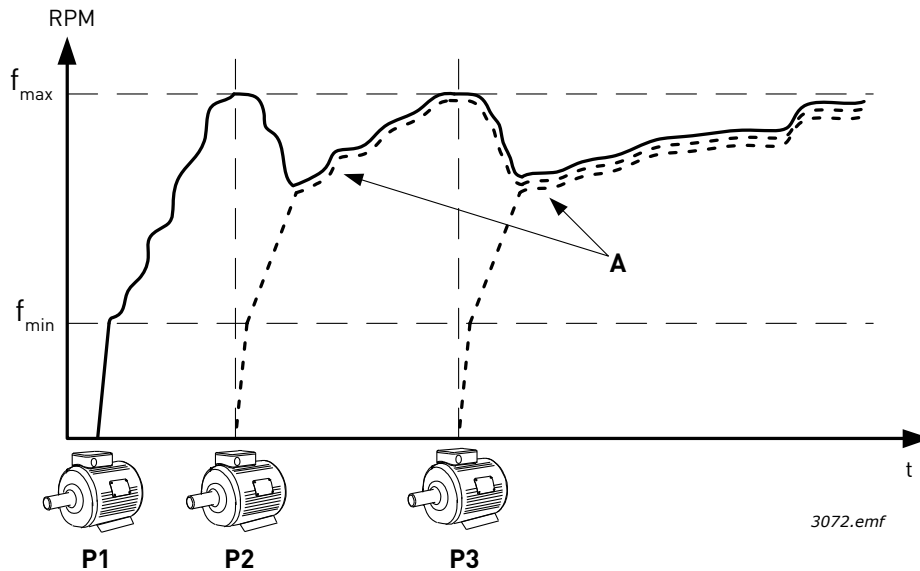

Figure 98. Regulation in Multifollower mode. Pump 1 is regulating, and pumps 2 and 3 are following the speed of pump 1, as shown with curves A.

1 = Multimaster

Multimaster mode is designed to control a system of up to 8 variable speed pumps. Each pump is controlled by its own drive. The internal PID controller of the drive regulates the pumps.

One of the pumps operates always as a regulating pump. When the regulating pump notices a demand for more capacity (running at maximum frequency), but cannot produce this by itself, it locks itself at a constant producing speed and requests the next pump to start and start to regulate.

When the regulating pump notices that there is too much capacity (running at minimum frequency), it stops itself and the pump running at a constant producing speed starts to regulate.

If there are several pumps running at a constant producing speed, the recently started pump starts to regulate. If there are no pumps running at constant producing speed when the regulating pump notices overcapacity, it will go into Sleep mode (if Sleep function is enabled).

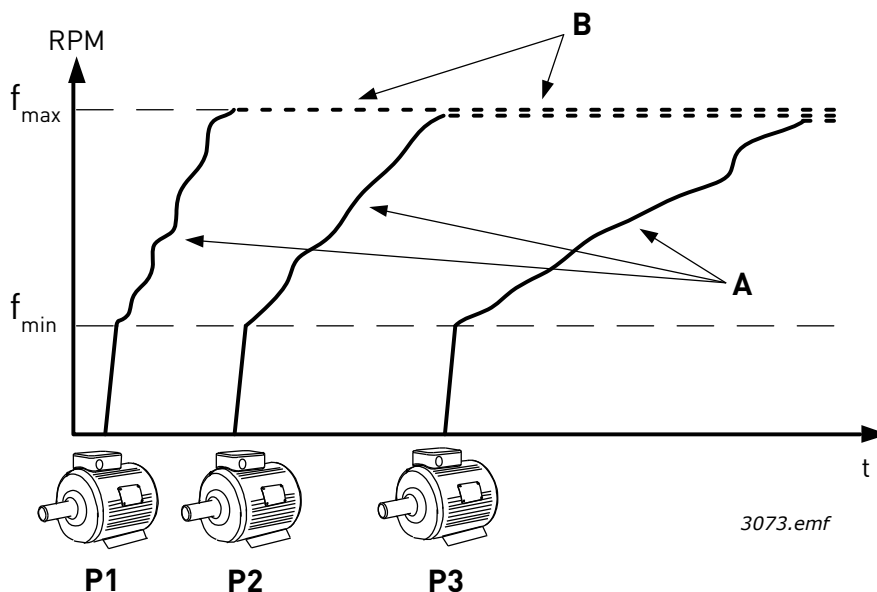

Figure 99. Regulation in Multimaster mode. Curves A show the regulating of the pumps. B = The pumps are locked to constant production frequency

P3.15.2 NUMBER OF PUMPS (ID 1001)

Defines the total number of pumps in the installation. The maximum number of pumps in Multipump system is 8.

This parameter is set by the installation. If you take e.g. one drive out (for pump service), this parameter does not have to be changed.

NOTE! In Multifollower and Multimaster modes, all drives must have the same value in this parameter. Otherwise the communication between drives will not work properly.

P3.15.3 PUMP ID NUMBER (ID 1500)

The parameter is used only in Multifollower and Multimaster modes.

Each drive (pump) in the installation must be given a unique number. First drive in the system should always have the ID number 1 and the numbers of the drives have to be in numerical order.

Pump number 1 is always the primary master of the Multipump system. Drive number 1 is controlling the process and running the PID controller. This means that PID Feedback and PID Setpoint -signals have to be connected to drive number 1.

If the drive number 1 is not available in the system (e.g. drive is powered down or not able to communicate with other drives), the next drive will start to operate as a secondary master of the Multipump system.

NOTE! The communication between drives will not work properly if:

- Pump ID numbers are not in numerical order (starting from 1) or,
- Two drives have the same ID number.

P3.15.4 DRIVE OPERATION MODE (ID 1782)

The parameter is used only, if 'Multifollower' or 'Multimaster' modes are selected with parameter P3.15.1.

The parameter defines whether this drive is able to operate as a master unit of the Multipump system. At least one of the drives in Multipump system have to be configured as the master drive (Leading Drive). Typically, drive number 1 is configured as Leading Drive for ensuring the shortest possible start-up delay for the system in power-up situation.

0 = Auxiliary drive

The drive is able to operate as a slave unit in Multipump system, meaning that e.g. PID feedback or setpoint signals are not connected to this drive. This drive just fulfills the commands (start command and frequency reference) received from the master drive.

1 = Leading drive

The drive is able to operate as a master drive in Multipump system, meaning that the drive's PID controller is configured (parameterised) and PID feedback and setpoint signals are connected to this drive. When operating as 'Leading Drive', this drive regulates the process and gives start commands and frequency references to the other drives in the system.

Redundancy

If redundancy is needed in Multipump (Multidrive) system, several drives can be configured to 'Leading Drive' mode (parameter P3.15.4). This means that if the actual leading drive gets faulted so that it is not able to communicate with the other drives anymore (e.g. power-loss), the next drive (which is configured to 'Leading Drive' -mode) starts to operate as the leading drive after a delay.

NOTE! This requires also that e.g. PID feedback signal is connected to all drives, which are configured to 'Leading Drive' mode.

8.11.3 INTERLOCKS

Interlock function can be used to tell Multipump system by digital input signals, which pumps are available in the system, and which are not. Multipump system controls only the pumps with active interlock data.

This function can be used to tell the Multipump system e.g. if one of the pumps is removed from the system for maintenance. Interlock signals typically come from motor switches.

P3.15.2 INTERLOCK FUNCTION (ID 1001)

Interlocks can be used to tell the Multi Pump system that a motor is not available e.g. because of the motor is removed from the system for maintenance or bypassed for manual control.

Enable this function to use the interlocks. Choose the needed status for each motor by digital inputs (parameters P3.5.1.34 to P3.5.1.37). If the input is closed (TRUE) the motor is available for the Multi Pump system, otherwise it will not be connected by the Multi Pump logic.

8.11.4 FEEDBACK SENSOR CONNECTION IN A MULTIDRIVE SYSTEM

The best accuracy and redundancy in Multipump system is reached by using individual (feedback) sensors for each drive. See Figure 100 below.

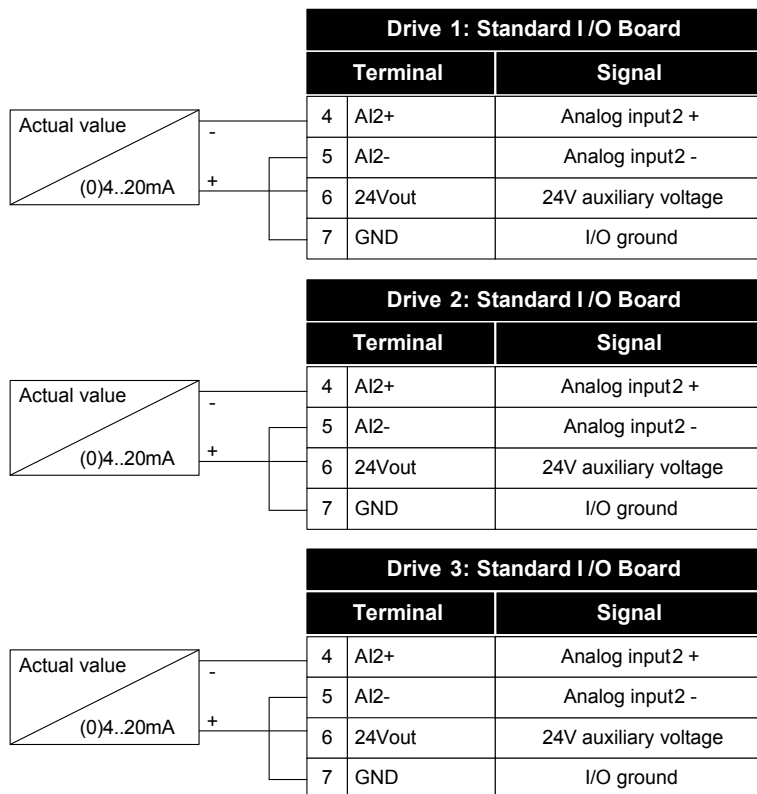

3096.emf

Figure 100. Principle wiring of the individual feedback sensors

A common sensor can also be used. The sensor (transducer) can be supplied either by using the external 24V power supply or from the drive control board.

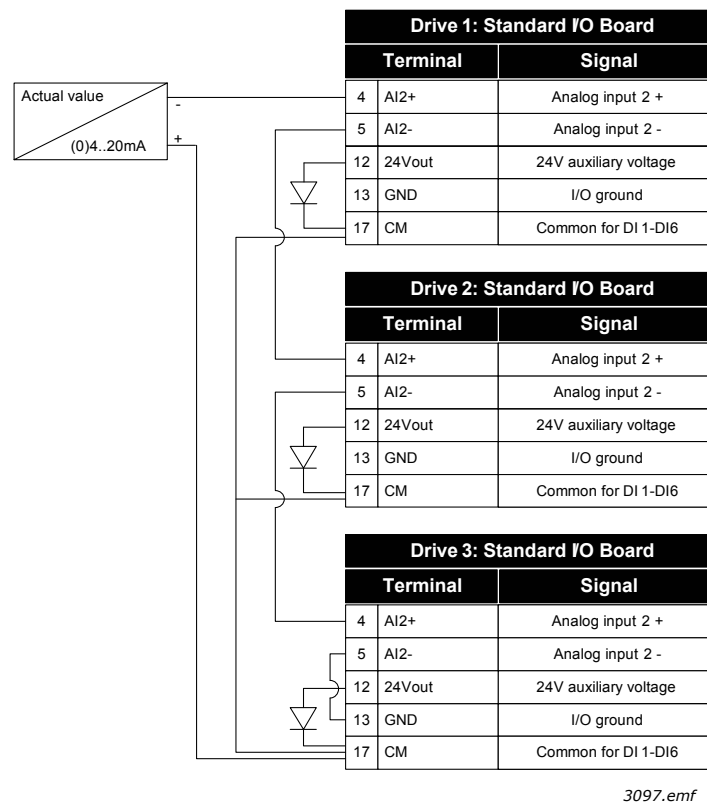

Figure 101. Principle wiring of common sensor (supplied from the drive I/O board)

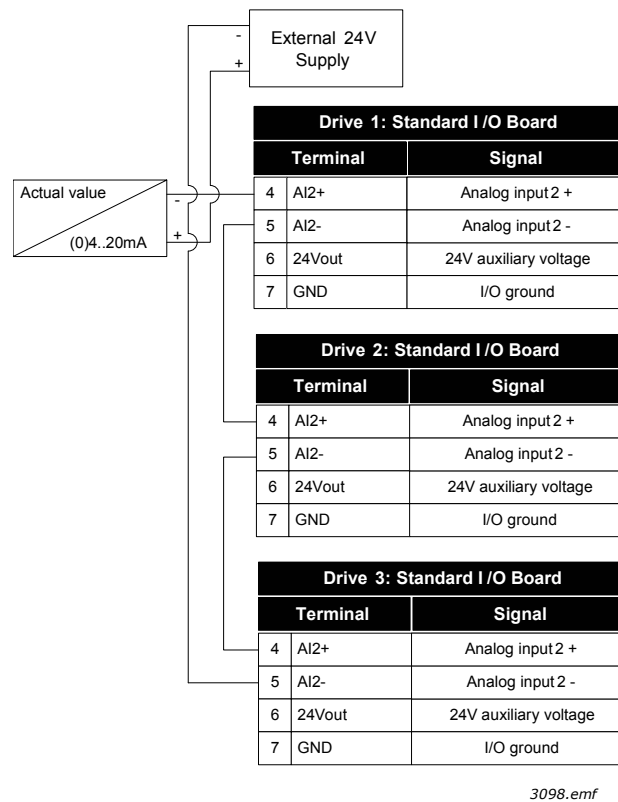

Figure 102. Principle wiring of common sensor (supplied from the external 24V)

In Multidrive configuration, the digital inputs are isolated from the ground, meaning that digital input is active when connected to GND. Isolation DIP switch needs to be set to 'Float' position. See Figure 103. below.

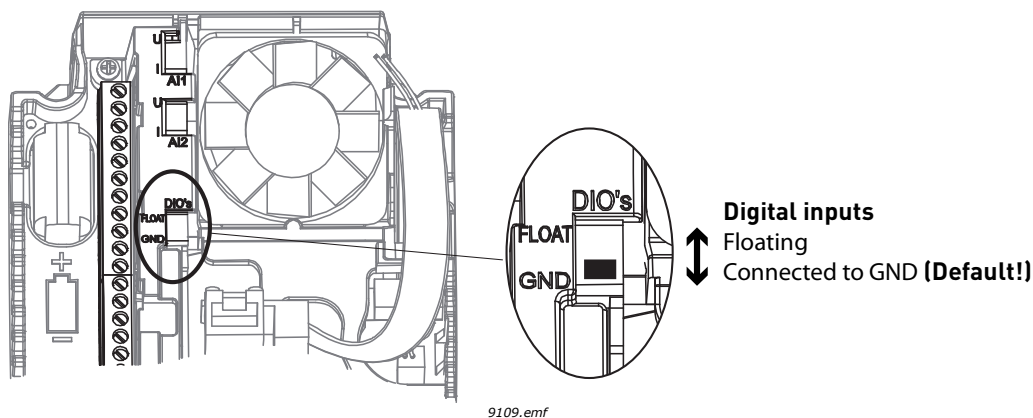

Figure 103. Isolation DIP switch

P3.15.6 AUTOCHANGE (ID 1027)

Table 129.

Selection	Selection name	Description
0	Disabled	The priority/starting order of the motors is always 1-2-3-4-5 in normal operation. It might have changed during run, if interlocks have been removed and added again, but the priority/order is always restored after a stop.
1	Enabled (interval)	Autochange function is enabled. Starting order of the pumps is rearranged at defined interval. The interval time between the starting order rearrangement events is defined by parameter P3.15.8, Autochange Interval. Autochange interval timer is running only when Multipump system is running.
2	Enabled (real time)	Autochange function is enabled. Starting order of the pumps is rearranged at selected weekdays, at the defined time of the day. Autochange days and time of day can be defined with parameters P3.15.9 and P3.15.10 . NOTE! This mode requires RTC-battery to be installed into the drive.

EXAMPLE:

In the autochange sequence after the autochange has taken place, the motor with the highest priority is placed last and the others are moved up by one place:

Starting order/priority of motors: **1->2->3->4->5**

--> Autochange -->

Starting order/priority of motors: **2->3->4->5->1**

--> Autochange -->

Starting order/priority of motors: **3->4->5->1->2**

P3.15.7 AUTOCHANGED PUMPS

Table 130.

Selection	Selection name	Description
0	Auxiliary pumps	Motor 1 (motor connected to AC drive) is always frequency-controlled and not affected by interlocks.
1	All pumps	All motors can be controlled and are affected by interlocks.

NOTE! See also chapter 1.5.3 Multipump (single drive) application.

WIRING

There are two different ways to make the connections depending on whether selection 0 or 1 is set as parameter value.

0 = Auxiliary pumps:

The AC drive or the regulating motor is not included in the autochange or interlocks logic. The drive is directly connected to motor 1 as in Figure 104. below. The other motors are auxiliary ones, connected to the mains by contactors and controlled by relays in the drive.

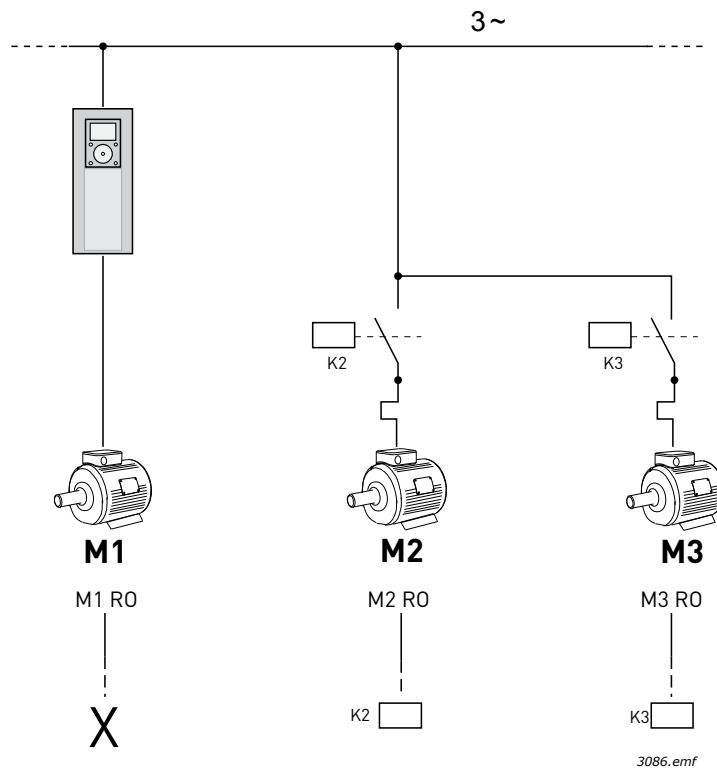

Figure 104. M1-3 RO = Motor control from relay, X = not used

1 = All pumps:

If the regulating motor needs to be included in the autochange or interlock logic, make the connection according to Figure 105. below.

Every motor is controlled with one relay and the contactor logic makes sure that the first connected motor is always connected to the drive and next to the mains.

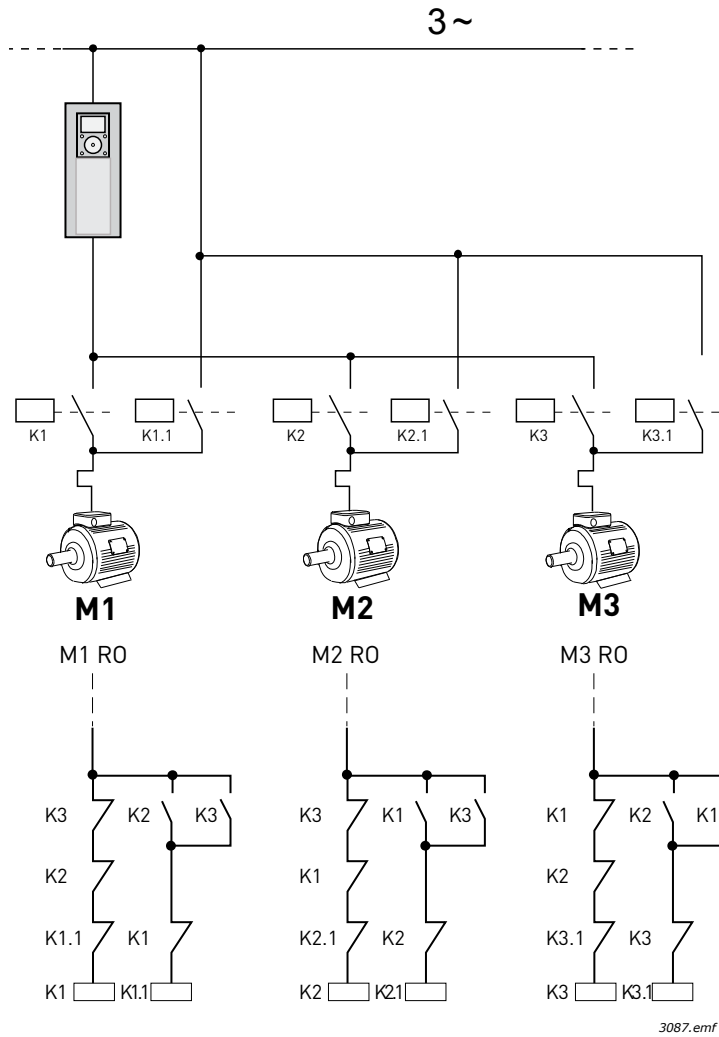

Figure 105. M1-3 RO = Motor control from relay

P3.15.8 AUTOCHANGE INTERVAL (ID 1029)

The parameter defines the interval time between autochange (pump starts to rearrange order) events. This parameter is used only if interval-based autochange mode (1 / Enabled (Interval)) is selected with parameter P3.15.6.

Autochange will take place when the following conditions are fulfilled:

- Multipump system is running (start command is active)
- Autochange interval time has expired
- Regulating pump is running below the frequency defined with parameter P3.15.11

Autochange Frequency Limit

- Number of the running pumps is less or equal to the limit defined with parameter P3.15.12
- Autochange Pump Limit

P3.15.9 AUTOCHANGE DAYS (ID 15904)**P3.15.10 AUTOCHANGE TIME (ID 1787)**

These parameters define the weekdays and the time of the day when the autochange (pump starts to rearrange order) takes place. These parameters are used only if real time-based autochange mode (2 / Enabled (Real Time)) is selected with parameter P3.15.5.

Autochange will take place when the following conditions are fulfilled:

- Multipump system is running (start command is active)
- The defined autochange weekday and the time of the day have been reached
- Regulating pump is running below the frequency defined by parameter P3.15.11.
- Number of the running pumps is less or equal to the limit defined with parameter P3.15.12

P3.15.11 AUTOCHANGE FREQUENCY LIMIT (ID 1031)**P3.15.12 AUTOCHANGE PUMP LIMIT (ID 1030)**

These parameters define the level below which the used capacity must remain so that autochange can take place.

This level is defined as follows:

- If the number of running pumps in Multipump system is less or equal to the limit defined by parameter P3.15.12 and the regulating pump is running below the frequency defined by parameter P3.15.11, the autochange can take place.

NOTE! These parameters are needed mainly in Single drive mode, because an autochange event may need to restart the whole system (depending on how many motors are currently running).

In Multifollower and Multimaster modes it is recommended to set these parameters to their maximum values to allow an autochange event immediately at the autochange time. Multifollower and Multimaster modes are optimised to handle the autochange situation discreetly, regardless of the number of pumps running.

P3.15.13 BANDWIDTH (ID 1097)

P3.15.14 BANDWIDTH DELAY (ID 1098)

These parameters define the conditions for starting/stopping pumps in Multipump system. The number of running pumps is increased/decreased if PID controller is not able to keep the process value (feedback) within the defined bandwidth around the setpoint.

Bandwidth area is defined as a percentage of PID setpoint. As long as the PID feedback value stays inside the bandwidth area, there is no need to increase/decrease the number of running pumps.

When feedback value goes outside the bandwidth area, the time defined by parameter P3.15.14 must elapse before the number of running pumps will be increased/decreased. The figure 90. below shows the criteria for starting and stopping the auxiliary pumps. The number of running pumps is increased/decreased if PID controller is not able to keep the process value (feedback) (C) within the defined bandwidth around the setpoint (D).

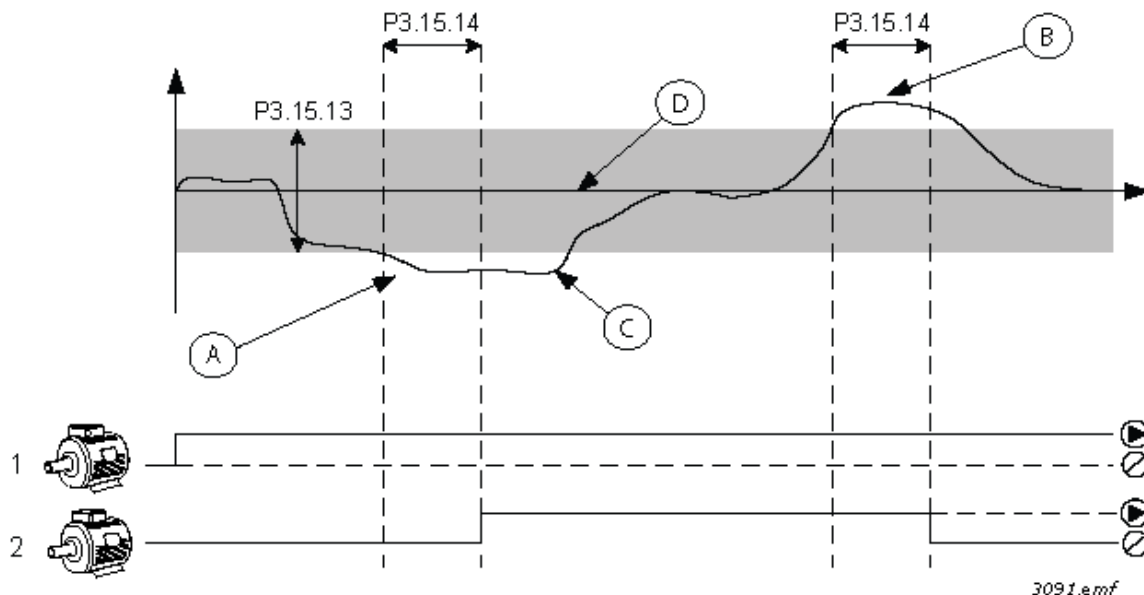

Figure 106. Criteria for starting and stopping the auxiliary pumps. (P3.15.13 = Bandwidth, P3.15.14 = Bandwidth delay)

Criteria for increasing the number of running motors:

- Feedback value is outside the bandwidth area
- Regulating pump is running at a "close-to-max" frequency (-2Hz) (A in the figure)
- There are more pumps available
- Conditions above are fulfilled for a longer time than the bandwidth delay

Criteria for decreasing the number of running motors:

- Feedback value is outside the bandwidth area
- Regulating pump is running at a "close-to-min" frequency (+2Hz) (B in the figure)
- There are more pumps available
- Conditions above are fulfilled for a longer time than the bandwidth delay

P3.15.17.1 PUMP 1 INTERLOCK (ID 426)

The parameter defines the digital input of the drive, where the interlocking (feedback) signal of pump (1) is read.

If Pump Interlocking function (P3.15.5) is enabled, the drive will read the status of Pump Interlock (feedback) digital inputs. If the input is closed (TRUE), the motor is available for Multipump system, otherwise it will not be included to Multipump system.

If Pump Interlocking function (P3.15.5) is not used, the statuses of Pump Interlock (feedback) digital inputs are not read and the Multipump system assumes that all pumps in the system are available.

NOTE!

- In Single drive mode, the digital input signal selected with this parameter, indicates the interlocking status of pump 1 in Multipump system.
- In Multifollower and Multimaster modes, the digital input signal selected with this parameter indicates the interlocking status of the pump, which is connected to this drive.

P3.15.17.2 PUMP 2 INTERLOCK (ID 427)**P3.15.17.3 PUMP 3 INTERLOCK (ID 428)****P3.15.17.4 PUMP 4 INTERLOCK (ID 429)****P3.15.17.5 PUMP 5 INTERLOCK (ID 430)****P3.15.17.6 PUMP 6 INTERLOCK (ID 486)****P3.15.17.7 PUMP 7 INTERLOCK (ID 487)****P3.15.17.8 PUMP 8 INTERLOCK (ID 488)**

These parameters define the digital inputs of the drive, where the interlocking (feedback) signals of pumps 2...8 are read.

NOTE! These parameters are used in Single Drive mode only.

If Pump Interlocking function (P3.15.5) is enabled, the drive will read the status of Pump Interlock (feedback) digital inputs. If the input is closed (TRUE), the motor is available for the Multipump system, otherwise it will not be included to Multipump system.

If Pump Interlocking -function (P3.15.5) is not used, the statuses of Pump Interlock (feedback) digital inputs are not read and the Multipump system assumes that all pumps in the system are available.

8.11.5 OVERPRESSURE SUPERVISION

The Overpressure supervision function is used for pressure supervision in Multipump system. E.g. when the main valve of the pump system is rapidly closed, the pressure in the pipelines will increase quickly. The pressure might even rise too fast for PID controller to react. The Overpressure supervision is used to prevent the pipes from bursting by quickly stopping the running of auxiliary motors in Multipump system.

P3.15.16.1 ENABLE OVERPRESSURE SUPERVISION (ID 1698)

If the Overpressure supervision is enabled and the PID feedback signal (pressure) exceeds the supervision level defined by parameter P3.15.16.2, all auxiliary motors will be stopped in Multipump system. Only the regulating motor keeps running normally. Once the pressure decreases, the system will continue working normally, re-connecting the auxiliary motors one by one. See Figure 107.

The Overpressure supervision function will monitor PID Controller feedback signal and stop all auxiliary pumps immediately, if the signal exceeds the defined overpressure level.

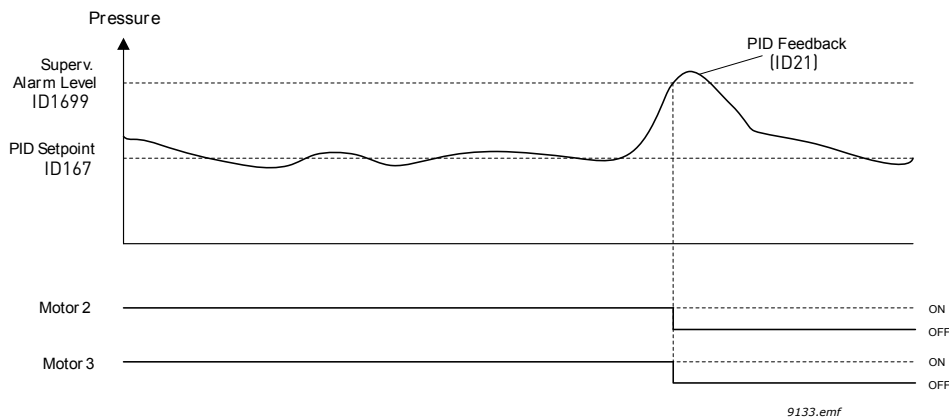

Figure 107. Overpressure supervision

8.11.6 PUMP RUNNING TIME COUNTERS

In Multipump system, the running time of each pump is supervised by an individual run time counter. E.g. the pump starting order is arranged based on the pump runtime counter values for equalising the wear of all pumps in the system.

Pump runtime counters can also be used for indicating the operator that a pump requires maintenance (see P3.15.19.4 - P3.15.19.5 below).

Pump runtime counters can be found from monitoring menu, see chapter 3.1.10.

P3.15.19.1 SET RUNTIME COUNTER (ID 1673)

When this button-type parameter is pressed, the runtime counter of the selected pump(s) (P3.15.19.3) will be set to the defined value.

P3.15.19.2 SET RUNTIME COUNTER: VALUE (ID 1087)

The parameter defines the runtime counter value, which will be set to the runtime counter(s) of the pump(s) selected with P3.15.19.3.

NOTE! In Multimaster and Multifollower modes, it is possible to reset (or set to desired value) only "Pump (1) Running Time" counter. (In Multimaster and Multifollower modes, "Pump (1) Running Time" monitoring value indicates the hours of the pump, which is connected to this drive, regardless from the pump ID number).

Example:

In Multipump (Single drive) system, pump number 4 has been replaced with a totally new pump and the "Pump 4 Running Time" counter value needs to be reset.

1. Select 'Pump' 4 with parameter P3.15.19.3.

2. Set parameter P3.15.19.2 value to '0 h'.
3. Press button-type parameter P3.15.19.1.
4. "Pump 4 Running Time" has been reset.

P3.15.19.3 SET RUNTIME COUNTER: PUMP SELECTION (ID 1088)

The parameter is used to select the pump(s), the runtime counter value of which will be reset (or set to desired value) when button-type parameter P3.15.19.1 is pressed.

If Multipump (Single drive) mode is selected, the following selections are available:

- 0 = All Pumps
- 1 = Pump (1)
- 2 = Pump 2
- 3 = Pump 3
- 4 = Pump 4
- 5 = Pump 5
- 6 = Pump 6
- 7 = Pump 7
- 8 = Pump 8

If Multifollower or Multimaster mode is selected, only the following selection is available:

- 1 = Pump (1)

NOTE! In Multimaster and Multifollower modes, it is possible to reset (or set to desired value) only the "Pump (1) Running Time" counter. (In Multimaster and Multifollower modes, "Pump (1) Running Time" monitoring value indicates the hours of the pump, which is connected to this drive, regardless of the pump ID number).

Example:

In Multipump (Single drive) system, pump number 4 has been replaced with a totally new pump and the "Pump 4 Running Time" counter value needs to be reset.

1. Select 'Pump' 4 by parameter P3.15.19.3.
2. Set parameter P3.15.19.2 value to '0 h'.
3. Press button-type parameter P3.15.19.
4. "Pump 4 Running Time" has been reset.

P3.15.19.4 RUNTIME ALARM LIMIT (ID 1109)

P3.15.19.5 RUNTIME FAULT LIMIT (ID 1110)

Pump runtime counters can also be used for indicating the operator that pump maintenance needs to be carried out. When pump run time counter value exceeds the defined limit, an alarm or fault will be triggered respectively. When the maintenance has been carried out, the runtime counter can be reset (or forced to desired value).

NOTE!

- In Multipump (Single drive) mode, alarm and fault limits are common for all pumps. An alarm or fault will be triggered, if any of the individual runtime counters (Pump 1...Pump 8) exceeds the limit value.
- In Multimaster and Multifollower modes, each drive monitors only its own pump running time ('Pump (1) Running Time'). This means that alarm and fault limits have to be activated and configured individually for each drive.

8.12 MAINTENANCE COUNTERS

The maintenance counter is a way of indicating the operator that maintenance needs to be carried out. For example, a belt needs to be replaced or oil in a gearbox should be changed.

There are two different modes for the maintenance counters, hours or revolutions*1000. The counters are only incremented during Run mode in either case.

NOTE! Revolutions are based on motor speed, which is only an estimate (integration every second).

When the counter exceeds the limit, an alarm or fault will be triggered respectively. Individual maintenance alarm and fault signals can be connected to a digital/relay output.

When maintenance has been carried out, the counter can be reset through either a digital input or a parameter B3.16.4.

8.13 FIRE MODE

NOTE! The Fire mode can also be configured with Fire mode wizard, which can be activated in the Quick Setup menu, P1.1.2, see chapter 1.3 Fire mode wizard.

When Fire mode is activated, the drive will reset all upcoming faults and continue running at the given speed as long as it is possible. The drive ignores all commands from the keypad, fieldbuses and PC tool, excluding Fire mode activation, Fire mode reverse, Run enable, Run interlock1 and Run interlock 2 signals from I/O.

Fire mode function has two operational modes, Test mode and Enabled mode. The operational mode can be selected by entering different passwords to parameter P3.17.1. In Test mode, upcoming errors will not be reset automatically and the drive will stop when faults occur.

When Fire mode function is activated, an alarm is shown on the keypad.

NOTE! THE WARRANTY IS VOID IF THIS FUNCTION IS ACTIVATED! Test Mode can be used to test the Fire Mode -function without voiding the warranty.

P3.17.1 FIRE MODE PASSWORD (ID 1599)

Choose here the operation mode of Fire mode function.

Selection	Selection name	Description
1002	Enabled mode	The drive will reset all upcoming faults and continue running at the given speed as long as it is possible. NOTE! All Fire mode parameters will be locked, if this password has been given. To enable changing Fire mode parameterisation, first change the parameter value to zero first.
1234	Test mode	Upcoming errors will not be reset automatically and the drive will stop if any fault occurs.

P3.17.3 FIRE MODE FREQUENCY (ID 1598)

The parameter defines the constant frequency reference that is used when Fire mode has been activated and *Fire mode frequency* has been selected to frequency reference source in parameter P3.17.2..

See parameter P3.17.6 to select or change the motor rotation direction when Fire mode function is active.

P3.17.4 FIRE MODE ACTIVATION ON OPEN (ID 1596)

If activated, alarm sign is shown on the keypad and warranty is void. In order to enable the function, you need to set a password in the description field for parameter Fire Mode password.

NOTE! NC (normally closed) type of this input

It is possible to test the *Fire mode* without voiding the warranty by using the password that allows the *Fire mode* to run in test state. In the test state, upcoming errors will not automatically be reset and the drive will stop at faults.

NOTE! All Fire mode parameters will be locked, if Fire mode is enabled and correct password is given to the Fire mode Password parameter. To change the Fire mode parameterisation, change the *Fire Mode Password* parameter to zero first.

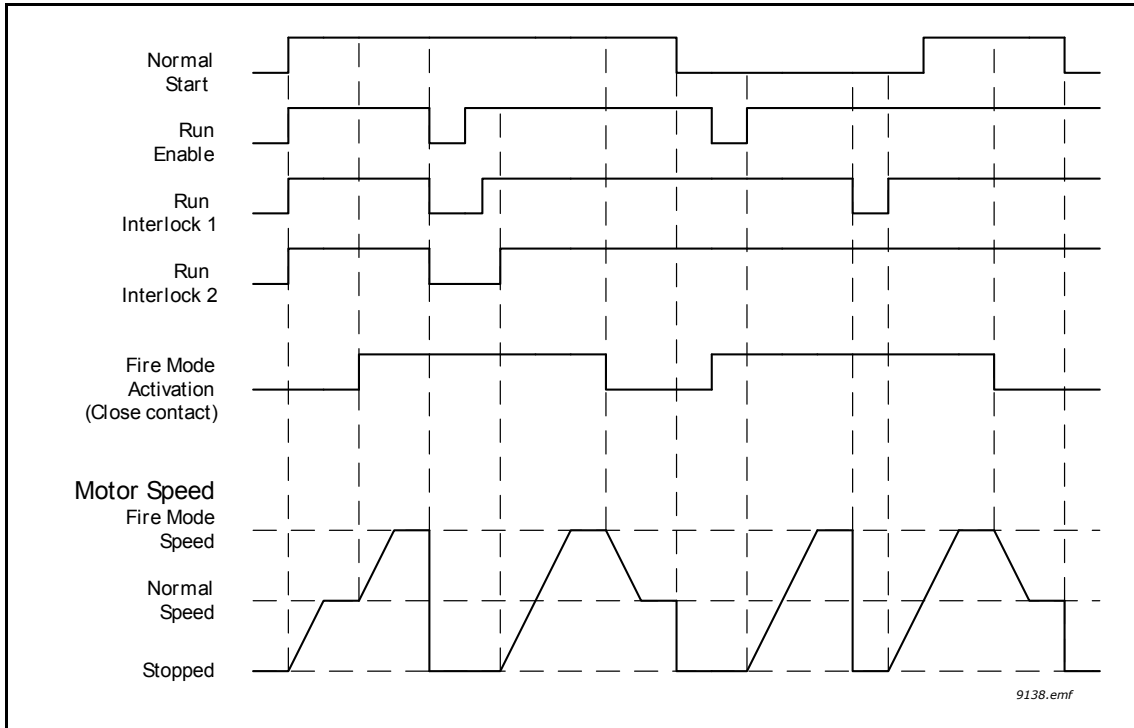

Figure 108. Fire Mode functionality

P3.17.5 FIRE MODE ACTIVATION ON CLOSE (ID 1619)

See above.

P3.17.6 FIRE MODE REVERSE (ID 1618)

The parameter defines the digital input signal to select the motor rotation direction with activated Fire Mode function. It has no effect in normal operation.

If the motor is required to run always FORWARD or always REVERSE in Fire Mode, select:

DigIn Slot0.1 = always FORWARD

DigIn Slot0.2 = always REVERSE

8.14 MOTOR PREHEAT FUNCTION

Motor Preheat function is intended to keep the drive and motor warm in Stop state by injecting DC current to the motor e.g. to prevent condensation. Motor preheat can be activated always either in Stop state by digital input, or when drive heatsink temperature or motor temperature goes below a defined temperature.

P3.18.1 MOTOR PREHEAT FUNCTION (ID 1225)

Motor Preheat function is intended to keep the drive and motor warm in Stop state by injecting DC current to the motor e.g. to prevent condensation.

Table 131. Table

Selection	Selection name	Description
0	Not used	Motor preheat function is disabled.
1	Always in Stop state	Motor preheat function is activated always when the drive is in Stop state.
2	Controlled by digital input	Motor preheat function is activated by a digital input signal, when the drive is in Stop state. The DI for the activation can be selected by parameter P3.5.1.18.
3	Temperature limit (heatsink)	Motor preheat function is activated, if the drive is in Stop state and the temperature of the drive's heatsink goes below the temperature limit defined by parameter P3.18.2.
4	Temperature limit (measured motor temperature)	Motor preheat function is activated if the drive is in Stop mode and the (measured) motor temperature goes below the temperature limit defined by parameter P3.18.2. The measurement signal of the motor temperature can be selected by parameter P3.18.5. NOTE! This operation mode presupposes the installation of a temperature measurement option board (e.g. OPTBH).

8.15 PUMP CONTROL

8.15.1 AUTO-CLEANING

Auto-cleaning function is used to remove any dirt or other material that may have attached to the pump impeller. Auto-cleaning is used e.g. in wastewater systems to keep up the performance of the pump. Auto Cleaning function can also be used to clear the blocked pipe or valve.

The function is based on rapidly accelerating and decelerating the pump. See Figure 109. and the parameter descriptions below:

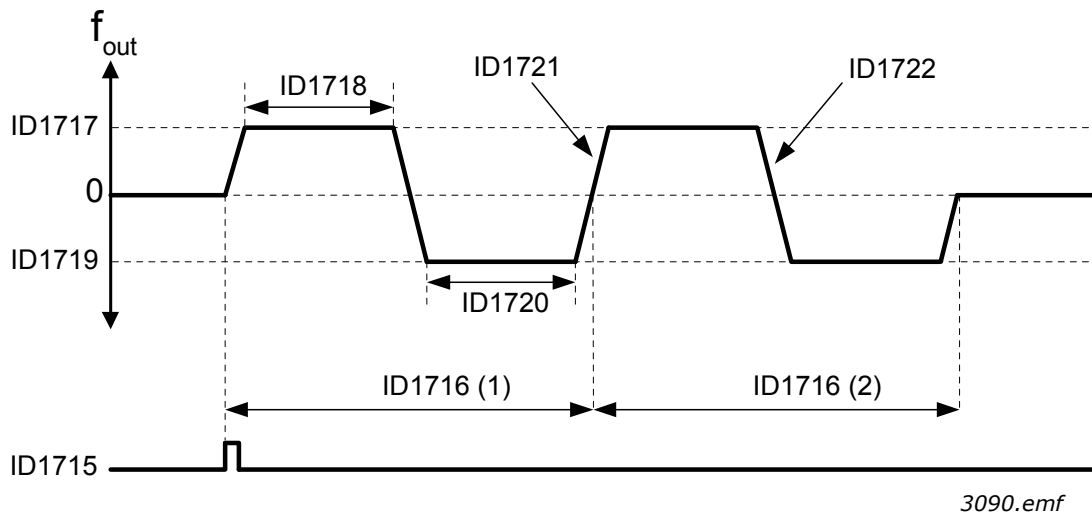

Figure 109. Auto-cleaning function. (0 = zero frequency, ID1716 = cleaning cycles 1 and 2), ID 1715 = P3.5.1.41 Auto-cleaning activation, ID 1717 = P3.21.1.8 Clean forward frequency, ID 1718 = P3.21.1.9 Clean forward time, ID 1719 = P3.21.1.10 Clean reverse frequency, ID 1720 = P3.21.1.11 Clean reverse time, ID 1721 = P3.21.1.12 Cleaning acceleration time, ID 1722 = P3.21.1.13 Cleaning deceleration time

P3.21.1.1 CLEANING FUNCTION (ID 1714)

The parameter defines how the Auto-cleaning sequence is started. The following starting modes are available (when 0 is selected, the cleaning function is not used):

1 = Enabled (DIN)

Cleaning sequence is started with digital input signal. A rising edge on the digital input signal (P3.21.1.2) starts the cleaning sequence, if the drive start command is active. Cleaning sequence can also be activated, if the drive is in sleep mode (PID Sleep).

2 = Enabled (Current)

Cleaning sequence is started when motor current exceeds the defined current limit (P3.21.1.3) for longer than defined with P3.21.1.4.

3 = Enabled (Real Time)

Cleaning sequence is in accordance with the drive's internal Real Time Clock.

NOTE! Requires that the real time clock battery is installed.

Cleaning sequence is started on selected weekdays (P3.21.1.5) at the defined time of the day (P3.21.1.6), if the drive start command is active. Cleaning sequence can also be activated, if the drive is in sleep mode (PID Sleep).

NOTE! The cleaning sequence can always be stopped by deactivating the drive start command.

P3.21.1.2 CLEANING ACTIVATION (ID 1715)

If Auto Cleaning function is enabled by parameter P3.21.1.1, Auto Cleaning sequence will be started by activating the digital input signal selected by parameter P3.21.1.2.

P3.21.1.3 CLEANING CURRENT LIMIT (ID 1712)

P3.21.1.4 CLEANING CURRENT DELAY (ID 1713)

These parameters are used only when P3.21.1.1 = 2.

Cleaning sequence is started when motor current exceeds the defined current limit (P3.21.1.3) for longer than defined with P3.21.1.4 . Current limit is defined as a percentage of motor nominal current.

P3.21.1.5 CLEANING WEEKDAYS (ID 1723)

P3.21.1.6 CLEANING TIME OF DELAY (ID 1700)

These parameters are used only P3.21.1.1 = 3.

NOTE! This mode requires a real time battery to be installed into the drive.

P3.21.1.7 CLEANING CYCLES (ID 1716)

The forward/reverse cycle will be repeated for the amount of times defined by this parameter.

P3.21.1.8 CLEAN FORWARD FREQUENCY (ID 1717)

P3.21.1.9 CLEAN FORWARD TIME (ID 1718)

P3.21.1.10 CLEAN REVERSE FREQUENCY (ID 1719)

P3.21.1.11 CLEAN REVERSE TIME (ID 1720)

The cleaning function is based on rapidly accelerating and decelerating the pump. With these parameters the user can define the forward/reverse cycle times.

P3.21.1.12 CLEANING ACCELERATION TIME (ID 1721)

P3.21.1.13 CLEANING DECELERATION TIME (ID 1722)

The user can also define separated acceleration and deceleration ramps for Auto-cleaning function with these parameters.

8.15.2 JOCKEY PUMP

P3.21.2.1 JOCKEY FUNCTION (ID 1674)

Jockey pump function is used to control a smaller jockey pump by a digital output signal. Jockey pump can be used, if PID Controller is used for controlling the main pump. This function has three operation modes:

Table 132.

Selection number	Selection name	Description
0	Not used	
1	PID sleep	Jockey pump will start when the PID Sleep on the main pump is active and stopped when the main pump wakes from sleep.
2	PID sleep (level)	Jockey pump will start when PID Sleep is active and the PID feedback signal goes below the level defined by parameter P3.21.2.2. Jockey Pump will be stopped when the feedback exceeds the level defined by parameter P3.21.2.3 or the main pump wakes from sleep.

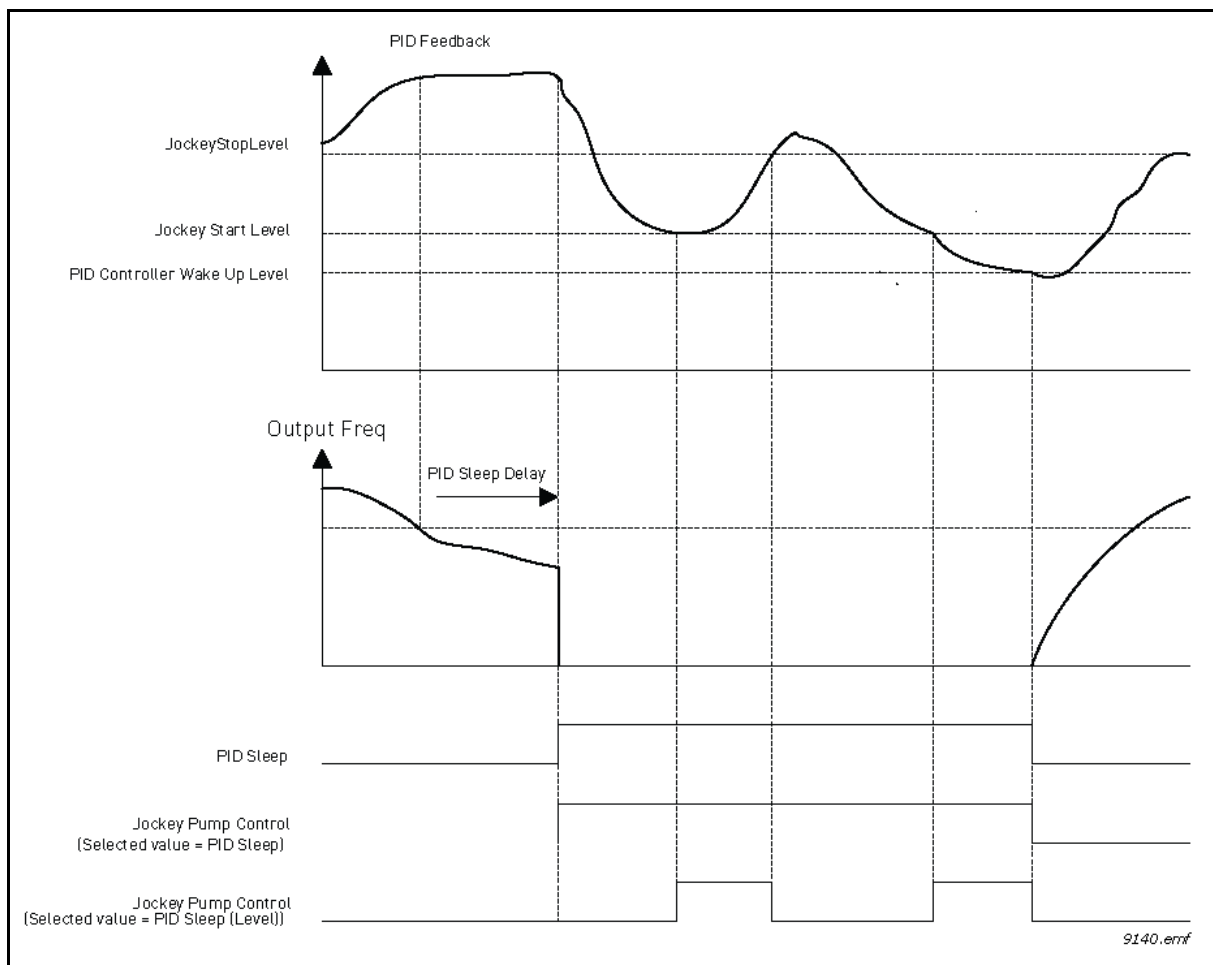

Figure 110. Jockey pump control functionality

8.15.3 PRIMING PUMP

Priming pump is a smaller pump, which is used to prime the inlet of the bigger main pump to prevent the main pump from sucking air.

The priming pump function is used to control a smaller priming pump by the digital output signal. A delay time can be defined to start the priming pump before the main pump is started. Priming pump will run continuously as long the main pump is running.

P3.21.3.1 PRIMING FUNCTION (ID 1677)

Enables the control of an external priming pump via digital output, if *Priming pump control* has been selected for the value of the desired digital output. The priming pump will run continuously as long the main pump is running.

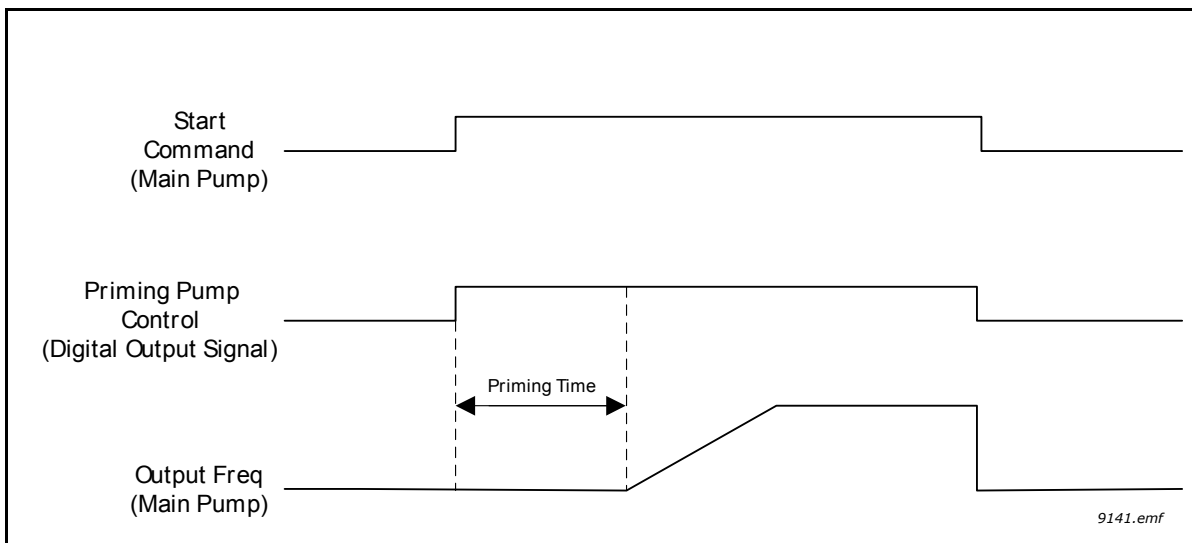

Figure 111.

P3.21.3.2 PRIMING TIME(ID 1678)

Defines the time to start the priming pump before the main pump is started.

8.15.4 ANTI-BLOCKING FUNCTION

Anti-Blocking function prevents the pump from getting blocked if the pump remains stopped (sleeping) a long time, by starting the pump periodically while it is sleeping. Anti-Blocking interval, runtime and speed can be configured.

P3.21.4.1 ANTI-BLOCKING INTERVAL (ID 1696)

When the pump is in sleep mode, this parameter defines the time after which the pump is started at defined speed (P3.21.4.3 Anti-Blocking Frequency) for a defined time (P3.21.4.2 Anti-Blocking Runtime) to prevent the pump from getting blocked when the pump remains in sleep mode for long time.

Anti-Blocking function can be used in both single drive and multidrive systems and it can take place only when the pump is in sleep mode or standby mode (in Multidrive system).

NOTE! Anti-Blocking function is enabled when the value of this parameter is set to greater than zero and disabled when set to zero.

P3.21.4.2 ANTI-BLOCKING RUNTIME (ID 1697)

The parameter defines how long the pump is kept running the Anti-Blocking function is activated.

P3.21.4.3 ANTI-BLOCKING FREQUENCY (ID 1504)

The parameter defines the frequency reference, which is used when Anti-Blocking function is activated.

8.15.5 FROST PROTECTION

Frost Protection function is used to protect the pump from frost damages by running the pump at constant Frost Protection Frequency if the pump is in sleep mode and the measured temperature of the pump goes below the defined protection temperature. The function requires a temperature transducer or a temperature sensor to be installed on the pump covering or the pipe line near the pump.

8.15.6 COUNTERS

Vacon® 100 drive has different counters based on the drive operating time and energy consumption. Some of the counters are measuring total values and some counters can be reset by the user.

Energy counters are used to measure the energy taken from the supply network and the other counters are used to measure e.g. drive operation time or motor running time.

All counter values can be monitored either from PC, Keypad or Fieldbus. In case of Keypad or PC monitoring, counter values can be monitored from *M4 Diagnostics* menu. In case of Fieldbus, counter values can be read by means of ID numbers.

The purpose of this chapter is to describe counter values and ID numbers, which are needed when reading the counter values via Fieldbus.

This chapter is valid for software packages FW0065V017.vcx and FW0072V003.vcx or newer.

Operating Time Counter

Control unit operating time counter (total value). The counter cannot be reset. Counter value can be read from the drive by reading the values of the following ID numbers via Fieldbus.

Operating Time Counter value consists of the following 16-bit (UINT) values.

- ID 1754 Operating Time Counter (years)**
- ID 1755 Operating Time Counter (days)**
- ID 1756 Operating Time Counter (hours)**
- ID 1757 Operating Time Counter (minutes)**
- ID 1758 Operating Time Counter (seconds)**

Example:

Operating Time Counter value '1a 143d 02:21' is read from Fieldbus:

- ID1754: 1 (years)
- ID1755: 143 (days)
- ID1756: 2 (hours)
- ID1757: 21 (minutes)
- ID1758: 0 (seconds)

Operating Time Trip Counter

Resettable control unit operating time counter (trip value). The counter can be reset from PC, Keypad or Fieldbus. Counter value can be read from the drive by reading the values of the following ID numbers via Fieldbus.

Operating Time Trip Counter value consists of the following 16-bit (UINT) values.

- ID 1766 Operating Time Trip Counter (years)**
- ID 1767 Operating Time Trip Counter (days)**
- ID 1768 Operating Time Trip Counter (hours)**
- ID 1769 Operating Time Trip Counter (minutes)**
- ID 1770 Operating Time Trip Counter (seconds)**

Example:

Operating Time Trip Counter value '1a 143d 02:21' is read from Fieldbus:

ID1754: 1 (years)
ID1755: 143 (days)
ID1756: 2 (hours)
ID1757: 21 (minutes)
ID1758: 0 (seconds)

ID 2311 Operating Time Trip Counter Reset

Reset Operating Time Trip Counter.

Operating Time Trip Counter can be reset from PC, Keypad or Fieldbus. In case of PC or Keypad, the counter is reset from M4 Diagnostics menu.

In case of Fieldbus, Operating Time Trip Counter can be reset by writing a rising edge (0 => 1) to **ID2311 Operating Time Trip Counter Reset**.

Run Time Counter

Motor running time counter (total value). The counter cannot be reset. The counter value can be read from the drive by reading the values of the following ID numbers via Fieldbus.

Run Time Counter value consists of the following 16-bit (UINT) values.

ID 1772 Run Time Counter (years)
ID 1773 Run Time Counter (days)
ID 1774 Run Time Counter (hours)
ID 1775 Run Time Counter (minutes)
ID 1776 Run Time Counter (seconds)

Example:

Run Time Counter value '1a 143d 02:21' is read from Fieldbus:

ID1754: 1 (years)
ID1755: 143 (days)
ID1756: 2 (hours)
ID1757: 21 (minutes)
ID1758: 0 (seconds)

Power On Time Counter

Power unit's power on time counter (total value). The counter cannot be reset. The counter value can be read from the drive by reading the values of the following ID numbers via Fieldbus.

Power On Time Counter value consists of the following 16-bit (UINT) values.

ID 1777 Power On Time Counter (years)
ID 1778 Power On Time Counter (days)
ID 1779 Power On Time Counter (hours)
ID 1780 Power On Time Counter (minutes)
ID 1781 Power On Time Counter (seconds)

Example: Power On Time Counter value '1a 240d 02:18' is read from Fieldbus:

ID1754: 1 (years)
 ID1755: 240 (days)
 ID1756: 2 (hours)
 ID1757: 18 (minutes)
 ID1758: 0 (seconds)

Energy counter

Total amount of energy taken from supply network. The counter cannot be reset. The counter value can be read from the drive by reading the values of the following ID numbers via Fieldbus.

Energy Counter value consists of the following 16-bit (UINT) values.

ID 2291 Energy Counter

The counter value has always four significant digits. *Energy Counter* format and unit will be changed dynamically depending on *Energy Counter* value (see the example below).

Energy Counter format and unit can be monitored by **ID2303 Energy Counter Format** and **ID2305 Energy Counter unit**.

Example:

0.001 kWh
 0.010 kWh
 0.100 kWh
 1.000 kWh
 10.00 kWh
 100.0 kWh
 1.000 MWh
 10.00 MWh
 100.0 MWh
 1.000 GWh
 ...etc.

Example:

If value 4500 is read from *ID2291*, and value 42 from *ID2303* and value 0 from *ID2305*:

This means 45.00 kWh.

ID2303 Energy Counter Format

Energy Counter Format defines the decimal point place in the *Energy Counter* value.

40 = 4 number of digits, 0 fractional digits
 41 = 4 number of digits, 1 fractional digit
 42 = 4 number of digits, 2 fractional digits
 43 = 4 number of digits, 3 fractional digits

Example:

0.001 kWh (Format = 43)
100.0 kWh (Format = 41)
10.00 MWh (Format = 42)

ID2305 Energy Counter Unit

Energy Counter unit defines the unit for *Energy Counter* value.

0 = kWh
1 = MWh
2 = GWh
3 = TWh
4 = PWh

Energy Trip Counter

Amount of energy taken from supply network (trip value). The counter can be reset from PC, Keypad or Fieldbus. The counter value can be read from the drive by reading the values of the following ID numbers via Fieldbus.

ID 2296 Energy Trip Counter

The counter value has always four significant digits. *Energy Trip Counter* format and unit will be changed dynamically depending on Energy Trip Counter value (see the example below).

Energy Counter format and unit can be monitored by **ID2307 Energy Trip Counter Format** and **ID2309 Energy trip Counter unit**.

Example:

0.001 kWh
0.010 kWh
0.100 kWh
1.000 kWh
10.00 kWh
100.0 kWh
1.000 MWh
10.00 MWh
100.0 MWh
1.000 GWh
...etc.

ID2307 Energy Trip Counter Format

Energy trip Counter Format defines the decimal point place in the Energy trip Counter value.

40 = 4 number of digits, 0 fractional digits
41 = 4 number of digits, 1 fractional digit
42 = 4 number of digits, 2 fractional digits
43 = 4 number of digits, 3 fractional digits

Example:

0.001 kWh (Format = 43)
100.0 kWh (Format = 41)
10.00 MWh (Format = 42)

ID2309 Energy Trip Counter Unit

Energy Trip Counter unit defines the unit for Energy Trip Counter value.

0 = kWh
1 = MWh
2 = GWh
3 = TWh
4 = PWh

ID2312 Energy Trip Counter Reset

Reset Energy Trip Counter.

Energy Trip Counter can be reset either from PC, Keypad or Fieldbus. In case of PC or Keypad, the counter is reset from the M4 Diagnostics –menu.

In case of Fieldbus, Energy Trip Counter can be reset by writing rising edge (0 => 1) to **ID2312 Energy Trip Counter Reset**.

9. FAULT TRACING

When an unusual operating condition is detected by the AC drive control diagnostics, the drive initiates a notification visible, for example, on the keypad. The keypad will show the code, the name and a short description of the fault or alarm.

The notifications vary in consequence and required action. *Faults* make the drive stop and require reset of the drive. *Alarms* inform of unusual operating conditions and require resetting, but the drive will continue running. *Infos* require resetting but do not affect the functioning of the drive.

For some faults you can programme different responses in the application. See parameter group Protections.

The fault can be reset with the *Reset button* on the control keypad or through the I/O terminal, fieldbus or PC tool. The faults are stored in the Fault history menu which can be browsed. The different fault codes you will find in the table below.

NOTE! When contacting distributor or factory because of a fault condition, always write down all texts on the display, the fault code, the fault ID, the source info, the Active Fault list and the Fault History.

Source info tells the user the origin of the fault, what caused it, where it happened, and other detailed information

9.1 FAULT APPEARS

When a fault appears and the drive stops examine the cause of fault, perform the actions advised here and reset the fault either

- 10. with a long (2 s) press on the *Reset* button on the keypad or
- 11. by entering the *Diagnostics* Menu (M4), entering *Reset faults* (M4.2) and selecting *Reset faults* parameter.

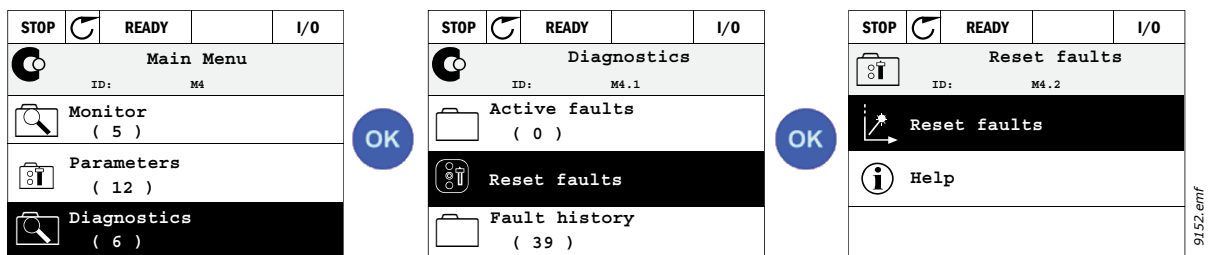

Figure 112.

- 12. For text keypad only: By selecting value Yes for the parameter and clicking OK.

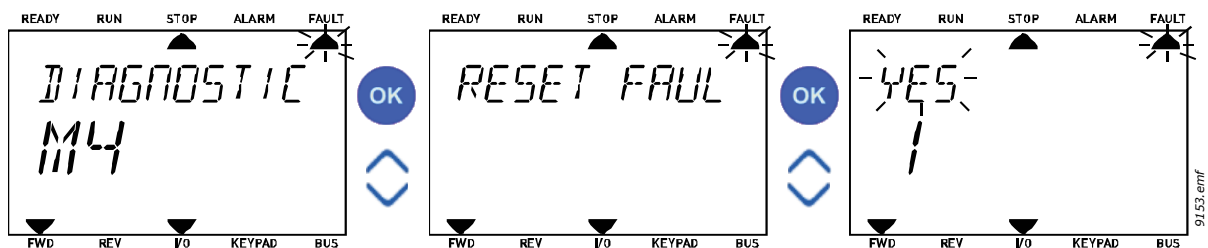

Figure 113.

9.2 FAULT HISTORY

In menu M4.3 Fault history you find the maximum number of 40 occurred faults. On each fault in the memory you will also find additional information, see below.

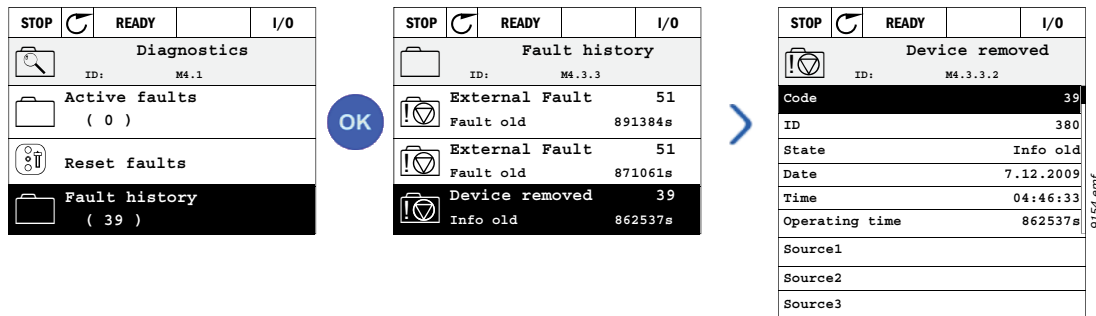

Figure 114.

The displays on the Text keypad:

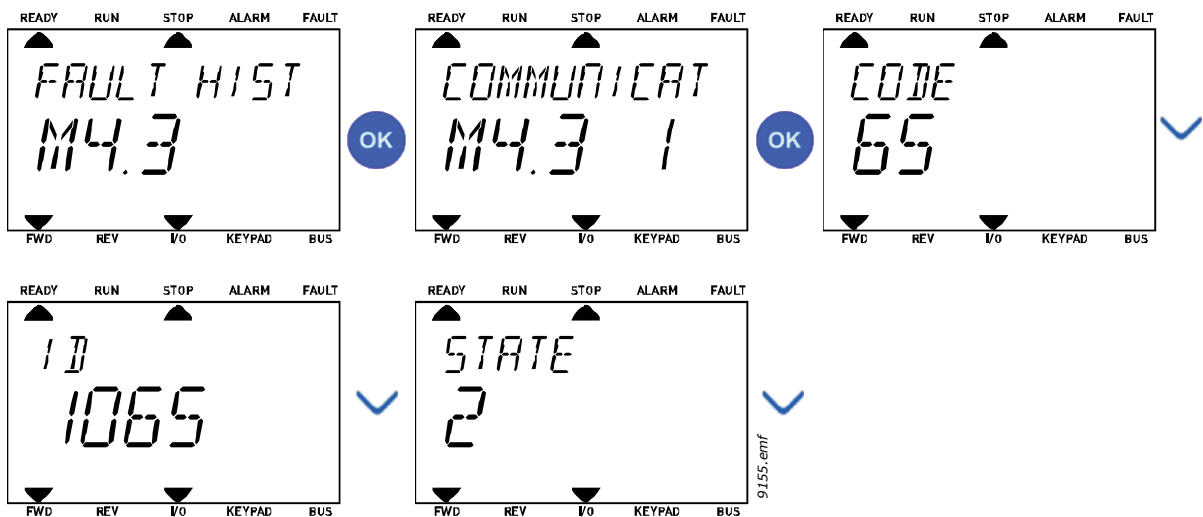

Figure 115.

9.3 FAULT CODES

Table 133. Fault codes and descriptions

Fault code	Fault ID	Fault name	Possible cause	Remedy
1	1	Overcurrent (hardware fault)	AC drive has detected too high a current ($>4 \cdot I_M$) in the motor cable:	Check loading. Check motor. Check cables and connections. Make identification run. Set acceleration time longer (P3.4.1.2/ P3.4.2.2).
	2	Overcurrent (software fault)	<ul style="list-style-type: none"> • sudden heavy load increase • short circuit in motor cables • unsuitable motor • parameter settings are not properly made 	
2	10	Overvoltage (hardware fault)	The DC-link voltage has exceeded the limits defined.	Set deceleration time longer (P3.4.1.3/P3.4.2.3). Activate overvoltage controller. Check input voltage.
	11	Overvoltage (software fault)	<ul style="list-style-type: none"> • too short a deceleration time • high overvoltage spikes in supply 	
3	20	Earth fault (hardware fault)	Current measurement has detected that the sum of motor phase current is not zero.	Check motor cables and motor. Check filters.
	21	Earth fault (software fault)	<ul style="list-style-type: none"> • insulation failure in cables or motor • filter (du/dt, sinus) failure 	
5	40	Charging switch	Charging switch is closed and the feedback information still is 'OPEN'. <ul style="list-style-type: none"> • faulty operation • component failure 	Reset the fault and restart. Check the feedback signal and the cable connection between the control board and the power board. Should the fault re-occur, contact the distributor near to you.
7	60	Saturation	Various causes: <ul style="list-style-type: none"> • IGBT does not execute its operation (is defective) • de-saturation short-circuit in IGBT • brake resistor short-circuit or overload 	Cannot be reset from keypad. Switch off power. DO NOT RESTART or RE-CONNECT POWER! Contact factory.

Fault code	Fault ID	Fault name	Possible cause	Remedy	
8	600	System fault	Communication between control board and power unit has failed.	Reset the fault and restart. Download and update with the latest software available on Vacon website. Should the fault re-occur, contact the distributor near to you.	
	601		Component failure. Faulty operation.		
	602		Component failure. Faulty operation. Voltage of auxiliary power in power unit is too low.		
	603		Component failure. Faulty operation. Output phase voltage does not follow the reference. Feedback fault.		
	604		Component failure. Faulty operation.		
	605		Control and power unit software are incompatible		
	606		Software version cannot be read. There is no software in power unit. Component failure. Faulty operation (power board or measurement board problem).		
	607		CPU overload.		
	608		Component failure. Faulty operation.		RESET the fault and power the drive down twice. Download and update with the latest software available on Vacon website.
	609		Component failure. Faulty operation.		Reset the fault and restart. Download and update with the latest software available on Vacon website. Should the fault re-occur, contact the distributor near to you.
	610		Configuration error Software error Component failure (control board) Faulty operation		
	614		Component failure. Faulty operation.		
	647		Faulty operation. System software and application are not compatible.		
	648		Resource overload. Parameter loading, restoring or saving failure.		
	649				

Fault code	Fault ID	Fault name	Possible cause	Remedy
9	80	Undervoltage (fault)	DC-link voltage is under the voltage limits defined. <ul style="list-style-type: none"> • too low a supply voltage • component failure • defect input fuse • external charge switch not closed NOTE! This fault is activated only if the drive is in Run state.	In case of temporary supply voltage break reset the fault and restart the AC drive. Check the supply voltage. If it is adequate, an internal failure has occurred. Check the electrical network for failures. Contact the distributor near to you.
10	91	Input phase	<ul style="list-style-type: none"> • problem in supply voltage • fuse failure or failure in the supply cables The load must be 10-20% minimum in order to the supervision to work.	Check supply voltage, fuses and supply cable, rectifying bridge and gate control of the thyristor (MR6->).
11	100	Output phase supervision	Current measurement has detected missing current in one motor phase. <ul style="list-style-type: none"> • problem in motor or motor cables. • filter (du/dt, sinus) failure 	Check motor cable and motor. Check the du/dt or sinus filter.
12	110	Brake chopper supervision (hardware fault)	No brake resistor installed. Brake resistor is broken.	Check brake resistor and cabling. If these are ok, the resistor or the chopper is faulty. Contact the distributor near to you.
	111	Brake chopper saturation alarm	Brake chopper failure.	
13	120	AC drive undertemperature (fault)	Too low temperature measured in power unit's heatsink or on power board.	The ambient temperature is too low for the AC drive. Move the AC drive in a warmer place.
14	130	AC drive overtemperature (fault, heatsink)	Too high temperature measured in power unit's heatsink or on the power board. NOTE! Heatsink temperature limits are frame-specific.	Check the actual amount and flow of cooling air. Check the heatsink for dust. Check the ambient temperature. Make sure that the switching frequency is not too high in relation to ambient temperature and motor load. Check cooling fan.
	131	AC drive overtemperature (alarm, heatsink)		
	132	AC drive overtemperature (fault, board)		
	133	AC drive overtemperature (alarm, board)		
15	140	Motor stall	Motor is stalled.	Check motor and load.
16	150	Motor overtemperature	Motor is overloaded.	Decrease motor load. If no motor overload exists, check the temperature model parameters (parameter Group 3.9: Protections).
17	160	Motor underload	Motor is underloaded.	Check load. Check parameters. Check du/dt and sinus filters.

Fault code	Fault ID	Fault name	Possible cause	Remedy
19	180	Power overload (short-time supervision)	AC drive power is too high.	Decrease load. Check dimensioning of drive. Is it too small for the load?
	181	Power overload (long-time supervision)		
25	240 241	Motor control fault	Appears only in customer specific application, if the feature is in use. Start angle identification has failed. <ul style="list-style-type: none"> • Rotor moves during identification • New identified angle does not match with existing value 	Reset the fault and restart the AC drive. Increase identification current level. See fault history source for more info.
26	250	Start-up prevented	Start-up of the drive has been prevented. Run request is ON when a new software (firmware or application), parameter setting or any other file, which has affects the operation of the drive, has been loaded to drive.	Reset the fault and stop the AC drive. Load the software and start the AC drive.
29	280	Atex thermistor	Atex thermistor has detected the overtemperature	Reset the fault. Check thermistor and its connections.
30	290	Safe Off	Safe Off signal A does not allow AC drive to be set to READY state	Reset the fault and restart the AC drive.
	291	Safe Off	Safe Off signal B does not allow AC drive to be set to READY state	Check the signals from the control board to the power unit and the D connector.
	500	Safety configuration	Appears when the Safety Configuration Switch has been installed	Remove the Safety Configuration Switch from the control board.
	501	Safety configuration	Too many STO option boards have been detected in the drive. Only one is supported.	Remove the extra STO option boards. See Safety manual.
	502	Safety configuration	STO option board has been installed in incorrect slot.	Place the STO option board into correct slot. See Safety manual.
	503	Safety configuration	Safety Configuration Switch is missing from the control board.	Install the Safety Configuration Switch on the control board. See Safety manual.
	504	Safety configuration	Safety Configuration Switch has been installed incorrectly on the control board.	Install the Safety Configuration Switch in correct place on the control board. See Safety manual.
	505	Safety configuration	Safety Configuration Switch on the STO option board has been installed incorrectly.	Check the Safety configuration switch installation on the STO option board. See Safety manual.
	506	Safety configuration	Communication with STO option board has been lost.	Check the installation of STO option board. See Safety manual.
507	Safety configuration	Hardware does not support STO option board	Reset the drive and restart. If the fault reoccurs contact your nearest distributor.	

Fault code	Fault ID	Fault name	Possible cause	Remedy
30	520	Safety diagnostics	Component failure on STO option board	Reset the drive and restart. If the fault reoccurs change the option board.
	521	Safety diagnostics	ATEX thermistor diagnostic fault. ATEX thermistor input connection has failed.	
	522	Safety diagnostics	Short-circuit in ATEX thermistor input connection.	Check ATEX thermistor input connection. Check external ATEX connection. Check external ATEX thermistor.
	530	Safe torque off	Emergency stop button has been connected or some other STO operation has been activated.	When the STO function is activated, the drive is in safe state.
32	311	Fan cooling	Fan speed does not follow the speed reference accurately. However, the AC drive operates properly. This fault appears in MR7 and bigger drives only.	Reset the fault and restart. Clean or change the fan.
	312	Fan cooling	Fan life time (50,000h) is up.	Change fan and reset fan life time counter.
33	320	Fire mode enabled	Fire mode of the drive is enabled. The drive's protections are not in use. NOTE! This alarm is automatically reset when fire mode is disabled.	Check the parameter settings and signals. Some of the driver protections are disabled.
37	361	Device changed (same type)	Power unit has been changed for another of corresponding size. The device is ready to use. Parameters are already available in the drive.	Reset the fault. NOTE! Drive reboots after reset.
	362	Device changed (same type)	Option board in slot B changed for one previously inserted in the same slot. The device is ready to use.	Reset the fault. Old parameter settings will be used.
	363	Device changed (same type)	Same as ID362 but refers to Slot C.	See above.
	364	Device changed (same type)	Same as ID362 but refers to Slot D.	See above.
	365	Device changed (same type)	Same as ID362 but refers to Slot E.	See above.
38	372	Device added (same type)	Option board added into slot B. The option board was previously inserted in the same slot. The device is ready to use.	Device is ready for use. Old parameter settings will be used.
	373	Device added (same type)	Same as ID372 but refers to Slot C.	See above.
	374	Device added (same type)	Same as ID372 but refers to Slot D.	See above.
	375	Device added (same type)	Same as ID372 but refers to Slot E.	See above.

Fault code	Fault ID	Fault name	Possible cause	Remedy
39	382	Device removed	Option board removed from slot A or B.	Device no longer available. Reset the fault.
	383	Device removed	Same as ID380 but refers to Slot C	
	384	Device removed	Same as ID380 but refers to Slot D	
	385	Device removed	Same as ID380 but refers to Slot E	
40	390	Device unknown	Unknown device connected (power unit/option board)	Device no longer available. If the fault reoccurs contact your nearest distributor.
41	400	IGBT temperature	Calculated IGBT temperature is too high. <ul style="list-style-type: none"> • Too high a motor load • Ambient temperature too high • Hardware failure 	Check parameter settings. Check actual amount and flow of cooling air. Check ambient temperature. Check heatsink for dust. Make sure that switching frequency is not too high in relation to ambient temperature and motor load. Check cooling fan. Make identification run.
44	431	Device changed (different type)	Different type of power unit changed. Parameters are not available in the settings.	Reset the fault. NOTE! Drive reboots after the reset. Set power unit parameters again.
	433	Device changed (different type)	Option board in slot C changed for one not present in the same slot before. No parameter settings are saved.	Reset the fault. Set option board parameters again.
	434	Device changed (different type)	Same as ID433 but refers to Slot D.	See above.
	435	Device changed (different type)	Same as ID433 but refers to Slot D.	See above.
45	441	Device added (different type)	Different type of power unit added. Parameters are not available in the settings.	Reset the fault. NOTE! Drive reboots after the reset. Set power unit parameters again.
	443	Device added (different type)	Option board not present in the same slot before added in slot C. No parameter settings are saved.	Set option board parameters again.
	444	Device added (different type)	Same as ID443 but refers to Slot D.	See above.
	445	Device added (different type)	Same as ID443 but refers to Slot E.	See above.
46	662	Real Time Clock	RTC battery voltage level is low and the battery should be changed.	Replace the battery.
47	663	Software updated	Software of the drive has been updated (either the whole software package or application).	No actions needed.

Fault code	Fault ID	Fault name	Possible cause	Remedy
50	1050	AI low fault	At least one of the available analogue input signals has gone below 50% of the defined minimum signal range. Control cable is broken or loose. Signal source has failed.	Change the failed parts. Check the analogue input circuit. Check that parameter <i>AI1 signal range</i> is set correctly.
51	1051	Device external fault	Digital input signal defined by parameter P3.5.1.11 or P3.5.1.12 has been activated to indicate the fault situation in external device.	User-defined fault. Check digital inputs/ schematics.
52	1052 1352	Keypad communication fault	The connection between the control keypad and AC drive is broken	Check keypad connection and possible keypad cable
53	1053	Fieldbus communication fault	The data connection between the fieldbus master and fieldbus board is broken	Check installation and fieldbus master.
54	1354	Slot A fault	Defective option board or slot	Check board and slot. Contact your nearest distributor.
	1454	Slot B fault		
	1554	Slot C fault		
	1654	Slot D fault		
	1754	Slot E fault		
57	1057	Identification	Identification run has failed.	Check that motor is connected to the drive. Make sure that there is no load on the motor shaft. Make sure that the start command will not be removed before completion of identification run.
63	1063	Quick Stop fault	Quick stop activated	Check reason for quick stop activation. Once found and corrective actions taken, reset the fault and restart the drive. See parameter P3.5.1.26 and parameter group 3.4.22.5.
	1363	Quick Stop alarm	Quick stop activated	
65	1065	PC communication fault	The data connection between the PC and AC drive is broken	Check the installation, cable and terminals between the PC and the AC drive.
66	1366	Thermistor input 1 fault	The thermistor input has detected an increase of motor temperature	Check motor cooling and load. Check thermistor connection. If thermistor input is not in use it has to be short circuited. Contact your nearest distributor.
	1466	Thermistor input 2 fault		
	1566	Thermistor input 3 fault		

Fault code	Fault ID	Fault name	Possible cause	Remedy
68	1301	Maintenance counter 1 alarm	Maintenance counter has reached the alarm limit.	Carry out the needed maintenance and reset counter. See parameters B3.16.4 or P3.5.1.40.
	1302	Maintenance counter 1 fault	Maintenance counter has reached the fault limit.	
	1303	Maintenance counter 2 alarm	Maintenance counter has reached the alarm limit.	
	1304	Maintenance counter 2 fault	Maintenance counter has reached the alarm limit.	
69	1310	Fieldbus communication fault	Non-existing ID number is used for mapping values to Fieldbus Process Data Out.	Check parameters in Fieldbus Data Mapping menu (chapter 4.6).
	1311		Not possible to convert one or more values for Fieldbus Process Data Out.	The value being mapped may be of undefined type. Check parameters in Fieldbus DataMapping menu (chapter 4.6).
	1312		Overflow when mapping and converting values for Fieldbus Process Data Out (16-bit).	Check parameters in Fieldbus Data Mapping menu (chapter 4.6).
76	1076	Start prevented	Start command is active and was blocked in order to prevent unintentional rotation of the motor during the first power-up.	Reset drive to restore the normal operation. The need of restart depends on the parameter settings.
77	1077	>5 connections	Maximum number of 5 simultaneous active fieldbus or PC tool connections supported by the application exceeded.	Remove excessive active connections.
100	1100	Soft fill timeout	The Soft fill function in the PID controller has timed out. The desired process value was not achieved within this time.	Reason might be a pipe burst. Check the process. Check the parameters in the Soft fill menu M3.13.8.
101	1101	Feedback supervision fault (PID1)	PID controller: Feedback value has gone beyond supervision limits (P3.13.6.2, P3.13.6.3) and the delay (P3.13.6.4) if set.	Check the process. Check parameter settings, supervision limits and delay.
105	1105	Feedback supervision fault (ExtPID)	External PID controller: Feedback value has gone outside supervision limits (P3.14.4.2, P3.14.4.3) and the delay (P3.14.4.4) if set.	Check the process. Check parameter settings, supervision limits and delay.
109	1109	Input pressure supervision	Input pressure supervision signal (P3.13.9.2) has gone below the alarm limit (P3.13.9.7).	Check the process. Check the parameters in menu M3.13.9.
	1409		Input pressure supervision signal (P3.13.9.2) has gone below the fault limit (P3.13.9.8).	Check the input pressure sensor and connections.

Fault code	Fault ID	Fault name	Possible cause	Remedy
111	1315	Temperature fault 1	At least one of the selected temperature input signals (P3.9.6.1) has reached the alarm limit (P3.9.6.2).	Find the cause of temperature raise. Check the temperature sensor and connections. Check that the temperature input is hardwired if no sensor is connected. See option board manual for further information.
	1316		At least one of the selected temperature input signals (P3.9.6.1) has reached the fault limit (P3.9.6.3).	
112	1317	Temperature fault 2	At least one of the selected temperature input signals (P3.9.6.5) has reached the fault limit (P3.9.6.6).	
	1318		At least one of the selected temperature input signals (P3.9.6.5) has reached the fault limit (P3.9.6.7).	
113	1113	Pump running time	In Multipump system, at least one of the pump runtime counters has exceeded a user-defined alarm limit	Carry out the needed maintenance actions, reset the runtime counter and reset the alarm. (See ch. 4.15.4)
	1313	Pump running time	In Multipump system, at least one of the pump runtime counters has exceeded a user-defined fault limit	Carry out the needed maintenance actions, reset the runtime counter and reset the fault. (See ch. 4.15.4)
300	700	Unsupported	Unsupported application used.	Change the application
	701		Unsupported option board or slot used.	Remove the option board

10. APPENDIX 1

10.1 DEFAULT PARAMETER VALUES ACCORDING TO THE SELECTED APPLICATION

The default values of the following parameters vary according to the selected application wizard.

Table 134. Default parameter values according to application

Index	Parameter	Default					Unit	ID	Description
		Standard	HVAC	PID Control	Multipump (Single drive)	Multipump (Multidrive)			
P3.2.1	Remote control place	0	0	0	0	0		172	0 = I/O Control
P3.2.2	Local/remote	0	0	0	0	0		211	0 = Remote
P3.2.6	I/O A Logic	2	2	2	2	2		300	2 = Forw-Back (edge)
P3.2.7	I/O B Logic	2	2	2	2	2		363	2 = Forw-Back (edge)
P3.3.1.5	I/O A Reference Selection	6	6	7	7	7		117	6 = AI1 + AI2 7 = PID
P3.3.1.6	I/O B Reference Selection	4	4	4	4	4		131	4 = AI1
P3.3.1.7	Run time (text keypad)	2	2	2	2	2		121	2 = Keypad Reference
P3.3.1.10	Run time (text keypad)	3	3	3	3	3		122	3 = Fieldbus Reference
P3.3.3.1	Preset Frequency Mode	0	0	0	0	0		182	0 = Binary Coded
P3.3.3.3	Preset Frequency 1	10.0	10.0	10.0	10.0	10.0	Hz	105	
P3.3.3.4	Preset Frequency 2	15.0	15.0	15.0	15.0	15.0	Hz	106	
P3.3.3.5	Preset Frequency 3	20.0	20.0	20.0	20.0	20.0	Hz	126	
P3.3.6.1	Activate flushing reference	0	0	0	0	0		530	0 = not activated
P3.3.6.2	Flushing reference	0.0	0.0	0.0	0.0	50.0		1239	
P3.5.1.1	Ctrl Signal 1 A	100	100	100	100	100		403	
P3.5.1.2	Ctrl Signal 2 A	101	101	0	0	0		404	
P3.5.1.4	Ctrl Signal 1 B	0	0	103	101	0		423	
P3.5.1.7	I/O B Control Force	0	0	105	102	0		425	
P3.5.1.8	I/O B reference force	0	0	105	102	0		343	
P3.5.1.9	Fieldbus control force	0	0	0	0	0		411	
P3.5.1.10	Keypad control force	0	0	0	0	0		410	
P3.5.1.11	External Fault (Close)	102	102	101	0	105		405	
P3.5.1.13	Fault Reset (Close)	105	105	102	0	103		414	
P3.5.1.21	Preset Freq Selection 0	103	103	104	0	0		419	
P3.5.1.22	Preset Freq Selection 1	104	104	0	0	0		420	
P3.5.1.23	Preset Freq Selection 2	0	0	0	0	0		421	
P3.5.1.31	PID Setpoint Selection	0	0	0	0	102		1047	
P3.5.1.36	Flushing reference activation	0	0	0	0	101		530	

Table 134. Default parameter values according to application

P3.5.1.42	Pump 1 Interlock	0	0	0	103	0		426	
P3.5.1.43	Pump 2 Interlock	0	0	0	104	0		427	
P3.5.1.44	Pump 3 Interlock	0	0	0	105	0		428	
P3.5.2.1.1	AI1 Signal Selection	100	100	100	100	100		377	
P3.5.2.1.2	AI1 Filter Time	0.1	0.1	0.1	0.1	0.1	s	378	
P3.5.2.1.3	AI1 Signal Range	0	0	0	0	0		379	0 = 0...10V / 0...20 mA
P3.5.2.1.4	AI1 Custom Min	0.0	0.0	0.0	0.0	0.0		380	
P3.5.2.1.5	AI1 Custom Max	100.0	100.0	100.0	100.0	100.0		381	
P3.5.2.1.6	AI1 Signal Inversion	0	0	0	0	0		387	
P3.5.2.2.1	AI2 Signal Selection	101	101	101	101	101		388	
P3.5.2.2.2	AI2 Filter Time	0.1	0.1	0.1	0.1	0.1	s	389	
P3.5.2.2.3	AI2 Signal Range	1	1	1	1	1		390	1 = 2...10V / 4...20 mA
P3.5.2.2.4	AI2 Custom Min	0.0	0.0	0.0	0.0	0.0		391	
P3.5.2.2.5	AI2 Custom Max	100.0	100.0	100.0	100.0	100.0		392	
P3.5.2.2.6	AI2 Signal Inversion	0	0	0	0	0		398	
P3.5.3.2.1	RO1 Function	2	2	2	49	2		11001	2 = Run
P3.5.3.2.4	RO2 Function	3	3	3	50	3		11004	3 = Fault
P3.5.3.2.7	RO3 Function	1	1	1	51	1		11007	1 = Ready
P3.5.4.1.1	AO1 Function	2	2	2	2	2		10050	2 = Output Frequency
P3.5.4.1.2	AO1 Filter Time	1.0	1.0	1.0	1.0	1.0	s	10051	
P3.5.4.1.3	AO1 Min Signal	0	0	0	0	0		10052	
P3.5.4.1.4	AO1 Min Scale	0.0	0.0	0.0	0.0	0.0		10053	
P3.5.4.1.5	AO1 Max Scale	0.0	0.0	0.0	0.0	0.0		10054	
P3.13.2.5	PID Setpoint Selection	0	0	0	0	0		1047	
P3.13.2.6	PID Setpoint Source 1	-	-	3	3	3		332	3 = AI1
P3.13.2.10	PID Setpoint Source 2	-	-	-	-	1		431	1 = Keypad Setpoint 1
P3.13.3.1	PID Feedback Function	-	-	1	1	1		333	
P3.13.3.3	PID Feedback Source	-	-	2	2	2		334	
P3.15.1	Multipump Mode	-	-	-	0	2		1785	
P3.15.2	Number of Pumps	1	1	1	3	3		1001	
P3.15.5	Pump Interlocking	-	-	-	1	1		1032	
P3.15.6	Autochange	-	-	-	1	1		1027	
P3.15.7	Autochanged Pumps	-	-	-	1	1		1028	
P3.15.8	Autochange Interval	-	-	-	48.0	48.0	h	1029	
P3.15.11	Autochange Frequency Limit	-	-	-	25.0	50.0	Hz	1031	
P3.15.12	Autochange Pump Limit	-	-	-	1	3		1030	
P3.15.13	Bandwidth	-	-	-	10.0	10.0	%	1097	
P3.15.14	Bandwidth Delay	-	-	-	10	10	s	1098	
P3.15.15	Constant Production Speed	-	-	-	-	100.0	%	1513	

VACON[®]

DRIVEN BY DRIVES

Find your nearest Vacon office
on the Internet at:

www.vacon.com

Manual authoring:
documentation@vacon.com

Vacon Plc.
Runsorintie 7
65380 Vaasa
Finland

Subject to change without prior notice
© 2013 Vacon Plc.

Document ID:



Rev. B