

PROGRAMMABLE CONTROLLER
FP7 Positioning Unit
User's Manual

Safety Precautions

Observe the following notices to ensure personal safety or to prevent accidents.
To ensure that you use this product correctly, read this User's Manual thoroughly before use.
Make sure that you fully understand the product and information on safety.
This manual uses two safety flags to indicate different levels of danger.

WARNING

If critical situations that could lead to user's death or serious injury is assumed by mishandling of the product.

- Always take precautions to ensure the overall safety of your system, so that the whole system remains safe in the event of failure of this product or other external factor.
- Do not use this product in areas with inflammable gas. It could lead to an explosion.
- Exposing this product to excessive heat or open flames could cause damage to the lithium battery or other electronic parts.

CAUTION

If critical situations that could lead to user's injury or only property damage is assumed by mishandling of the product.

- To prevent excessive exothermic heat or smoke generation, use this product at the values less than the maximum of the characteristics and performance that are assured in these specifications.
- Do not dismantle or remodel the product. It could cause excessive exothermic heat or smoke generation.
- Do not touch the terminal while turning on electricity. It could lead to an electric shock.
- Use the external devices to function the emergency stop and interlock circuit.
- Connect the wires or connectors securely.
The loose connection could cause excessive exothermic heat or smoke generation.
- Do not allow foreign matters such as liquid, flammable materials, metals to go into the inside of the product. It could cause excessive exothermic heat or smoke generation.
- Do not undertake construction (such as connection and disconnection) while the power supply is on. It could lead to an electric shock.

Copyright / Trademarks

- This manual and its contents are copyrighted.
- You may not copy this manual, in whole or part, without written consent of Panasonic Industrial Devices SUNX Co., Ltd.
- Windows is a registered trademark of Microsoft Corporation in the United States and other countries.
- All other company names and product names are trademarks or registered trademarks of their respective owners.

Introduction

Thank you for buying a Panasonic product. Before you use the product, please carefully read the installation instructions and the users manual, and understand their contents in detail to use the product properly.

Types of Manual

- There are different types of users manual for the FP7 series, as listed below. Please refer to a relevant manual for the unit and purpose of your use.
- The manuals can be downloaded on our website:
http://industrial.panasonic.com/ac/e/dl_center/manual/

Unit name or purpose of use	Manual name	Manual code	
FP7 Power Supply Unit			
FP7 CPU Unit	FP7 CPU Unit Users Manual (Hardware)	WUME-FP7CPUH	
	FP7 CPU Unit Command Reference Manual	WUME-FP7CPUPGR	
	FP7 CPU Unit Users Manual (Logging Trace Function)	WUME-FP7CPULOG	
	FP7 CPU Unit Users Manual (Security Function)	WUME-FP7CPUSEC	
	Instructions for Built-in LAN Port	FP7 CPU Unit Users Manual (LAN Port Communication)	WUME-FP7LAN
		FP7 CPU Unit User's Manual (EtherNet/IP Communication)	-
		FP7 Web Server Function Manual	-
	Instructions for Built-in COM Port	FP7 series Users Manual (SCU communication)	WUME-FP7COM
	FP7 Extension Cassette (Communication) (RS-232C/RS485 type)		
	FP7 Extension Cassette (Communication) (Ethernet type)	FP7 series Users Manual (Communication cassette Ethernet type)	WUME-FP7CCET
FP7 Extension (Function) Cassette Analog Cassette	FP7 Analog Cassette Users Manual	WUME-FP7FCA	
FP7 Digital Input/Output Unit	FP7 Digital Input/Output Unit Users Manual	WUME-FP7DIO	
FP7 Analog Input Unit	FP7 Analog Input Unit Users Manual	WUME-FP7AIH	
FP7 Analog Output Unit	FP7 Analog Output Unit Users Manual	WUME-FP7AOH	
Thermocouple multi-analog input unit	Thermocouple multi-analog input unit RTD input unit Users Manual	WUME-FP7TCRTD	
RTD input unit			
FP7 High-speed counter Unit	FP7 High-speed counter Unit Users Manual	WUME-FP7HSC	
FP7 Pulse Output Unit	FP7 Pulse Output Unit Users Manual	WUME-FP7PG	
FP7 Positioning Unit	FP7 Positioning Unit Users Manual	WUME-FP7POSP	
FP7 Serial Communication Unit	FP7 series Users Manual (SCU communication)	WUME-FP7COM	
PHLS System	PHLS System Users Manual	WUME-PHLS	
Programming Software FPWIN GR7	FPWIN GR7 Introduction Guidance	WUME-FPWINGR7	

Table of Contents

1. Functions of Unit and Restrictions on Combinations.....	1-1
1.1 Functions of Positioning Unit	1-2
1.1.1 Functions of Unit	1-2
1.1.2 Unit Type	1-3
1.2 Restrictions on Combinations of Units	1-4
2. Names and Functions of Parts	2-1
2.1 Names and Functions of Parts.....	2-2
2.2 Operating Status LEDs.....	2-3
3. Wiring	3-1
3.1 Connection over Wire-pressed Terminal Cable	3-2
3.1.1 Specifications of Wire-pressed Terminal Cable	3-2
3.1.2 Assembly of Connector for Wire-pressed Terminal Cable.....	3-3
3.2 I/O Specifications and Terminal Wiring	3-4
3.2.1 I/O Specifications	3-4
3.3 Supply of Power to Drive Internal Circuit	3-8
3.3.1 Line Driver Output	3-8
3.3.2 Transistor Output.....	3-8
3.4 Connecting Pulse Instruction Signal Input	3-9
3.4.1 Line Driver Output Type	3-9
3.4.2 Transistor Output Type.....	3-9
3.5 Connecting Deviation Counter Clear Output Signal	3-10

3.6	Connecting Servo On Output Signal	3-11
3.7	Connecting Home Input/Near Home Input Signal.....	3-12
3.7.1	Connecting Home Input (Connecting Motor Driver Z-phase Output)....	3-12
3.7.2	Connecting Home Input (Connecting External Switch Sensor)	3-12
3.7.3	Connecting Near Home Input Signal.....	3-13
3.7.4	Connecting Limit Input Signal	3-13
3.8	Connecting Pulse Input.....	3-14
3.8.1	Line Driver Type	3-14
3.8.2	Transistor Open Collector Type	3-14
3.8.3	Transistor Resistance Pull-up Type	3-14
3.9	Wiring Cautions.....	3-15
4.	Power On/Off and Check Items	4-1
4.1	Safety Circuit Design.....	4-2
4.2	Before Turning On the Power.....	4-3
4.3	Procedure for Turning On the Power.....	4-5
4.3.1	Procedure for Turning On the Power	4-5
4.3.2	Procedure for Turning Off the Power	4-6
4.4	Check with Power Turned On	4-7
4.4.1	Check Items After Turning Power On	4-7
4.4.2	Check on External Safety Circuit	4-8
4.4.3	Check on Safety Circuit with Positioning Unit	4-8
4.4.4	Operation Checks on Near Home Switch and Home Switch.....	4-9
4.4.5	Checking Rotating and Moving Directions and Moving Distance	4-10
5.	Unit Allocation and Parameter Settings	5-1
5.1	Unit Allocation.....	5-2
5.1.1	I/O Map Registration	5-2
5.1.2	Check on I/O Allocation Information.....	5-3

Table of Contents

5.2	Axis Allocation for Use.....	5-5
5.2.1	Settings in Configurator PM7	5-5
5.3	Parameter Settings.....	5-7
5.3.1	Parameter Settings in Configurator PM7	5-7
5.3.2	Parameter Setting Items.....	5-8
5.4	Synchronous Parameter/Cam Pattern Settings	5-11
5.4.1	Synchronous Parameter Settings	5-11
5.4.2	Cam Pattern Settings	5-12
5.5	Creating Positioning Data Table	5-13
5.5.1	Construction of Positioning Data Table.....	5-13
5.5.2	Table No. Positioning Start.....	5-14
5.5.3	Operation Patterns and Tables	5-15
5.6	Saving Parameters	5-16
5.6.1	Saving and Loading of Configuration	5-16
6.	Transfer to Unit and Commissioning	6-1
6.1	Check on Setting Contents	6-2
6.1.1	Check on Parameter Data.....	6-2
6.1.2	Comparison of Parameter Information	6-2
6.2	Transfer of Parameters.....	6-4
6.2.1	Writing Parameters to CPU Unit	6-4
6.3	Monitoring on Configurator PM7	6-5
6.3.1	Status Monitor	6-5
6.3.2	Data Monitor	6-5
6.4	Tool Operation.....	6-8
6.4.1	Tool Operation Function.....	6-8
6.4.2	Serve ON/OFF with Tool Operation Function	6-9
6.4.3	JOG Operation with Tool Operation Function	6-10
6.4.4	Home Return by Tool Operation Function	6-12
6.4.5	Positioning by Tool Operation Function	6-14

6.4.6 Teaching by Tool Operation Function6-17

7. Automatic Operation (Positioning Control)..... 7-1

7.1 Basic Operation 7-2

7.1.1 Positioning Control Patterns..... 7-2

7.1.2 Setting and Operation of E-point Control 7-4

7.1.3 Setting and Operation of P-point Control 7-5

7.1.4 Setting and Operation of C-point Control 7-6

7.1.5 Setting and Operation of J-point Control..... 7-7

7.1.6 Sample Program (E-point, P-point, and C-point Control)..... 7-9

7.1.7 Sample Program (J-point Control) 7-9

7.1.8 Programming Precautions..... 7-10

7.2 Interpolation Control..... 7-11

7.2.1 Types of Interpolation Control 7-11

7.2.2 Setting and Operation of 2-Axis Linear Interpolation 7-14

7.2.3 Setting and Operation of 2-Axis Circular Interpolation..... 7-16

7.2.4 Setting and Operation of 3-Axis Linear Interpolation 7-19

7.2.5 Setting and Operation of Three-Axis Linear Interpolation..... 7-21

7.2.6 Sample Program (Interpolation Control) 7-23

7.3 Setting and Operation of Positioning Repeat Function 7-24

8. Automatic Operation (Synchronous Control) 8-1

8.1 Synchronous Control..... 8-2

8.1.1 Outline of Synchronous Control 8-2

8.2 Settings for Master and Slave Axes 8-3

8.2.1 Selection of Master Axis and Settings 8-3

8.2.2 Selection of Slave Axes and Settings 8-4

8.3 Start and Cancel of Synchronous Control 8-5

8.3.1 Start and Cancel of Synchronous Control..... 8-5

8.3.2 Precautions When Canceling or Starting Synchronous Control 8-7

Table of Contents

8.4	Electronic Gear Function	8-11
8.4.1	Outline of Electronic Gear Function	8-11
8.4.2	Types and Contents of Setting Parameters	8-12
8.4.3	Gear Ratio Changes while in Operation.....	8-13
8.5	Electronic Clutch Function	8-15
8.5.1	Electronic Clutch Function.....	8-15
8.5.2	Types and Contents of Setting Parameters	8-16
8.5.3	Trigger Types for Electronic Clutch	8-17
8.5.4	Engagement Methods of Electronic Clutch	8-18
8.5.5	Phase Specification Clutch Off Function.....	8-19
8.6	Electronic Cam Function.....	8-21
8.6.1	Outline of Electronic Cam Function.....	8-21
8.6.2	Types and Contents of Setting Parameters	8-23
8.6.3	Cam Pattern Setting Method	8-24
8.6.4	Editing Cam Patterns by User Programs	8-31
8.6.5	Advance Angle Correction Function.....	8-38
9.	Manual Operation (JOG Operation)	9-1
9.1	Setting and Operation of JOG Operation	9-2
9.2	Changing the Speed During JOG Operation.....	9-4
10.	Manual Operation (Home Return)	10-1
10.1	Pattern of Home Return.....	10-2
10.2	Setting and Operation of Home Return.....	10-5
11.	Manual Operation (Pulser Operation)	11-1
11.1	Setting and Operation of Pulser Operation	11-2

12. Stop Functions	12-1
12.1 Types and Settings of Stop Function.....	12-2
12.1.1 Type of Stop Operations	12-2
12.1.2 Stop time settings.....	12-4
12.2 Operation During Stop	12-5
12.3 Pause function	12-6
12.3.1 Pause Function	12-6
12.3.2 Setting of Pause	12-7
13. Supplementary Functions.....	13-1
13.1 Dwell Time	13-2
13.2 Software Limit	13-3
13.3 Auxiliary Output Code and Auxiliary Output Contact	13-4
13.4 Current Value Update	13-6
13.5 Coordinate Origin.....	13-8
13.6 Pulse Input.....	13-9
13.6.1 Pulse Input Types.....	13-9
13.6.2 Restrictions on Combinations of Pulse Inputs	13-10
13.6.3 Input Mode to Pulse Input	13-11
13.6.4 Monitoring Pulse Input Values	13-13
13.6.5 Pulser Input Function	13-14
13.6.6 Feedback Pulse Function.....	13-14
13.6.7 High-speed Counter Function	13-18
13.7 Startup speed	13-20
13.8 Target Speed Change Function (For unit version Ver.1.3 or later only).....	13-21
13.8.1 Function Explanation.....	13-21
13.8.2 Setting Procedures and Operations (Speed Direct Specification Method).....	13-23
13.8.3 Setting Procedures and Operations (Ratio Specification Method)	13-27

13.9 Movement Amount Change Function (For unit version Ver.1.3 or later only) 13-29

- 13.9.1 Function Explanation..... 13-29
- 13.9.2 Setting Procedures and Operations 13-30

14. Programming Cautions..... 14-1

14.1 Programming Cautions 14-2

- 14.1.1 Turning Off Power Supply Clears Contents of Unit Memory..... 14-2
- 14.1.2 Not Going to Other Operation from Current Operation 14-2
- 14.1.3 Operation with the PLC Set to PROG. Mode from RUN Mode..... 14-2
- 14.1.4 Types of Positioning Data Setting Areas..... 14-3

15. Errors and Warnings..... 15-1

15.1 About Errors and Warnings 15-2

- 15.1.1 Errors and Warnings 15-2
- 15.1.2 Check and Clearing with Configurator PM7 15-2
- 15.1.3 Check and Clearing with User Program 15-3
- 15.1.4 Error and Warning Logs 15-4

15.2 Changes in Recovery from Errors..... 15-5

- 15.2.1 Outline 15-5

15.3 Error Code Table 15-6

- 15.3.1 System Error (from 1000H) 15-6
- 15.3.2 Axis operation error (from 3000H)..... 15-7
- 15.3.3 Set Value Error (from 4000H) 15-9
- 15.3.4 Synchronous Parameter Setting Error (from 5000H) 15-14

15.4 List of Warning Codes 15-17

- 15.4.1 Unit Warning (from B000H) 15-17

16. Troubleshooting	16-1
16.1 What to Do If an Error Occurs	16-2
16.1.1 Motor is not Rotating or Operating (Pulse Output A and B LEDs are Flashing or Lit).....	16-2
16.1.2 Motor is not Rotating or Operating (Pulse Output A and B LEDs are Off).....	16-2
16.1.3 Reversed Rotation or Movement Direction	16-3
17. Specifications	17-1
17.1 Specifications.....	17-3
17.1.1 General Specifications	17-3
17.1.2 Performance Specifications	17-4
17.2 I/O Number Allocation	17-7
17.3 Entire Configuration of Memory Unit Area	17-15
17.4 Details of Common Area in Unit Memory	17-17
17.4.1 Common Area Configuration.....	17-17
17.4.2 Setting Parameter Control Area	17-18
17.4.3 Operating Speed Factor Area	17-18
17.4.4 Axis Group Setting Area.....	17-18
17.4.5 Current Value Update Data Area	17-19
17.4.6 Positioning Control Starting Table Number Setting Area.....	17-20
17.4.7 Positioning Control Area	17-20
17.4.8 Error Annunciation & Clear Area.....	17-21
17.4.9 Warning Annunciation & Clear Area	17-23
17.4.10 Pulse Count Control Area.....	17-25
17.4.11 Synchronous Control Monitor Area	17-26
17.4.12 System Operation Setting Area.....	17-27
17.5 Details of Each Axis Information Area in Unit Memory	17-28
17.5.1 Each Axis Information & Monitor Area	17-28
17.5.2 Each Axis Information & Monitor Area	17-29
17.6 Details of Each Axis Setting Area in Unit Memory	17-32

Table of Contents

17.6.1 Configuration of Each Axis Setting Area	17-32
17.6.2 Positioning Parameter Setting Area	17-33
17.6.3 Positioning Data Setting Areas	17-43
17.7 Unit Memory Synchronous Control Setting Area.....	17-64
17.7.1 Synchronous Control Setting Area	17-64
17.7.2 Detailed Information on Synchronous Control Setting Area	17-65
17.8 Positioning Operation Change Setting Area.....	17-74
17.8.1 Positioning Speed/Movement Amount Change Parameter	17-74
17.9 Cam Pattern Editing Area	17-77
17.9.1 Cam Pattern Setting Area	17-77
17.9.2 Cam Pattern Editing Execution Confirmation Area	17-80
17.10Dimensions.....	17-82
18. Sample program.....	18-1
18.1 Basic Configuration and Contact Allocations of Sample Programs	18-2
18.2 Sample program.....	18-4
18.2.1 When Settings Done in Standard Area with Programming tool	18-4
18.2.2 When Setting Positioning Data in Extended Area by Programming	18-7
18.2.3 When Setting Positioning Data in Standard Area by Programming.....	18-9

1

Functions of Unit and Restrictions on Combinations

1.1 Functions of Positioning Unit

1.1.1 Functions of Unit

- The positioning unit can perform positioning control when it is used in combination with a stepping motor or servomotor equipped with a driver of pulse string input type.

Positioning control with stepping motor

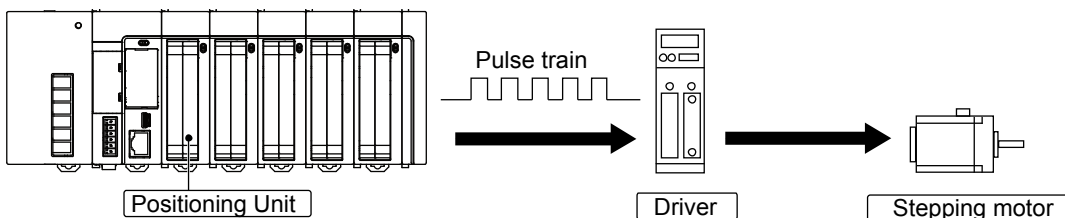

Positioning control with servomotor

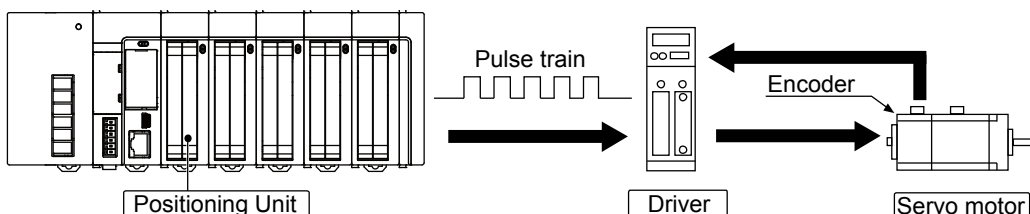

- **Transistor output (open collector) type and line driver output type available**

Two types are available—a line driver output type for high-speed control and a transistor output type for a motor equipped with a driver that connects only to open collector output (e.g., a stepping motor). If either type is applicable to your application, the use of the unit with line driver output is recommended.

- **Setting in configuration menu**

The dedicated software Configurator PM7 is available, which allows ease of creating a variety of parameters and positioning tables required for positioning control.

Note) "Configurator PM7" is started from the "Option" menu of FPWIN GR7.

- **Interpolation control**

The 2-axis linear interpolation, 2-axis circular interpolation, 3-axis linear interpolation, and 3-axis spiral interpolation control can be performed.

- **Synchronous control**

The unit supports synchronous control using an electronic gear, electronic clutch, and electronic cam. The unit can perform synchronous control with an actual or virtual axis as a master axis.

1.1.2 Unit Type

■ Product type

Type	Product no.
2-axis transistor	AFP7PP02T
2-axis line driver	AFP7PP02L
4-axis transistor	AFP7PP04T
4-axis line driver	AFP7PP04L

1.2 Restrictions on Combinations of Units

When the system is configured, take the other units being used into consideration and use a power supply unit with a sufficient capacity.

■ Current consumption

Type	Product no.	Current consumption
2-axis transistor	AFP7PP02T	120 mA
2-axis line driver	AFP7PP02L	120 mA
4-axis transistor	AFP7PP04T	120 mA
4-axis line driver	AFP7PP04L	120 mA

2

Names and Functions of Parts

2.1 Names and Functions of Parts

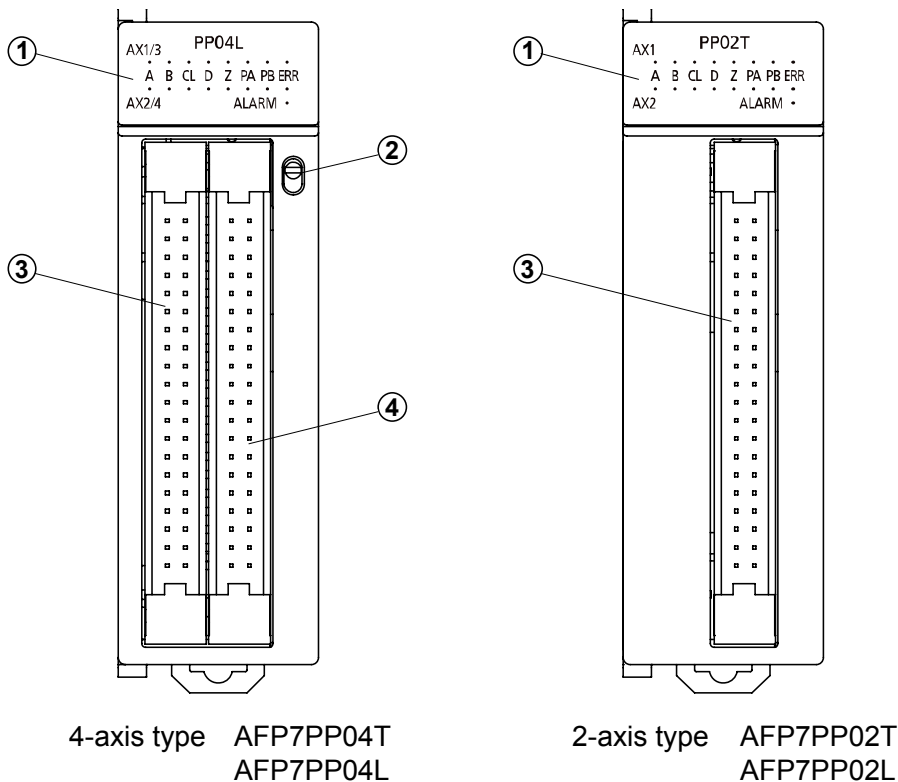

① Operation monitor LEDs

Displays the operating status of two axes.

② Operating monitor switch (AFP7PP04T and AFP7PP04L only)

Toggles between the operating status display of 1st and 2nd axes and that of the 3rd and 4th axes.

③ User I/F connector (1st axis and 2nd axis)

A connector for a motor driver and external interface.

④ User I/F connector (3rd axis and 4th axis) (AFP7PP04T and AFP7PP04L only)

A connector for a motor driver and external interface.

2.2 Operating Status LEDs

The LEDs display the operating status of two axes at a time. If the unit is of 4-axis type, use the switch to toggle between the operating status display of the 1st and 2nd axes and that of the 3rd and 4-axes. The contents of the LED display are the same in each axis.

Operation monitor LEDs

LED	Description		Color	ON	OFF	Flashing
A	Pulse output A-signal display (note 1)	With pulse/sign output settings	Green	– (note 4)	Not in operation	Pulse output
		With CW/CCW output settings	Green	– (note 4)	Not in operation (forward rotation)	In pulse output operation (forward rotation)
B	Pulse output B-signal display (note 1)	With pulse/sign output settings	Green	Reverse rotation instruction	Forward rotation instruction	–
		With CW/CCW output settings	Green	–	Not in operation (reverse rotation)	In pulse output operation (reverse rotation)
CL	Displays counter clear signal output		Green	Output ON	Output OFF	–
D	Displays near home state (note 2)		Green	ON	OFF	–
Z	Displays home input state (note 2)		Green	ON	OFF	–
PA	Pulse input A-signal display (note 3)		Green	Displays the input status of pulse input A-signal		
PB	Pulse input B-signal display (note 3)		Green	Displays the input status of pulse input B-signal		
ERR	Displays the occurrence of error or warning		Red	If an error occurs	Normal operation	If a warning occurs
ALARM	Displays hardware error		Red	If a hardware error occurs	Normal operation	–

(Note 1): The LED for the pulse output A-signal flashes at a cycle (speed) of output frequency, thus looking as if it were continuously lit if the speed is high. So is the LED for the pulse output B-signal.

(Note 2): Near home input (D) and home input (Z) will be lit if the respective inputs are enabled.

(Note 3): The input status of pulse input signals (PA) and (PB) will be displayed.

(Note 4): The LEDs may be continuously lit with or without pulse output if the electronic clutch or electronic cam is in operation.

3

Wiring

3.1 Connection over Wire-pressed Terminal Cable

3.1.1 Specifications of Wire-pressed Terminal Cable

This is a connector that allows loose wires to be connected without removing the wires' insulation. The pressure connection tool is required to connect the loose wires.

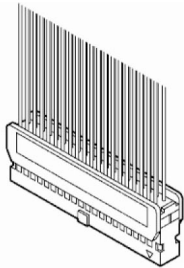

Discrete-wire connector (40P)

Suitable wires (strand wire)

Size	Nominal cross-sectional area	Insulation thickness	Rated current
AWG#22	0.3 mm ²	1.5 to 1.1 dia.	3 A
AWG#24	0.2 mm ²		

Connector for wire-pressed terminal cable (provided with the unit)

Manufacturer	Composition of parts	Unit type and required quantity	
		2-axis type	4-axis type
Panasonic made	Housing (40P)	1 x 1 set	1 x 2 sets
	Semi-cover (40P)	2 x 1 set	2 x 2 sets
	5-pin contact (for AW22 and AW24)	8 x 1 set	8 x 2 sets

(Note): One set is provided for the 2-axis type and two sets are provided for the 4-axis type. If you need more connectors, purchase AFP2801 (2 sets/pack).

Pressure connection tool

Manufacturer	Product no.
Panasonic made	AXY52000FP

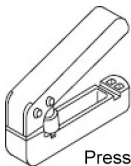

Pressure connection tool

3.1.2 Assembly of Connector for Wire-pressed Terminal Cable

The wire end can be directly crimped without removing the wire's insulation, which saves wiring effort.

(Procedure)

1. Bend the contact back from the carrier, and set it in the pressure connection tool.



2. Insert the wire without removing its insulation until it stops, and lightly grip the tool.



3. After press fitting the wire, insert it into the housing.

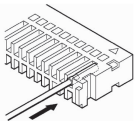

4. When all wires have been inserted, fit the semi-cover into place.

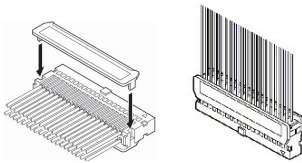

◆ KEY POINTS

- **Contact puller pin to redo wiring**
If there is a wiring mistake or the wire is incorrectly pressure-connected, use the contact puller pin provided with the fitting to remove the contact.

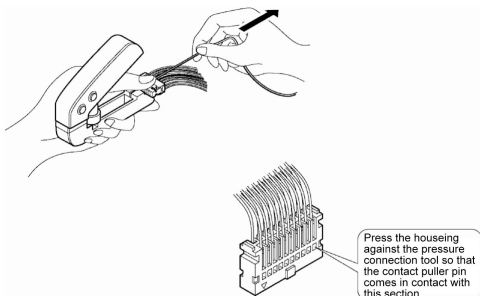

3.2 I/O Specifications and Terminal Wiring

3.2.1 I/O Specifications

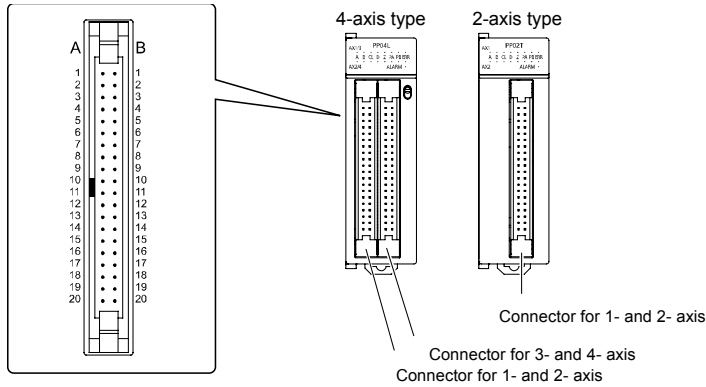

The 4-axis type and 2-axis type use two connectors and one connector, respectively. Signal pins for two axes are allocated to a single connector. There is no difference in pin arrangement between the AX1 and AX2 connector and the AX3 and AX4 connector if the unit is of the 4-axis type. Any pins with the same in number have the same function. The transistor type and line driver type are the same in input terminal and power terminal specifications. Only the performance of the pulse output terminal of the transistor type and that of the line driver type are different from each other.

Output terminal (transistor output type)

Pin no.		Circuit	Signal name		Items	Description
1st/ 3rd axis	2nd/ 4th axis					
A1	A10	<p>5 V</p> <p>A1/A10 A2/A11</p> <p>B1/B10 B2/B11</p>	Pulse output A: 5 V DC output	Output specifications	Output type	Open collector
B1	B10		Pulse output A: Open collector		Operating voltage range	4.75 to 26.4 V DC
A2	A11		Pulse output B: 5 V DC output		Max. load current	15 mA
B2	B11		Pulse output B: Open collector		ON-state voltage drop	0.6 V

Output terminal (line driver output type)

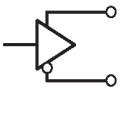

Pin no.		Circuit	Signal name		Items	Description
1st/ 3rd axis	2nd/ 4th axis					
A1	A10		Pulse output A: Line driver (+)	Output specifications	Output type	Line driver output AM26C31 or equivalent
B1	B10		Pulse output A: Line driver (-)			
A2	A11		Pulse output B: Line driver (-)			
B2	B11		Pulse output B: Line driver (-)			

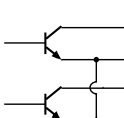
Output terminal (common)

Pin no.		Circuit	Signal name		Items	Description
1st/ 3rd axis	2nd/ 4th axis					
A7	A16		Deviation counter clear	Output specifications	Output type	Open collector
B7	B16		COM		Operating voltage range	4.75 to 26.4 V DC
B5	B14		Servo ON		Max. load current	10 mA
			ON-state voltage drop		1.0 V	

(Note): The deviation counter clear signal will be output for 1 ms on completion of home return control.

Power supply terminal (common)

Pin no.	Circuit	Signal name		Items	Description
A20		External power supply input: 24 V DC (+)	Power supply specifications	Supply power range	21.4 to 26.4 V DC
B20		External power supply input: 24 V DC (-)		Current consumption	4-axis type 90 mA max. 2-axis type 50 mA max.

(Note): In the case of the 4-axis type, the external power supply input terminals of the two connectors are connected internally.

Input terminal (common)

Pin no.		Circuit	Signal name		Items	Description	
1st/ 3rd axis	2nd/ 4th axis						
A3	A12		Home input 24 V DC (+) (Z24)	Input specifications	Operating voltage range	21.6 to 26.4 V DC	
					Minimum ON voltage/current	19.2 V DC/5.5 mA	
					Maximum OFF voltage/current	2 V DC/2 mA	
					Input impedance	Approx. 3.9 kΩ	
					Minimum input pulse width	100 μs or over	
A4	A13		Home input 5 V DC (+) (Z5)	Input specifications	Operating voltage range	3.5 to 5.25 V DC (5 V DC, line driver specifications)	
					Minimum ON voltage/current	3 V DC/4 mA	
					Maximum OFF voltage/current	1 V DC/0.5 mA	
					Input impedance	Approx. 560 Ω	
					Minimum input pulse width	100 μs or over	
B3	B12		Home input (-)	-	-	-	
B4	B13		COM	-	-	-	
A5	A14		Near home input (DOG)	Input specifications	Operating voltage range	21.6 to 26.4 V DC	
					Minimum ON voltage/current	Near home input (DOG) 19.2 V DC/5.0 mA Limit (+) input (Limit +) Limit (-) input (Limit -) 19.2 V DC/2.6 mA	
A6	A15				Limit (+) input (Limit +)	Maximum OFF voltage/current	2 V DC/1.5 mA
B6	B15				Limit (-) input (Limit -)	Input impedance	Near home input (DOG) Approx. 3.6 kΩ Limit (+) input (Limit +) Limit (-) input (Limit -) Approx. 6.8 kΩ
						Minimum input pulse width	500 μs or over

Pin no.		Circuit	Signal name	Items	Description	
1st/ 3rd axis	2nd/ 4th axis					
A8	A17		Pulse input A (+)	Input specifications	Operating voltage range	3.5 to 5.25 V DC (5 V DC, line driver specifications)
B8	B17		Pulse input A (-)		Minimum ON voltage/current	3 V DC/3.2 mA
A9	A18		Pulse input B (+)		Maximum OFF voltage/current	1 V DC/0.5 mA
B9	B18		Pulse input B (-)		Input impedance	Approx. 560 Ω
					Minimum input pulse width	0.5 μs or over (1 MHz max. on each phase)

Note: Use pulse input signals A and B within the following specifications.

■ Using pulse input A and B for 2-phase input.

Pulsed input is used for 2-phase input.

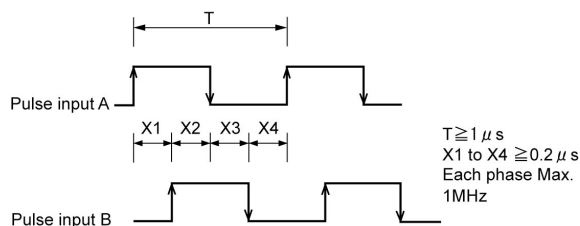

■ Using pulse input A and B for direction discrimination input.

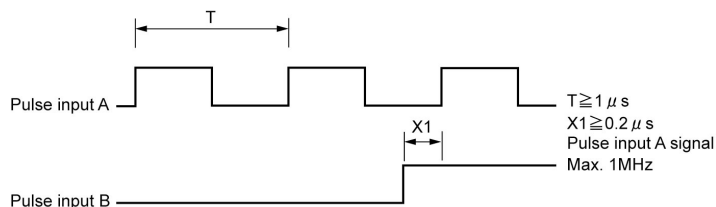

■ Using pulse input A and B for individual input.

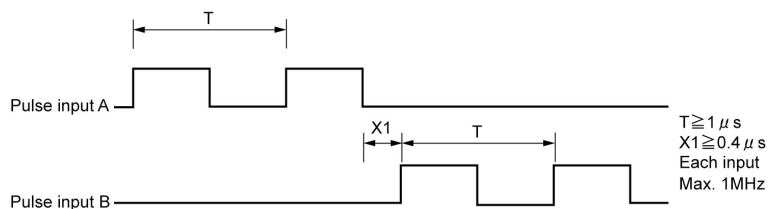

3.3 Supply of Power to Drive Internal Circuit

3.3.1 Line Driver Output

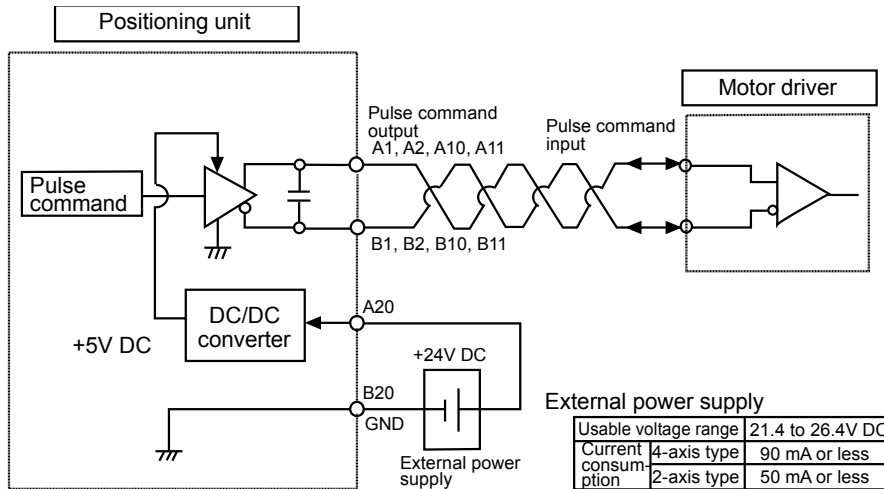

The illustration shows one signal component extracted from the overall configuration.

3.3.2 Transistor Output

It is possible to get power for the pulse instruction output circuit from the 5-V DC output terminal (pins A1, A2, A10, and A11).

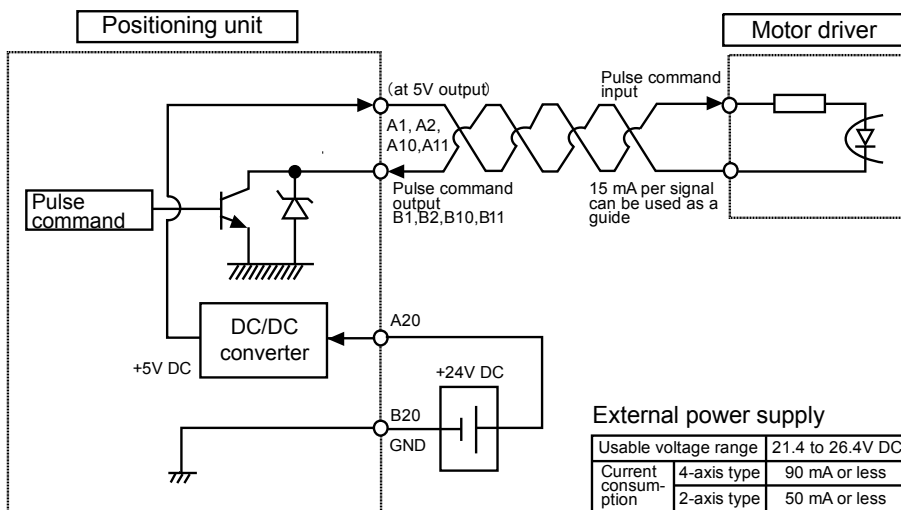

Note:

Make sure that a current not in excess of 15 mA is provided for each signal in the case of using pulse transistor output (open collector output). Add appropriate resistance if the current exceeds 15 mA.

3.4 Connecting Pulse Instruction Signal Input

3.4.1 Line Driver Output Type

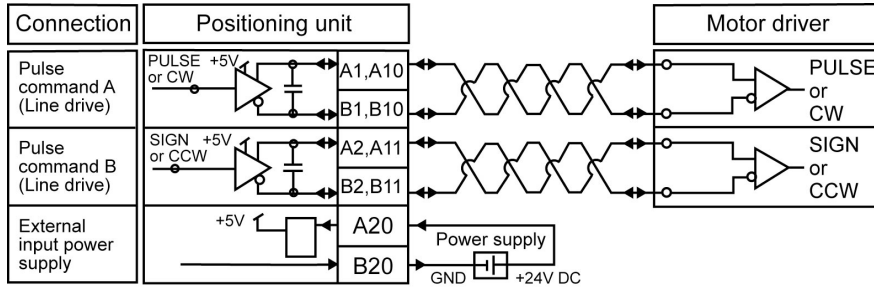

3.4.2 Transistor Output Type

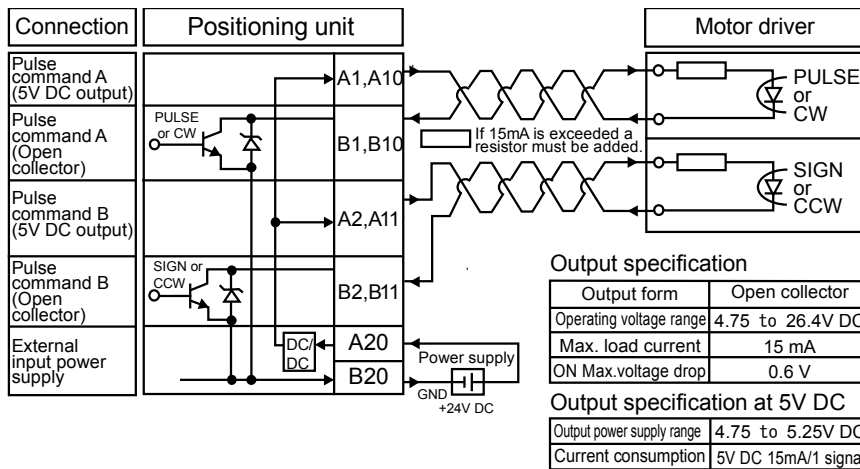

Note:

Make sure that a current not in excess of 15 mA is provided for each signal. Add appropriate resistance if the current is in excess.

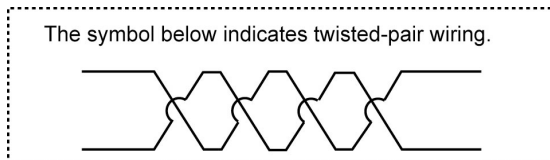

KEY POINTS

- The use of a twisted-pair cable is recommended to connect the output of the positioning unit and the motor driver.

3.5 Connecting Deviation Counter Clear Output Signal

The following diagram shows an example of connection to the counter clear input of the serve motor driver. This connection requires an external power supply of 5 to 24 V DC.

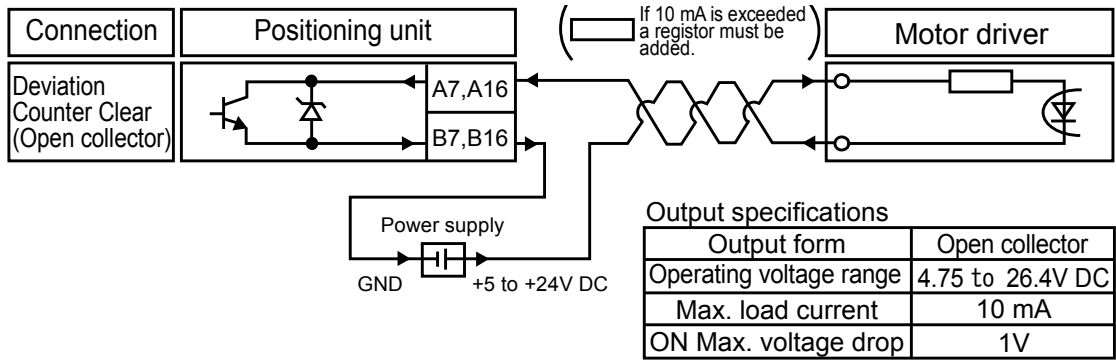

Note:

- Be sure to use a twisted-pair cable.
- A maximum of 10 mA can flow as a deviation counter clear output signal. Add appropriate resistance if the current is in excess.

3.6 Connecting Servo On Output Signal

The following diagram shows an example of connection to the servo on of the servo motor driver. This connection requires an external power supply of 5 to 24 V DC.

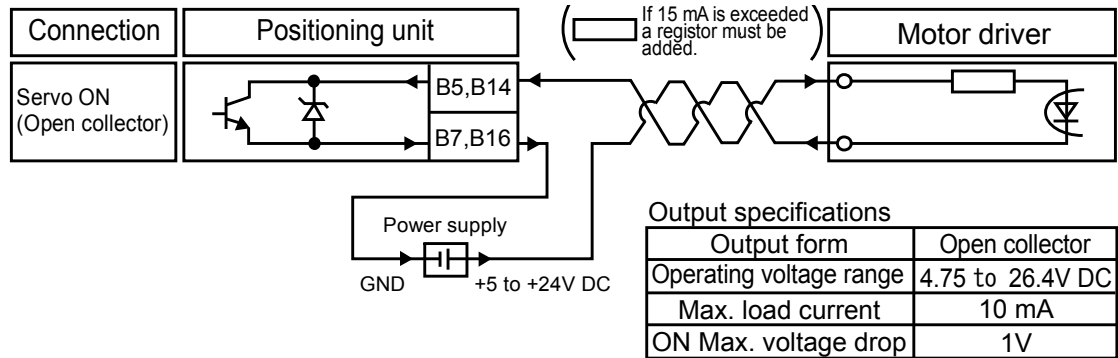

Note:

- Be sure to use a twisted-pair cable.
- A maximum of 10 mA can flow as a servo ON output signal. Add appropriate resistance if the current is in excess.

3.7 Connecting Home Input/Near Home Input Signal

3.7.1 Connecting Home Input (Connecting Motor Driver Z-phase Output)

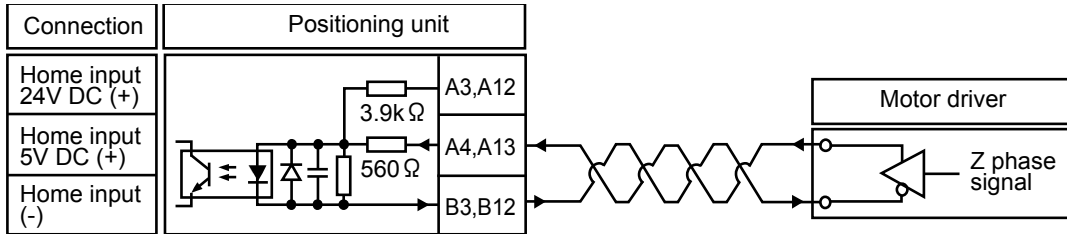

Input specifications (at 5V DC)

Input voltage range	3.5 to 5.25V DC
Min. ON voltage/current	3V DC/4mA
Max. OFF voltage/current	1V DC/0.5mA
Input impedance	Approx. 560Ω
Min. input pulse width	100 μs



◆ KEY POINTS

- The use of a twisted-pair cable is recommended to connect the output of the positioning unit and the motor driver.

3.7.2 Connecting Home Input (Connecting External Switch Sensor)

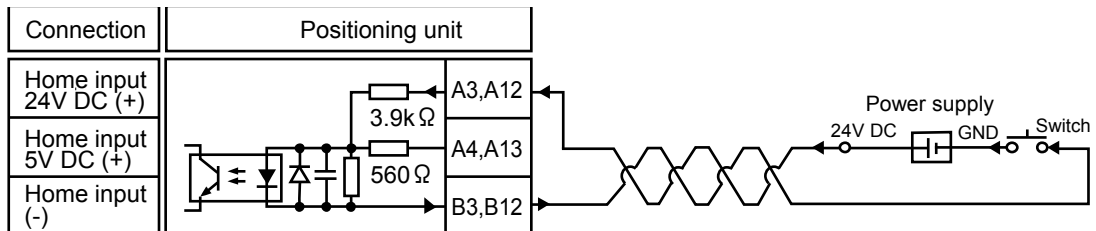

Input specifications (at 24V DC)

Input voltage range	21.6~26.4V DC
Min. ON voltage/current	19.2V DC/5.5mA
Max. OFF voltage/current	2V DC/2mA
Input impedance	Approx. 3.9kΩ
Min. input pulse width	100 μs

3.7.3 Connecting Near Home Input Signal

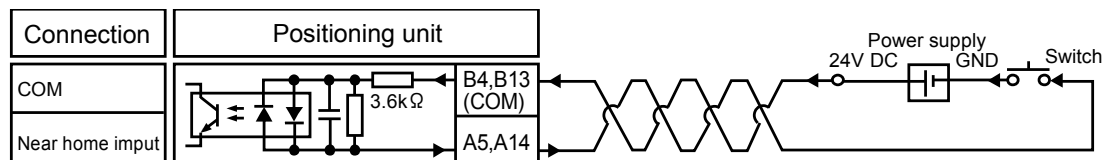

Input specifications

Input voltage range	21.6 to 26.4V DC
Min. ON voltage/current	19.2V DC/5.0mA
Max. OFF voltage/current	2V DC/1.5mA
Input impedance	Approx. 3.6kΩ
Min. input pulse width	500 μs

(Note): B4 and B13 are common to near home input, limit (+) input, limit (-) input, and positioning control start input (timing input).

3.7.4 Connecting Limit Input Signal

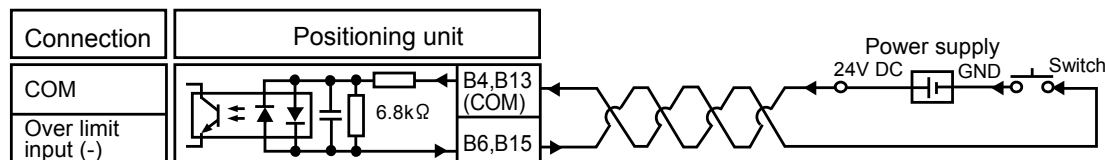
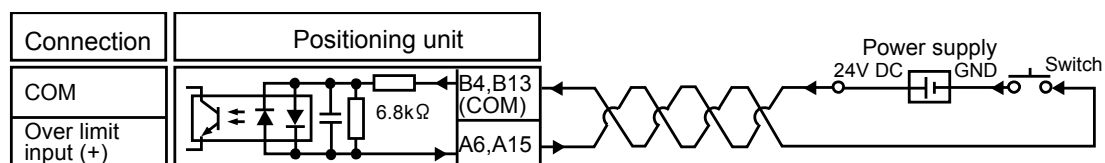

Input specifications

Input voltage range	21.6~26.4V DC
Min. ON voltage/current	19.2V DC/2.6mA
Max. OFF voltage/current	2V DC/1.5mA
Input impedance	Approx. 6.8kΩ
Min. input pulse width	500 μs

(Note): B4 and B13 are common to near home input, limit (+) input, and limit (-) input.

3.8 Connecting Pulse Input

3.8.1 Line Driver Type

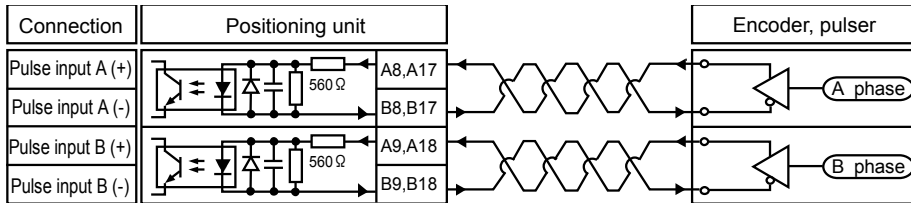

3.8.2 Transistor Open Collector Type

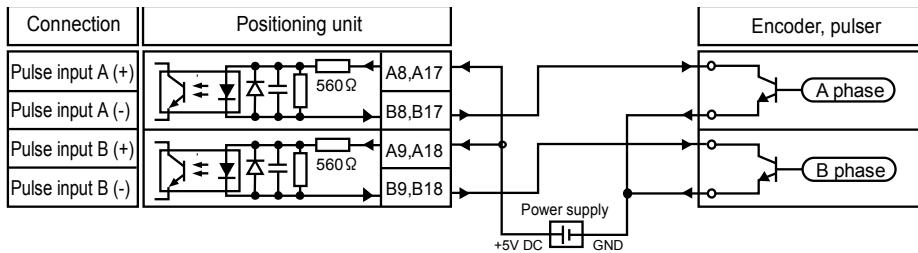

3.8.3 Transistor Resistance Pull-up Type

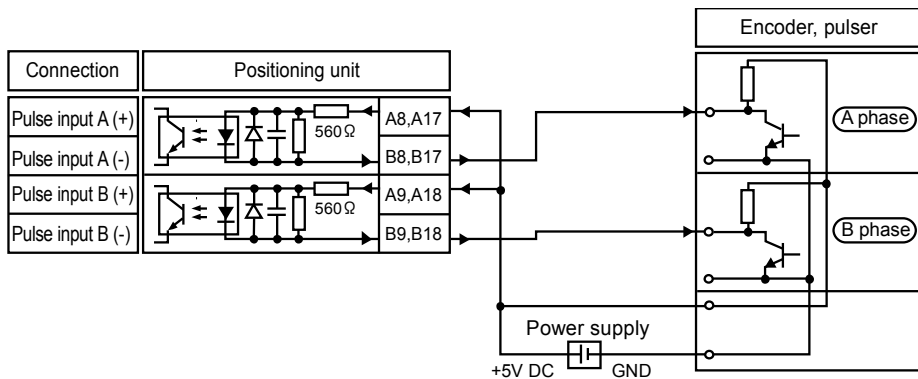

◆ KEY POINTS

The pulser input operation and feedback pulse count of the unit uses the same pulse input terminal. Therefore, select either one of them.

- The use of a twisted-pair cable is recommended.
- In the case of counting 2-phase inputs, such as encoder inputs, use a control code and set the pulse input count to x4 or x2 for the prevention of counting errors.

3.9 Wiring Cautions

Connect the transistor output type or line driver output type to the motor driver over twisted-pair cable within the following wiring distance.

<Signals supported>

- Transistor output
- Line driver output
- Deviation counter clear output

Output type	Model no.	Wiring distance
Transistor output type	AFP7PP02T	10 m
	AFP7PP04T	
Line driver output type	AFP7PP02L	
	AFP7PP04L	

4

Power On/Off and Check Items

4.1 Safety Circuit Design

Example of a safety circuit

Installation of the over limit switch

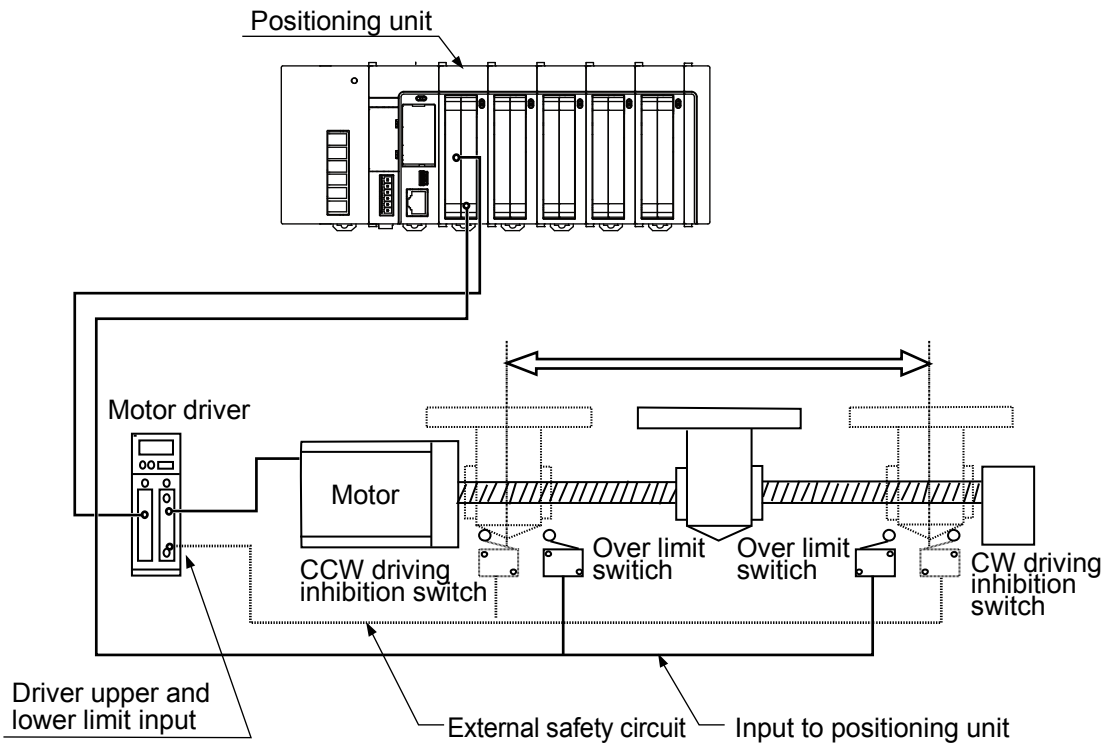

Safety Circuit with Positioning Unit

Install over limit switches as shown above.

Connect the switch to the limit (+) input and limit (-) input of the positioning unit.

External safety circuit

Install the safety circuit recommended by the manufacturer of the motor being used.

4.2 Before Turning On the Power

■ Check items before turning on the power

System configuration example

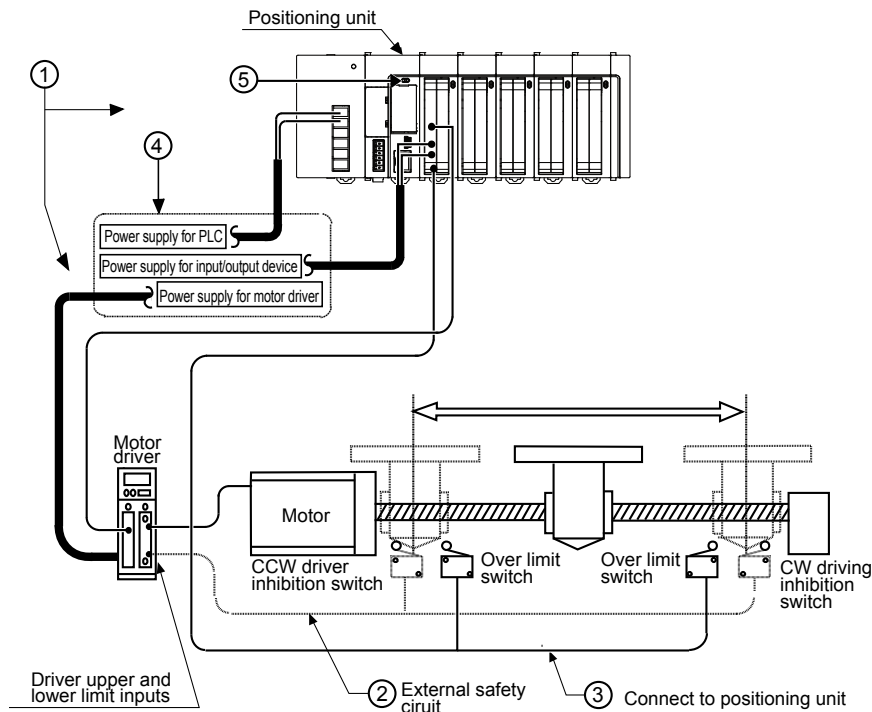

(1) Checking connections to the various devices

Check and make sure the various devices have been connected as indicated by the design.

(2) Checking the installation of the external safety circuit

Check and make sure the safety circuit (wiring and installation of over limit switch) based on an external circuit has been installed securely.

(3) Checking the safety circuit with the positioning unit

Check the connections of the positioning unit and over limit switch.
Check the installation condition of the over limit switch.

(4) Checking the procedure settings for turning on the power supplies

Make sure settings have been entered so that power supplies will be turned on according to the procedure outlined in section "Procedure for Turning On the Power".

(5) Checking the CPU mode selection switch

Set the CPU unit to PROG. Mode. The CPU unit in RUN mode may operate unexpectedly.



◆ **NOTE**

- **The use of the positioning unit requires configuration menu settings. Check that each parameter is set properly.**

4.3 Procedure for Turning On the Power

4.3.1 Procedure for Turning On the Power

When turning on the power to the system incorporating the positioning unit, consider the nature and statuses of any external devices connected to the system, and take sufficient care so that turning on the power will not initiate unexpected movements.

Procedure

1. Turn on the power supplies for input and output devices connected to the PLC.
(The power supplies include those for line driver output or open collector output.)
2. Turn on the power supply to the PLC.
3. Turn on the power supply to the motor driver.

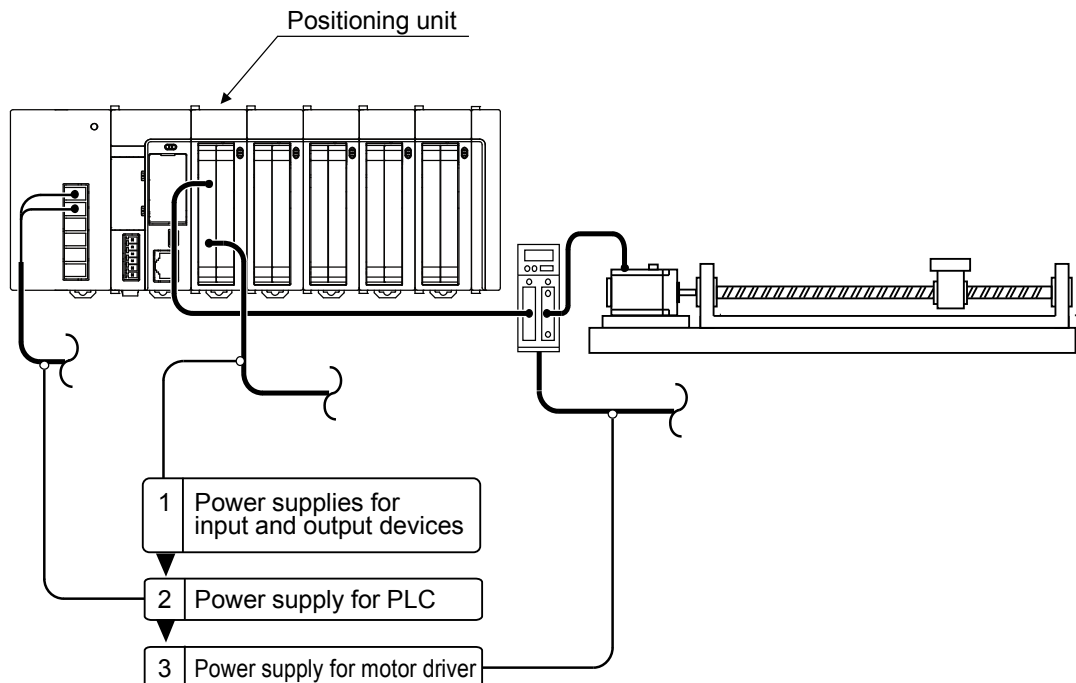

4.3.2 Procedure for Turning Off the Power

Procedure

1. Check and make sure the rotation of the motor has stopped, and then turn off the power supply for the PLC.
2. Turn off the power supply to the PLC.
3. Turn off the power supplies for input and output devices connected to the PLC.
(The power supplies include those for line driver output or open collector output.)

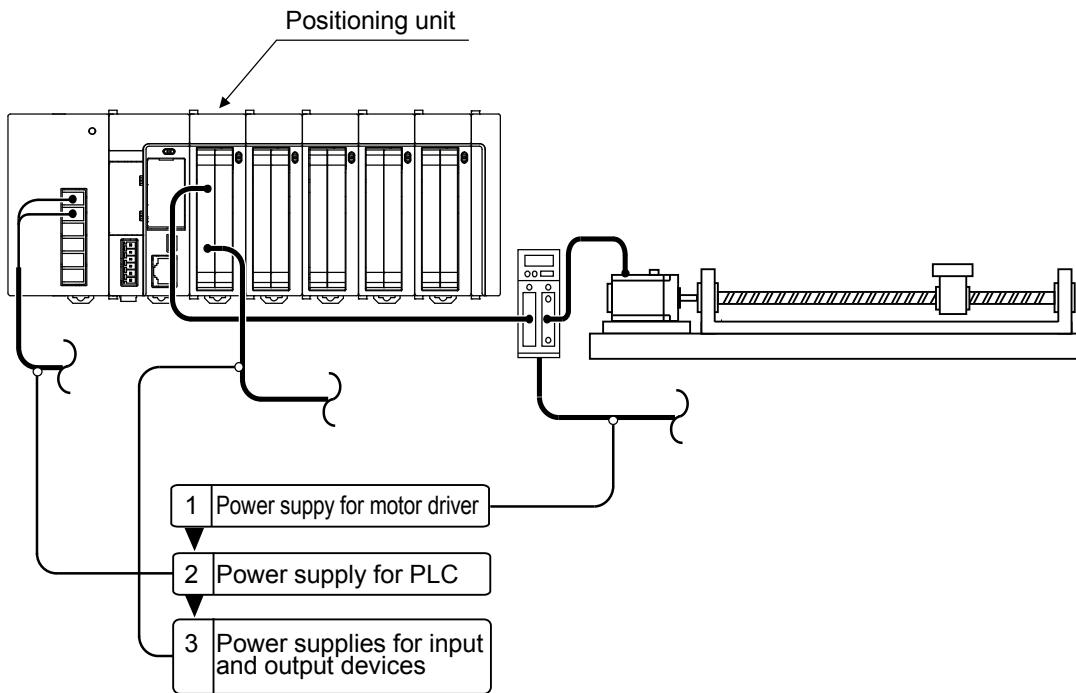

4.4 Check with Power Turned On

4.4.1 Check Items After Turning Power On

■ Check items after turning power On System configuration example

Make checks in the following four major steps.

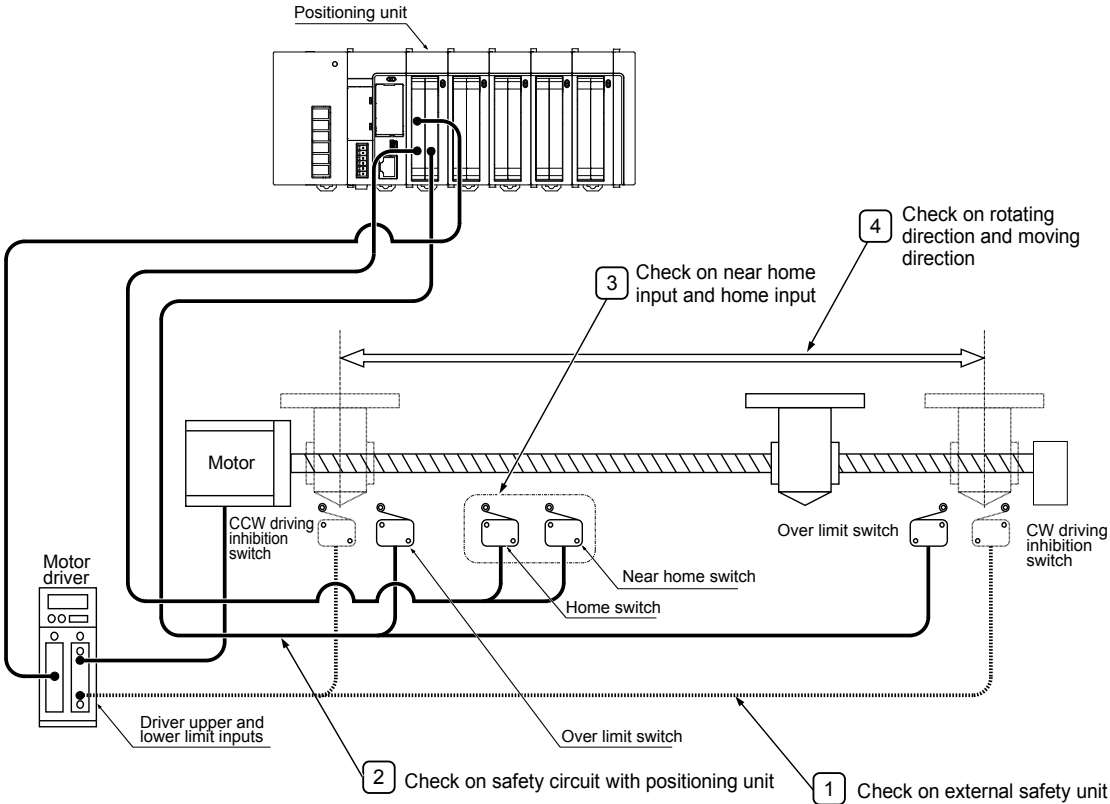

4.4.2 Check on External Safety Circuit

Make a check on the safety circuit recommended by the motor manufacturer, which includes a check on the disconnection of the power supply to the motor driver with CW and CCW drive inhibition switch input from an external circuit.

4.4.3 Check on Safety Circuit with Positioning Unit

Step 1

Forcibly operate the over limit switch for the positioning safety circuit and check that the positioning unit correctly receives limit input.

The state of limit input can be checked with the input contact. The valid logic of limit input can be changed in the parameter-setting menu of the Configurator PM7.

Step 2

Input a program, if necessary, to perform the JOG operation of the positioning unit. Then forcibly operate limit input and check that the motor will come to a stop.

You can use the tool operation of the Configurator PM7 to make a check without using a program.

Step 3

Perform the JOG operation of the positioning unit and check that the over limit switch will operate normally.

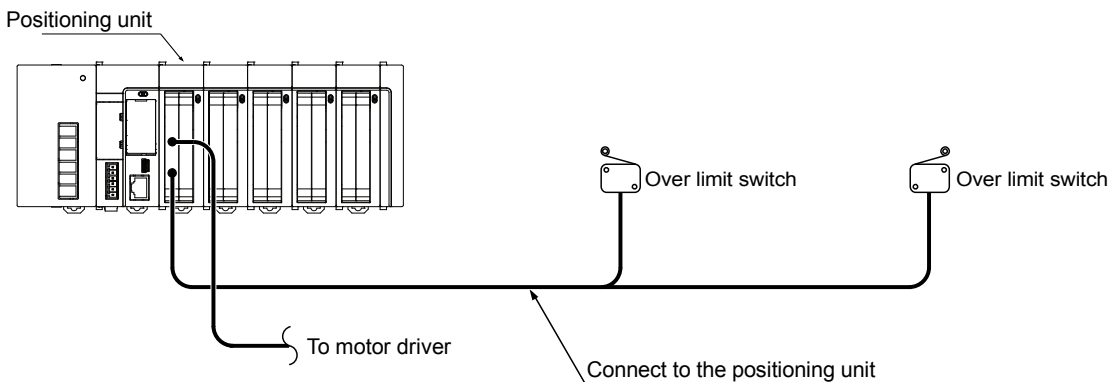

■ Operation at limit input

Condition	Direction	Limit status	Operation
When JOG operation is executed	Forward rotation	Limit input (+):ON	Not executable, Error occurs.
		Limit input (-):ON	Executable
	Reverse rotation	Limit input (+):ON	Executable
		Limit input (-):ON	Not executable, Error occurs.
During JOG operation	Forward rotation	Limit input (+):ON	Deceleration stop, Error occurs.
	Reverse rotation	Limit input (-):ON	Deceleration stop, Error occurs.

4.4.4 Operation Checks on Near Home Switch and Home Switch

Step 1

Forcibly operate home input and near home input and check that the operation indicator of the positioning unit will be lit. Monitor the input contact with the FPWIN GR7 as well and make a similar check.

Step 2

Input a home return program to make an actual home return and check that the positioning unit will perform deceleration with near home input.

Point of confirmation

Set the valid logic of home input and near home input in the parameter-setting menu of the Configurator PM7.

Step 3

Repeat the JOG and home return operation of the positioning unit and check that the home stop position will not shift.

Point of confirmation

A shift may result depending on the position of near home input or home input and the return speed.

Step 4

If the home stopping position is shifted, change the position of near home input or reduce the home return speed.

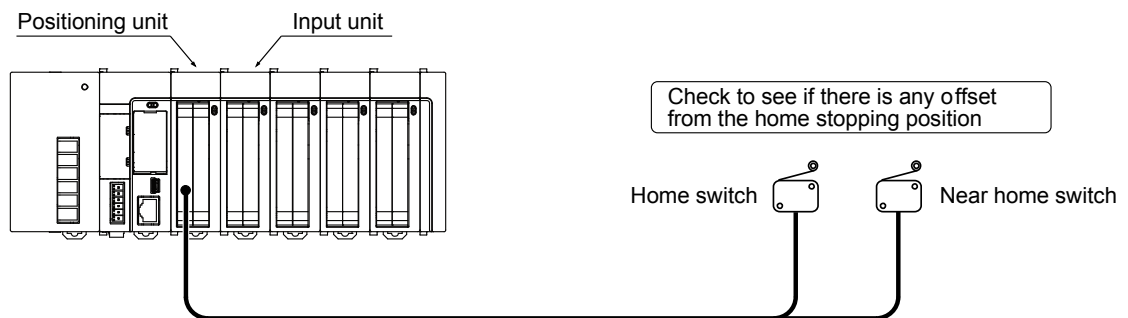

4.4.5 Checking Rotating and Moving Directions and Moving Distance

Step 1

Confirm the rotating direction and moving direction of the motor by the JOG operation of the positioning unit. Use the tool operation function of the Configurator PM7 and perform the JOG operation of the positioning unit.

Point of confirmation

The rotating direction is determined according to the installation of the ball screw or the CW/CCW direction setting parameter.

Step 2

Perform positioning control and check that the moving distance is correct as designed. Use the tool operation function of the Configurator PM7 and perform the JOG or positioning operation of the positioning unit.

Point of confirmation

The moving distance is determined according to the pitch of the ball screw, deceleration gear ratio, or setting movement amount of the positioning data.

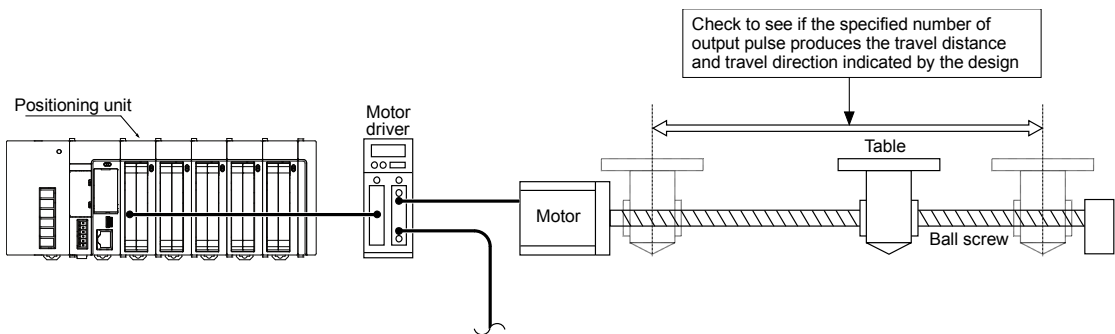

5

Unit Allocation and Parameter Settings

5.1 Unit Allocation

5.1.1 I/O Map Registration

Register the unit with the I/O map before making parameter settings.



◆ PROCEDURE

1. Select "Options" > "FP7 Configuration" > "I/O map" in the menu bar.
The "I/O map" dialog box will be displayed.
2. Double click the desired slot.
The unit selection dialog box will be displayed.
3. Select "Positioning" from the unit type, select the name of the unit to be used, and press the [OK] button.

Unit selection [Slot No. 1]

Select unit to use: _____ [OK]

Unit type: Positioning

Unit name: Positioning line driver type, 4-axis, pulse string [Cancel]

Input time constant: Positioning transistor type, 2-axis, pulse string
Positioning transistor type, 4-axis, pulse string
Positioning line driver type, 2-axis, pulse string
Positioning line driver type, 4-axis, pulse string

Installation location setting: _____

Starting word No. 10 (0 - 511)

Number of input words: 12 (0 - 128)

Number of output words: 12 (0 - 128)

Option _____

Exclude this unit from the target for verification.

Exclude this unit from the target for I/O refresh.

The unit selected in the I/O map is registered.

Slot No.	Product No.	Unit used	Head	Input	Outp...	Veri...	Refresh	Time ...	Consum...
<input type="checkbox"/> 0	AFP7CPS41E	FP7 CPU unit	0	10	10	Valid	Valid		200mA
<input checked="" type="checkbox"/> 1	AFP7PP04L	Positioning line driver	10	12	12	Valid	Valid		65mA
<input type="checkbox"/> 2									
<input type="checkbox"/> 3									

5.1.2 Check on I/O Allocation Information

- Each operation start signal, stop signal, home input signal, and positioning completion signal of the positioning unit is allocated to I/O signals.
- I/O numbers actually used vary with the number of the slot where the unit is installed and the first word number.

■ I/O signal allocation (input)

Signal name	I/O number				
	1st axis	2nd axis	3rd axis	4th axis	Virtual axis
Ready positioning	X0				
Cam table reading completion annunciation	X2				
Cam table rewriting completion annunciation	X3				
Tool operation	X4				
Axis group setting done	X5				
Recalculation done	X7				
Servo lock	X10	X11	X12	X13	X17
BUSY	X18	X19	X1A	X1B	X1F
Operation done	X20	X21	X22	X23	X27
Home return done	X28	X29	X2A	X2B	X2F
Home input	X30	X31	X32	X33	-
Near home input	X38	X39	X3A	X3B	-
Auxiliary contact	X48	X49	X4A	X4B	X4F
Limit +	X50	X52	X54	X56	-
Limit -	X51	X53	X55	X57	-
Error annunciation	X60	X61	X62	X63	X67
Warning annunciation	X68	X69	X6A	X6B	X6F
Synchronous setting done	X80	X81	X82	X83	-
Synchronous control cancel active annunciation	X88	X89	X8A	X8B	-
Slave axis gear ratio change annunciation	X90	X91	X92	X93	-
Slave axis clutch change annunciation	X98	X99	X9A	X9B	-
Positioning speed change request reception annunciation	X110	X111	X112	X113	X117
Positioning movement amount change request reception annunciation	X118	X119	X11A	X11B	X11F

(Note 1): The I/O numbers in the above table show relative addresses based on the base word number. I/O numbers actually used vary with the number of the slot where the unit is installed and the first word number.
Example) The home input of 1st axis is X130 for slot number 1 if the first word is number 10.

Unit Allocation and Parameter Settings

■ I/O signal allocation (output)

Signal name	I/O number				
	1st axis	2nd axis	3rd axis	4th axis	Virtual axis
System stop	Y0				
Cam table reading request	Y2				
Cam table rewriting request	Y3				
Axis group setting change request	Y5				
Request recalculation	Y7				
Servo ON (The operation is the edge type.)	Y8	Y9	YA	YB	-
Positioning start (The operation is the edge type.)	Y10	Y11	Y12	Y13	Y17
Home return start (The operation is the edge type.)	Y18	Y19	Y1A	Y1B	Y1F
JOG forward rotation (The operation is the level type.)	Y20	Y22	Y24	Y26	Y2E
JOG reverse rotation (The operation is the level type.)	Y21	Y23	Y25	Y27	Y2F
Emergency stop (The operation is the level type.)	Y30	Y31	Y32	Y33	Y37
Deceleration stop (The operation is the level type.)	Y38	Y39	Y3A	Y3B	Y3F
Pulser operation permit (The operation is the level type.)	Y40	Y41	Y42	Y43	Y47
J-point speed change (The operation is the edge type.)	Y48	Y49	Y4A	Y4B	Y4F
Servo OFF request (The operation is the edge type.)	Y50	Y51	Y52	Y53	-
J-point positioning start	Y58	Y59	Y5A	Y5B	Y5F
Request error clear	Y60	Y61	Y62	Y63	Y67
Request warning clear	Y68	Y69	Y6A	Y6B	Y6F
Synchronous setting request	Y80	Y81	Y82	Y83	-
Synchronous cancel request	Y88	Y89	Y8A	Y8B	-
Slave axis gear ratio change request (The operation is the edge type.)	Y90	Y91	Y92	Y93	-
Slave axis clutch ON request	Y98	Y99	Y9A	Y9B	-
Slave axis clutch OFF request	Y100	Y101	Y102	Y103	-
Positioning speed change request	Y110	Y111	Y112	Y113	Y117
Positioning movement amount change request	Y118	Y119	Y11A	Y11B	Y11F

(Note 1): The I/O numbers in the above table show relative addresses based on the base word number. I/O numbers actually used vary with the number of the slot where the unit is installed and the first word number.

Example) The home input of 1st axis is Y110 for slot number 1 if the first word is number 10.

5.2 Axis Allocation for Use

5.2.1 Settings in Configurator PM7

Use the Configurator PM7 to allocate axes for the use of the positioning unit along with the purposes of the axes. The following procedure is explained on the condition that the positioning unit has been already allocated in the I/O map.



◆ PROCEDURE

1. Select "Options" > "Positioning Table Settings" in the menu bar. The "Select Positioning Unit" dialog box is displayed.

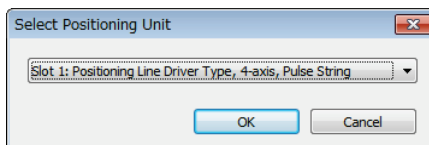

2. Select the slot number and unit of the positioning unit on which the setting is made.

The configuration menu Configurator PM7 for the positioning unit will start.

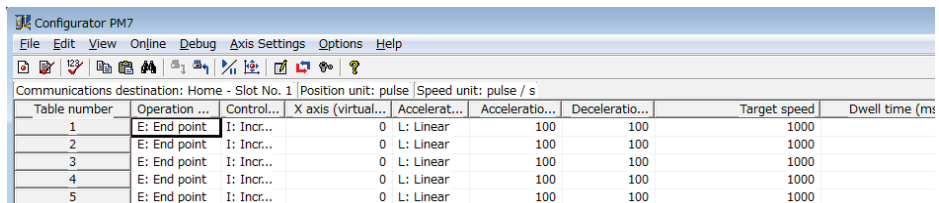

3. Select "Axis setting" → "Change axis" from the menu bar.

The Axis settings dialog box will be displayed.

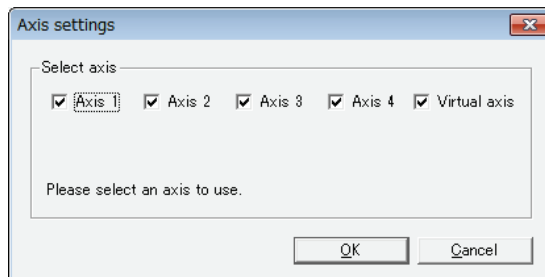

4. Select the axes to be used, and press the [OK] button.

The dialog box for the interpolation operation group setting will be displayed.

5. Drag the icon of each axis to be allocated for interpolation to the interpolation group field.

The following picture shows the allocation of 1st axis and 2nd axis to the interpolation group.

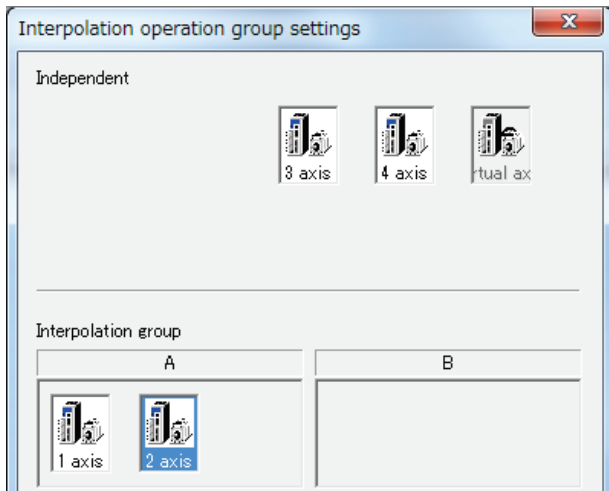

6. Press the [OK] button.

A confirmation message will be displayed.

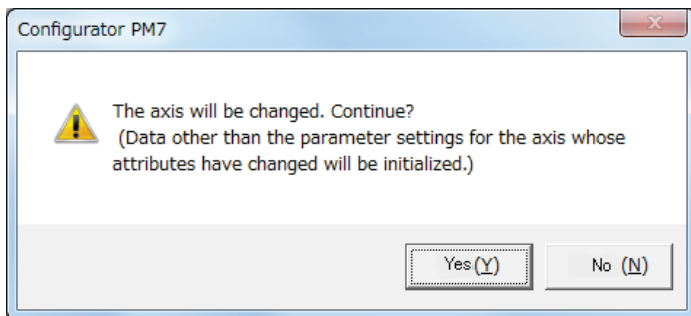

7. Check the contents of the change and press the [Yes] button.

A data table tab each is created for the groups set.

13	E: End point	I: Increment	0	L: Linear	100
14	E: End point	I: Increment	0	L: Linear	100

Virtual axis [A] 1,2Axis 3Axis 4Axis



◆ KEY POINTS

- Setting items, such as the movement and interpolation of X-, Y-, and Z-axis, will be added to the data table, and group name [A] or [B] will be displayed on the tab when the interpolation group is set.
- The virtual axis and slave axes under synchronous control cannot be set to the interpolation groups.
- Closing the window with the X mark during editing cancels and stops the operation.

5.3 Parameter Settings

5.3.1 Parameter Settings in Configurator PM7

Use the Configurator PM7 to allocate the most fundamental parameters for positioning control, such as the motor rotation direction, pulse output method (CW/CCW and Pulse/Sign), home input, limit input logic, and positioning control. The following procedure is explained on the condition that the Configurator PM7 has already started.



◆ PROCEDURE

1. Select “Set axis” → “Set parameters” from the menu bar.

The “Parameter settings” dialog box will be displayed.

	Virtual axis	1 axis [A]	2 axis [A]	3 axis	4 axis
Unit setting	Ppulse	Ppulse	Ppulse	Ppulse	Ppulse
Number of pulses per revolution	1	1	1	1	1
Movement per revolution	1	1	1	1	1
Pulse output method	-----	0:Pulse/Sign	0:Pulse/Sign	0:Pulse/Sign	0:Pulse/Sign
Pulse output rotation direction	-----	0: Clockwise positive	0: Clockwise positive	0: Clockwise positive	0: Clockwise positive
Limit switch	-----	N: Disabled	N: Disabled	N: Disabled	N: Disabled
Limit + switch logic	-----	1:Normal Close	1:Normal Close	0:Normal Open	0:Normal Open
Limit - switch logic	-----	1:Normal Close	1:Normal Close	0:Normal Open	0:Normal Open
Home position logic	-----	0:Normal Open	0:Normal Open	0:Normal Open	0:Normal Open
Home position proximity logic	-----	0:Normal Open	0:Normal Open	0:Normal Open	0:Normal Open
Input Time Constrat - Pulse Input	-----	0: No input time constant	0: No input time constant	0: No input time constant	0: No input time constant

2. Make necessary parameter settings according to the application and press the [OK] button.
3. Select “File” → “Save Config” from the menu bar.



◆ KEY POINTS

- Closing the window with the X mark during editing cancels and stops the operation.

5.3.2 Parameter Setting Items

■ **Setting items**

Parameter name	Description	Related page
Unit setting	The unit to be used for setting each axis.	4.4 Check with Power Turned On
Number of pulses per rotation	Number of pulses per motor rotation (note 1)	
Movement amount per rotation	Movement amount per motor rotation (note 1)	
Pulse output method	Pulse output method: Pulse/Sign or CW/CCW	
Rotating direction of pulse output	CW direction +: + direction is CW. CCW direction +: + direction is CCW.	
Limit switch	Enable/disable the limit switch.	
Limit+ switch logic	Limit switch logic in the positive direction	
Limit- switch logic	Limit switch logic in the negative direction	
Home logic	Home switch logic	10.1 Pattern of Home Return
Near home logic	Near home switch logic	
Input time constnat - Pulse input	Set the time constant of each pulse input signal. (Note 2)	—
Input time constant - Home input	Set the time constant of home input signal. (Note 2)	—
Pulse input application	Pulse input application	13.6 Pulse Input
Rotating direction of pulse input	Rotating direction of pulse input (Forward/Reverse)	
Pulse input mode	Mode of pulse input	
Pulse input multiplication	Multiplication of pulse input	
Software limit (positioning control)	Enables/disables the software limit for positioning control.	13.2 Software Limit
Software limit (Home return)	Enables/disables the software limit for home return control.	
Software limit (JOG operation)	Enables/disables the software limit for JOG operation.	
Upper limit of software limit	The upper limit value of the software limit.	
Lower limit of software limit	The lower limit value of the software limit.	
Auxiliary output mode	Operating mode of the auxiliary output contact and auxiliary output code.	13.3 Auxiliary Output Code and Auxiliary Output Contact
Auxiliary output ON time (ms)	The period in which the auxiliary output contact is ON.	
Auxiliary output Delay rate (%)	Rate to perform output when using the delay mode for auxiliary output..	
Movement amount check	Post-check operation with the movement amount check function used	13.6 Pulse Input
Movement amount check value (Pulse)	Check threshold of the movement amount check function	
Numerator of movement amount check correction	The function of movement amount checking is executed based on the pulse input value multiplied by the following ratio. (Numerator of movement amount check correction)/(Denominator of movement amount check correction)	
Denominator of movement amount check correction		
Movement amount check interval (ms)	Time interval to execute the movement amount check function.	

(Note 1): Set only if the set unit is μm , inch, or degree. It should be cancelled down with the movement amount per rotation.

(Note 2): Available for the unit version Ver.1.3 or later.



◆ KEY POINTS

- In the positioning unit, **CW** refers to the rotating direction with a count increase and **CCW** refers to the direction with a count decrease. Therefore, limit input in the **CW** direction is $\text{limit} + \text{input}$ and that in the **CCW** direction is $\text{limit} -$.

Unit Allocation and Parameter Settings

Parameter name	Description	Related page
Startup speed	Startup speed (initial speed) of all types of operation.	13.7 Startup speed
Home return – Return setting code	The pattern of the home return.	10.1 Pattern of Home Return
Home return – Return direction	The operating direction of the home return.	
Home return – Return acceleration time (ms)	The acceleration time of the home return.	
Home return – Return deceleration time (ms)	The deceleration time of the home return.	
Home return – Return target speed	The target speed of the home return.	
Home return – Return creep speed	The speed to search the home position after the proximity input.	
Home return - Home coordinates	Unit system conversion current value after the completion of the home return.	
Home return - Deviation counter clear time (ms)	Output time of deviation counter clear signal	
JOG operation - Acceleration/Deceleration pattern settings	The acceleration/deceleration type of JOG operation.	9.1 Setting and Operation of JOG Operation
JOG operation – Jog acceleration time (ms)	The acceleration time of JOG operation.	
JOG operation – Jog deceleration time (ms)	The deceleration time of JOG operation.	
JOG operation – Target speed	The target rate of JOG operation.	
Emergency stop deceleration time (ms)	The deceleration time when the emergency stop is requested by the input contact.	12.1 Types and Settings of Stop Function
Limit stop deceleration time (ms)	The deceleration time of deceleration operation when the limit is input.	
Error stop deceleration time (ms)	The deceleration time of deceleration operation when an error occurs	
J point – Operation setting code	The acceleration/deceleration pattern of the J point (speed point)	7.1 Basic Operation
J point – Acceleration time (ms)	The acceleration pattern of the J point (speed point)	
J point – Deceleration time (ms)	The deceleration pattern of the J point (speed point)	
J point – Target speed	The target speed of the J point (speed point)	
Pulser operation setting code	The pulser input (1 to 4) in the pulser operation.	11.1 Setting and Operation of Pulser Operation
Pulser input method	Input type of pulse operation	
Pulser operation ratio numerator	The number of movement pulses is calculated from the number of input pulses of the pulser multiplied by the ratio below. (Numerator of ratio of pulser operation)/(Denominator of ratio of pulser operation)	13.6 Pulse Input
Pulser operation ratio denominator		
Pulser operation max. speed	The maximum speed of pulse operation	

5.4 Synchronous Parameter/Cam Pattern Settings

5.4.1 Synchronous Parameter Settings

Use the Configurator PM7 to allocate parameters necessary for synchronous control. The following procedure is explained on the condition that the Configurator PM7 has already started.



◆ PROCEDURE

1. Select “Axis Settings” → “Synchronization parameter settings” from the menu bar.

The synchronous parameter dialog box will be displayed.

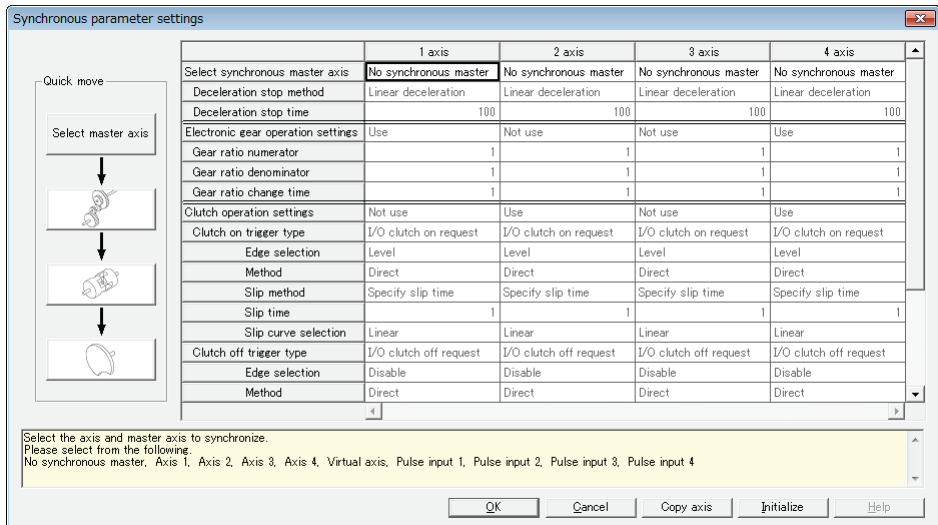

2. Make necessary parameter settings according to the application and press the [OK] button.



◆ KEY POINTS

- Closing the window with the X mark during editing cancels and stops the operation.



◆ REFERENCE

Refer to Chapter 8: Automatic Operation (Synchronous Control) for parameter settings related to synchronous control.

5.4.2 Cam Pattern Settings

Make electronic cam settings in the case of using an electronic cam. Use the Configurator PM7 to allocate necessary parameters. The following procedure is explained on the condition that the Configurator PM7 has already started.



◆ PROCEDURE

1. Select “Axis Settings” → “Cam pattern settings” from the menu bar.

The cam pattern setting dialog box will be displayed.

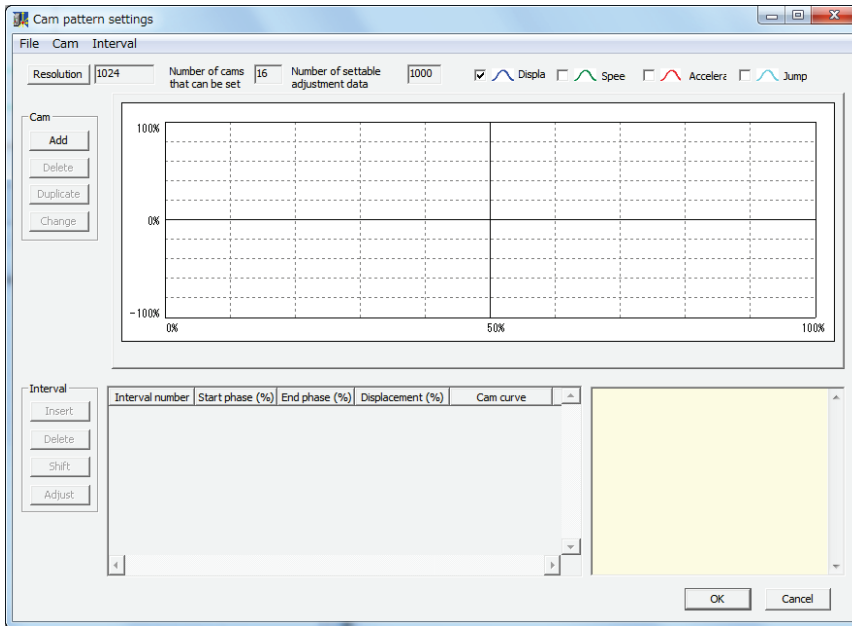

2. Make necessary parameter settings according to the application and press the [OK] button.
3. Select “File” → “Save Configuration” from the menu bar.



◆ KEY POINTS

- Parameter information saved can be read on the Configurator PM7.
- In the case of synchronous control, basic parameters related to I/O operate according to 5.3 Parameter Settings.

5.5 Creating Positioning Data Table

5.5.1 Construction of Positioning Data Table

Use the Configurator PM7 to allocate the positioning data table. The following procedure is explained on the condition that the Configurator PM7 has already started.

■ Initial display screen of Configurator PM7

- Sheets are divided for each axis, and 600 tables ranging No. 1 to No. 600 can be set.

The screenshot shows the Configurator PM7 software interface. At the top, there is a menu bar with options: File, Edit, View, Online, Debug, Axis Settings, Options, and Help. Below the menu bar is a toolbar with various icons. The main window displays the following information: Communications destination: Home - Slot No. 1, Position unit: pulse, Speed unit: pulse / s. Below this is a table with the following columns: Table number, Operation ..., Control..., X axis (virtual..., Accelerat..., Acceleratio..., Deceleratio..., Target speed, and Dwell time (ms). The table contains five rows of data:

Table number	Operation ...	Control...	X axis (virtual...	Accelerat...	Acceleratio...	Deceleratio...	Target speed	Dwell time (ms)
1	E: End point	I: Incr...	0	L: Linear	100	100	1000	
2	E: End point	I: Incr...	0	L: Linear	100	100	1000	
3	E: End point	I: Incr...	0	L: Linear	100	100	1000	
4	E: End point	I: Incr...	0	L: Linear	100	100	1000	
5	E: End point	I: Incr...	0	L: Linear	100	100	1000	

■ Setting items

Parameter name	Description
Operation pattern	Select one from the following operation patterns. E point: Executes the trapezoidal control of only one table. C point: Executes the trapezoidal control continuously. Specify an end point (E point) at the end of the continuance point (C-point) control. P point: Executes the continuous speed change control. Specify an end point (E point) at the end of the pass point (P-point) control. J point: Executes speed control. Specify an end point (E point) at the end of the speed control (J point).
Control method	Select either increment or absolute coordinate.
X-axis movement amount	Input the movement amount of X-axis. The movement amount depends on the unit system specified in the parameter settings.
Acceleration/deceleration pattern	Select the acceleration/deceleration pattern.
Acceleration time (ms)	Set the acceleration time. Setting unit: ms
Deceleration time (ms)	Set the deceleration time. Setting unit: ms
Target speed	Set the target speed. Set in ms. Setting unit: pps, $\mu\text{m/s}$, inch/s, rev/s
Dwell Time (ms)	Set the time from when the positioning instruction in the end point control completes until the positioning done flag turns ON. For the continuance point control, it is the wait time between each table. For the pass point control, the dwell time is ignored.
Auxiliary output	Set the auxiliary output code. When the auxiliary output is set to enable in the parameter settings, the auxiliary output code specified here is output.
Comment	Arbitrary comments can be input for each table.

(Note 1): The details for the settings in each parameter are indicated in the guidance bar.

(Note 2): In the case of selecting interpolation control, interpolation, Y-axis movement amount, X-axis auxiliary point, Y-axis auxiliary point, and interpolation speed as items are displayed as well.

5.5.2 Table No. Positioning Start

- Execute the POSSET command in the user program to specify table numbers on the Configurator PM7.
- The positioning unit will start control under the conditions set in the table by executing the POSSET reference and turning the corresponding positioning start contact ON after specifying the desired slot number, axis number, and table number.

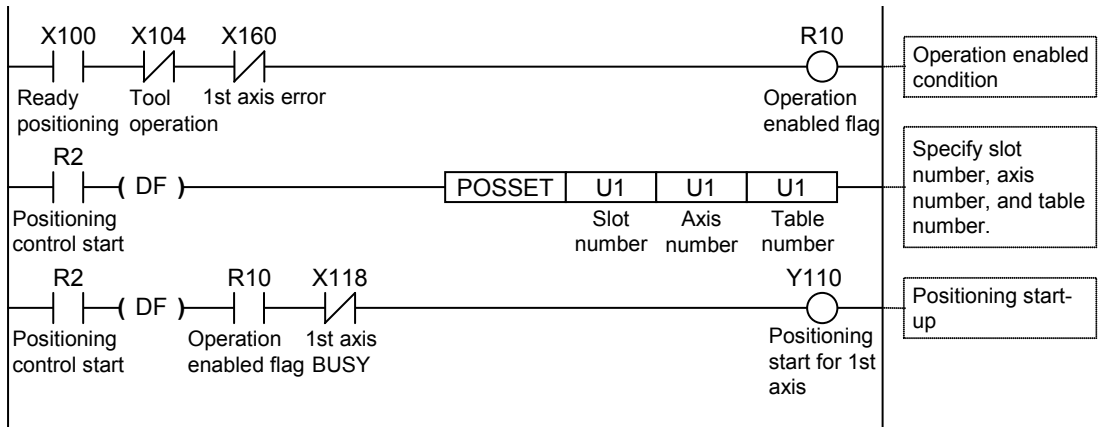

5.5.3 Operation Patterns and Tables

- Use a number of tables if the positioning patterns consist of pass point control, continuance point control, and JOG positioning control.
- In these types of control, the tables will be created continuously on the Configurator PM7, and select the end point control for the operation pattern for the last table.
- Specify the first data table number for each control in the program.

(Example) Pass point control

Create three positioning data tables, and select “E: End point” for the last table. Furthermore, start the first table number for each control in the user program.

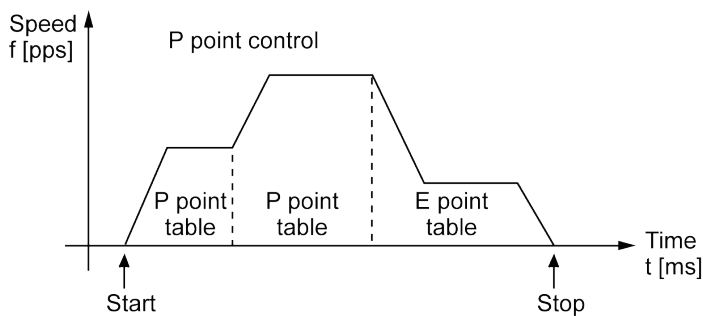

Table number	Operation pattern	Control method	X axis (virtual) movement	Acceleration/deceleration method
1	P: Pass point	I: Increment	50000	L: Linear
2	P: Pass point	I: Increment	100000	L: Linear
3	E: End point	I: Increment	30000	L: Linear



◆ REFERENCE

For detailed information on each control, refer to Chapter “7. Automatic Operation (Positioning Control)”

5.6 Saving Parameters

5.6.1 Saving and Loading of Configuration

Information on the basic parameters and positioning data tables that have been set for the Configurator PM7 are saved as configuration information along with information on I/O map allocations on a unit-by-unit basis. Save and load the configuration information as necessary.

- Specified basic parameters and positioning parameters can be saved or loaded on the Configurator PM7.
- Information on positioning parameters and positioning tables saved by using the save function can be reused between projects.



◆ PROCEDURE

1. Select "File" > "Save Setting" from the menu bar.

The saving destination and file names are displayed.

2. Enter the saving destination and file name, and press [Save] button.

Information on the parameters and positioning data tables is saved in a file with a ".pm7" extension.



◆ KEY POINTS

- When "Save Setting" is executed, information on the positioning data tables will be saved along with information set in the parameter setting menu.
- Closing the window with the X mark during editing cancels and stops the operation.
- The menu names of Configurator PM7 have been changed from FPWIN GR7 Ver.2.7.

Menu names of Configurator PM7		Function
FPWINGR7 Ver.2.6 or older	FPWINGR7 Ver.2.7 or later	
New (N)	Initialize Setting (N)	Positioning parameters and positioning data table are newly created on Configurator PM7.
Load Configuration (J)	(None)	
Save Configuration (K)	Apply Setting (K)	Positioning parameters and positioning table data being edited on Configurator PM7 are saved as data being edited.
Import (O)	Read Setting (O)	Saved files (Extension: .pm7) are read.
Export (S)	Save Setting (S)	Data being edited offline on Configurator PM7 is saved as a file (Extension: .pm7).

6

Transfer to Unit and Commissioning

6.1 Check on Setting Contents

6.1.1 Check on Parameter Data

- The following procedure is explained on the condition that the Configurator PM7 has already started.



◆ PROCEDURE

1. Select “Debug” → “Check parameters and data values” from the menu bar.

A message box will be displayed to show the check result. If there is an error in the settings for the positioning data tables, an error message will appear and the cursor will move to the corresponding error position.

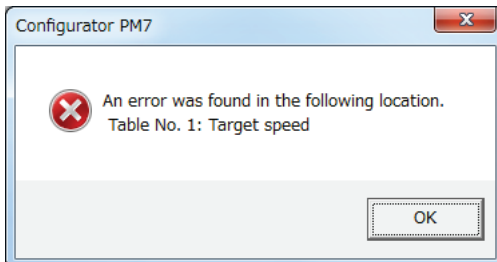

6.1.2 Comparison of Parameter Information

- It is possible to compare information on parameters being edited with information saved in the Configurator PM7. The following procedure is explained on the condition that the Configurator PM7 has already started.



◆ PROCEDURE

1. Select “Debug” → “Compare” → “File” or “PLC” from the menu bar.

When “File” is selected, a dialog box for comparison file selection will be displayed.

When “PLC” is selected, information edited in the Configurator PM7 will be compared with configuration information saved in the unit memory (UM) of PLC, and the results of comparison will be displayed.

2. Select the target file from the dialog box for the selection of the comparison file, and press the [OK] button.

The comparison results will be displayed.

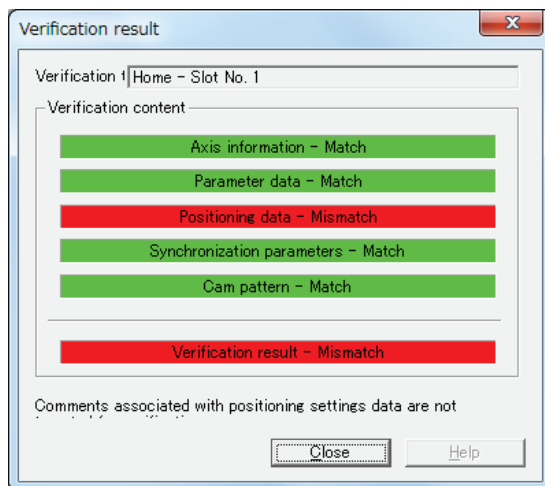

◆ KEY POINTS

- Even if "Save Setting" is executed on Configurator PM7, data will not be saved in the unit memory (UM) of the PLC. When "PLC" is selected as the verification target, verification results may not coincide.
- The menu names of Configurator PM7 have been changed from FPWIN GR7 Ver.2.7.

Menu names of Configurator PM7		Function
FPWINGR7 Ver.2.6 or older	FPWINGR7 Ver.2.7 or later	
File (F)	File (F)	Data being edited on Configurator PM7 is collated with saved files (Extension: .PM7).
Unit (U)	PLC (U)	Data is being edited on Configurator PM7 is collated with data stored in the unit memory (UM) of the PLC.
Config (C)	(None)	

6.2 Transfer of Parameters

6.2.1 Writing Parameters to CPU Unit

- Information on parameters that have been set is transferred as a part of project information to the CPU unit along with other configuration information.
- The following procedure is explained on the condition that the Configurator PM7 has already started.



◆ PROCEDURE

1. **1. Select “File” → “Exit” from the menu bar of the Configurator PM7.**

A confirmation message is displayed when any parameters or positioning tables have been changed.

2. **When the message "Setting data will be applied. Are you sure you want to proceed?" appears, press [Yes (Y)].**

A confirmation message is displayed.

3. **Press the [OK] button.**

4. **Select “Online” → “Download to PLC” from the FPWIN GR7 menu bar.**

Parameters for the positioning unit will be downloaded to the CPU unit along with the program and other configuration information.

5. **Set the FP7 CPU unit to RUN mode.**

The configuration information will be transferred to the positioning unit so that the positioning unit will be read for commissioning with I/O signals or the Configurator PM7.

6. **Select “Option” → “Positioning Table Settings” from the menu bar.**

The Configurator PM7 will be activated.

Select [Online] → [Data monitor] → [Status display] → [Tool operation] so that each menu items of the positioning unit will be available.



◆ KEY POINTS

- **The starting method of Configurator PM7 has been changed from FPWIN GR7 Ver. 2.8. Select "Positioning Table Settings" from the "Options" menu.**
- **From FPWIN GR7 Ver.2.8, "Write PLC" and "Read PLC" can be executed from the "File" menu of Configurator PM7.**

6.3 Monitoring on Configurator PM7

6.3.1 Status Monitor

- It is possible to monitor the connection state of each axis and input state of the external terminal.
- The following procedure is explained on the condition that the Configurator PM7 has already started.



◆ PROCEDURE

1. Select “Online” → “Status monitor” from the menu bar.

The status monitor dialog box will be displayed.

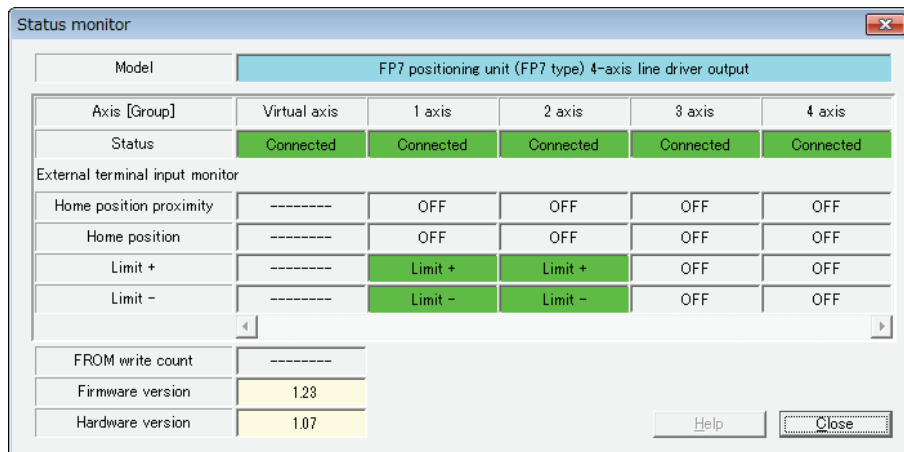

6.3.2 Data Monitor

- It is possible to monitor the connection state of each axis and input state of the external terminal.



◆ PROCEDURE

1. Select “Online” → “Data Monitor” from the menu bar.

The data monitor dialog box will be displayed.

Transfer to Unit and Commissioning

Axis [Group]	Virtual axis	1 axis	2 axis	3 axis	4 axis
Synchronous master axis	Master	Virtual axis	Virtual axis	Master	3 axis
Synchronized output	-----	Gear	Clutch + Cam	-----	Gear + Clutch + Cam
Synchronous state	Synchronous	Synchronous	Synchronous	Synchronous	Synchronous
Table number executing	0	0	0	0	0
Auxiliary output code	0	0	0	0	0
Current value	0	0	0	0	0
Unit conversion current value	0 pulse	0 pulse	0 pulse	0 pulse	0 pulse
Pulse input value	-----	0	0	0	0
Deviation	-----	0	0	0	0
Axis state	Stopped	Stopped	Stopped	Stopped	Stopped
Error code	-----	-----	-----	-----	-----
	Clear errors	Clear errors	Clear errors	Clear errors	Clear errors
Warning code	-----	-----	-----	-----	-----
	Clear warning	Clear warning	Clear warning	Clear warning	Clear warning

■ Monitor items

Items	Description	Related page
Synchronous master axis	When an axis has been set as master axis, "Master" is displayed. When an axis has been set as slave axis, the master axis which this axis follows is displayed. Example) When the second axis has been set as a slave axis for the master of first axis, "1 axis" is displayed in the column of 2 axis. For axes that are not used for the synchronous control, "-----" is displayed.	8.1 Synchronous Control
Synchronous output	The functions of synchronous operation that have been set for slave axes are displayed. Gear, Clutch, Cam Gear+Clutch, Gear+Cam, Clutch+Cam Gear+Clutch+Cam For axes that are not used for the master axes and synchronous control, "-----" is displayed.	
Synchronous state	The states (synchronous/asynchronous) that have been set for each axis are displayed.	
Active table number	The table number that the positioning data is being executed or has been executed.	5.5 Creating Positioning Data Table
Auxiliary output code	When the auxiliary output function is enabled, output code is output within the range of 0 to 65536.	13.3 Auxiliary Output Code and Auxiliary Output Contact
Current value	The current value of the positioning unit is displayed. It will return to "0" on the completion of home return.	13.4 Current Value Update
Unit conversion current value	The unit-converted current value of the positioning unit is displayed. It will return to "0" on the completion of home return. When the coordinate origin has been set, it will be preset to the coordinate origin on the completion of home return.	13.5 Coordinate Origin

Items	Description	Related page
Pulse input value	When the pulse input function is enabled, input pulse values are displayed. In the case of virtual axes, "-----" is displayed.	13.6 Pulse Input
Deviation	When the movement amount automatic check function is enabled, deviations are displayed. In the case of virtual axes, "-----" is displayed.	
Axis state	"Running" or "Stopped" is displayed. When an error has occurred, "Error occurred" is displayed.	
Error code	When an error has occurred, the latest error code is displayed. Pressing the "Clear errors" button clears errors.	15.1 About Errors and Warnings
Warning code	When a warning has occurred, the latest warning code is displayed. Pressing the "Clear warnings" button clears warnings.	



NOTES

- If a recoverable error occurs in the positioning unit, click the [Error clear] button to clear the error.
- If a warning occurs in the positioning unit, click [Warning clear] to clear the warning.

6.4 Tool Operation

6.4.1 Tool Operation Function

- You can perform commissioning with the Configurator PM7 before actually starting the user program.
- Be sure to save the settings and download the project to the CPU unit before starting the tool operation of the positioning unit.
- The following procedure is explained on the condition that the Configurator PM7 has already started.



◆ PROCEDURE

1. Select “Online” → “Tool Operation” from the menu bar.

The tool operation dialog box will be displayed.

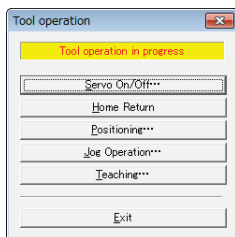

■ Types of tool operation

Items	Description
Servo ON/OFF	Specifies servo ON/OFF for each axis.
Home return	A home return is performed to the home of the machine coordinates according to the specified parameter.
Positioning	Moves from the start table number according to the set contents in the positioning table.
JOG operation	The specified axis can be moved to the specified direction at the specified speed while the operation reference is ON.
Teaching	Controls the axis manually like JOG operation, and reflects the resulting positioning address on the Data Editing screen.



◆ KEY POINTS

- The positioning unit cannot go into tool operation while the positioning unit is in user program operation.
- Operation requests with I/O signals will be disabled while the positioning unit is in tool operation.
- If any communication error occurs while the positioning unit is in tool operation, the positioning unit will detect the error and stop automatically. Also, if the previous tool operation does not finish properly due to a communication error, etc., the tool operation mode will be cancelled forcibly when the next tool operation starts. Exit the operation once, and start the tool operation again.

6.4.2 Serve ON/OFF with Tool Operation Function

The following procedure is explained on the condition that the Configurator PM7 has already started.



◆ PROCEDURE

1. Select "Online" > "Tool Operation" from the menu bar.

The "Tool operation" dialog box will be displayed.

2. Select "Servo ON/OFF" in the "Tool operation" dialog box.

The "Servo ON/OFF" dialog box will be displayed.

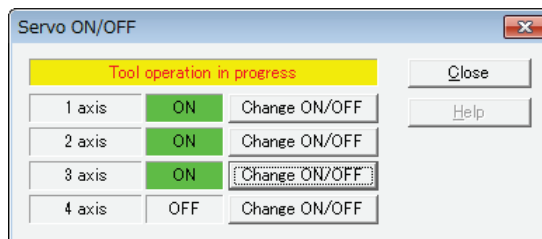

3. Press the "Change ON/OFF" button for an arbitrary axis.

The state is switched between servo lock and servo free.

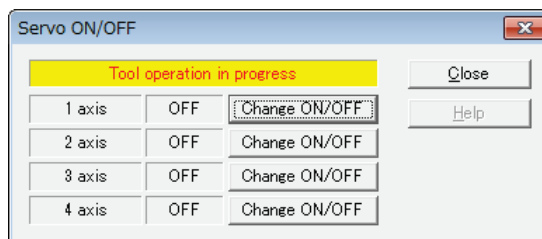

4. Confirm the servo ON/OFF states of arbitrary axes, and press the "Close" button.

This returns to the "Tool operation" dialog box.



◆ KEY POINTS

- If the servo ON/OFF has been controlled using ladder programs, the servo-lock or servo-free state before the start of the tool operation is kept and the operation shifts to the tool operation.
- The servo-lock or servo-free state before the completion will be kept even after finishing the tool operation mode.

6.4.3 JOG Operation with Tool Operation Function

- You can perform commissioning with the Configurator PM7 before actually starting the user program.
- The following procedure is explained on the condition that the Configurator PM7 has already started.



◆ PROCEDURE

1. Select “Online” → “Tool Operation” from the menu bar.
The tool operation dialog box will be displayed.
2. Select “JOG operation” from the tool operation dialog box.
The tool operation-JOB operation dialog box will be displayed.

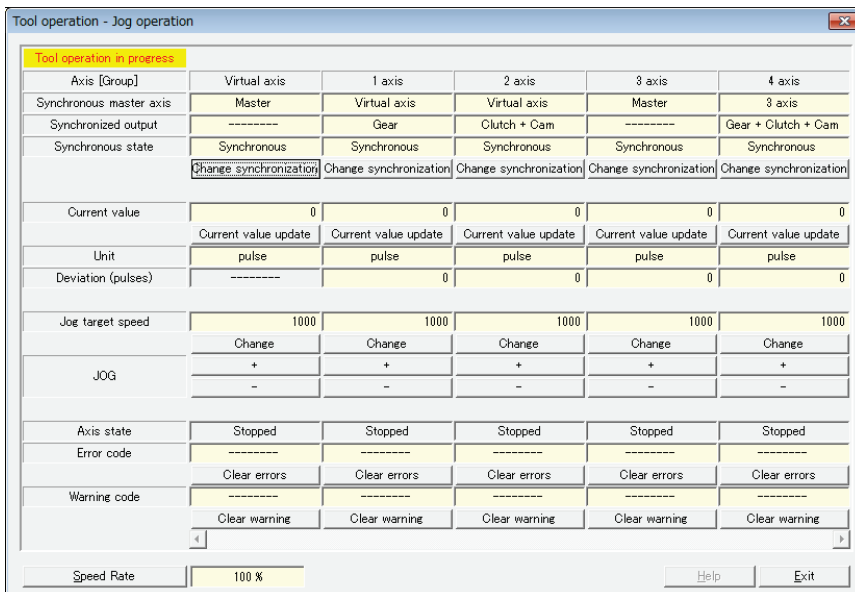

3. Press [+] or [-] button in the JOG field.
The JOG operation of the positioning unit starts.
4. Press [Quit] button to terminate the JOG operation.



◆ KEY POINTS

- If an recoverable error occurs in the positioning unit, click the [Clear errors] button to clear the error.
- If a warning occurs in the positioning unit, click [Clear warning] to clear the warning.
- This dialog box cannot be closed during the operation.

■ Dialog box items

Items	Description	Related page
Synchronous master axis	When an axis has been set as master axis, "Master" is displayed. When an axis has been set as slave axis, the master axis which this axis follows is displayed. Example) When the second axis has been set as a slave axis for the master of first axis, "1 axis" is displayed in the column of 2 axis. For axes that are not used for the synchronous control, "-----" is displayed.	8.1 Synchronous Control
Synchronous output	The functions of synchronous operation that have been set for slave axes are displayed. Gear, Clutch, Cam Gear+Clutch, Gear+Cam, Clutch+Cam Gear+Clutch+Cam For axes that are not used for the master axes and synchronous control, "-----" is displayed.	
Synchronous state	The states (synchronous/asynchronous) that have been set for each axis are displayed. Pressing the "Change synchronization" button switches the state between Synchronous and Asynchronous.	
Current value	Monitors the feedback values after the unit system conversion for each axis. Click [Current value update] to display the dialog for inputting value to change the preset value.	13.4 Current Value Update
Unit	The units of position for each axis specified in the parameter settings are displayed.	
Deviation (pulse)	When the movement amount automatic check function is enabled, deviations are displayed. In the case of virtual axes, "0" is displayed when the function is not used.	13.6 Pulse Input
JOG target speed	Monitors and displays the target speed in the JOG operation. Click [Change] to change the target speed for the JOG operation.	9.1 Setting and Operation of JOG Operation
JOG [+]	Performs the JOG forward rotation while pressing [+].	
JOG [-]	Performs the JOG reverse rotation while pressing [-].	
Axis state	"Running" or "Stopped" is displayed. When an error has occurred, "Error occurred" is displayed.	
Error code	When an error has occurred, the latest error code is displayed. Pressing the "Clear errors" button clears errors.	15.1 About Errors and Warnings
Warning code	When a warning has occurred, the latest warning code is displayed. Pressing the "Clear warnings" button clears warnings.	
Speed rate	The target speed of the JOG operation specified in the parameter settings for each axis is regarded as 100%, and the operation is executed in the specified speed rate. Clicking [Speed Rate] shows the dialog for inputting the value.	

6.4.4 Home Return by Tool Operation Function

- When the power is turned on, the coordinates of the positioning unit do not coincide with those of the machine position. Execute a home return before starting positioning.
- You can perform commissioning with the Configurator PM7 before actually starting the user program.
- The following procedure is explained on the condition that the Configurator PM7 has already started.



◆ PROCEDURE

1. Select “Online” → “Tool Operation” from the menu bar.
The tool operation dialog box will be displayed.
2. Select “Home Return” from the tool operation dialog box.
The tool operation-home return dialog box is displayed.

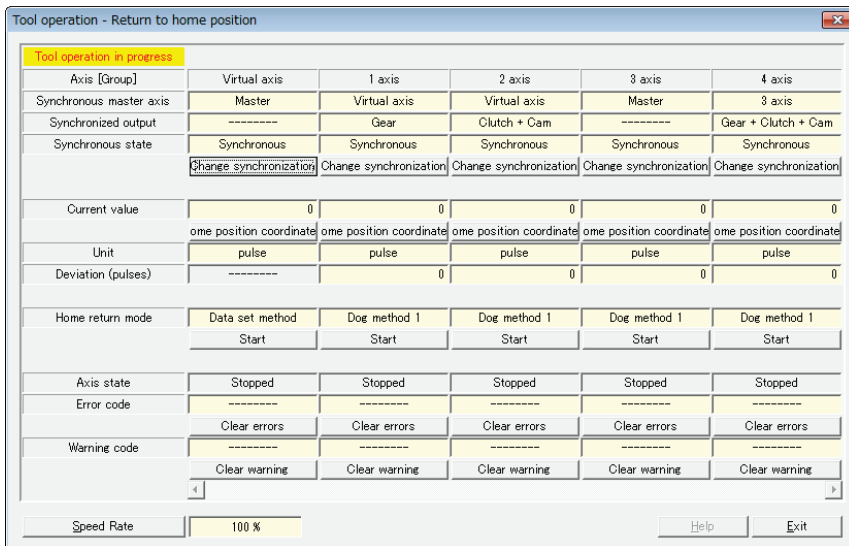

3. Press the [Start] button for the axis to be returned home.
Execute the home return.
4. Press [Quit] button to terminate the home return operation.



◆ KEY POINTS

- If an recoverable error occurs in the positioning unit, click the [Error Clear] button to clear the error.
- If a warning occurs in the positioning unit, click [Warning clear] to clear the warning.
- This dialog box cannot be closed during the operation.

■ Dialog box items

Items	Description	Related page
Synchronous master axis	When an axis has been set as master axis, "Master" is displayed. When an axis has been set as slave axis, the master axis which this axis follows is displayed. Example) When the second axis has been set as a slave axis for the master of first axis, "1 axis" is displayed in the column of 2 axis. For axes that are not used for the synchronous control, "-----" is displayed.	8.1 Synchronous Control
Synchronous output	The functions of synchronous operation that have been set for slave axes are displayed. Gear, Clutch, Cam Gear+Clutch, Gear+Cam, Clutch+Cam Gear+Clutch+Cam For axes that are not used for the master axes and synchronous control, "-----" is displayed.	
Synchronous state	The states (synchronous/asynchronous) that have been set for each axis are displayed. Pressing the "Change synchronization" button switches the state between Synchronous and Asynchronous.	
Current value	Displays the feedback values after the unit system conversion for each axis. Click [Home position coordinate] to display the dialog box for inputting value to change the value after home return.	13.4 Current Value Update
Unit	The units of position for each axis specified in the parameter settings are displayed.	
Deviation (pulse)	When the movement amount automatic check function is enabled, deviations are displayed. In the case of virtual axes, "0" is displayed when the function is not used.	13.6 Pulse Input
Home return mode	Displays the content of the home return setting code registered in the positioning setting data.	10.1 Pattern of Home Return
Start/Stop	Executes the operation to start/stop the home return. - Click [Start] to execute the home return operation. The button name changes to [Stop]. - Click [Stop] to execute the deceleration stop operation. The button name changes to [Start].	
Axis state	"Running" or "Stopped" is displayed. When an error has occurred, "Error occurred" is displayed.	
Error code	When an error has occurred, the latest error code is displayed. Pressing the "Clear errors" button clears errors.	15.1 About Errors and Warnings
Warning code	When a warning has occurred, the latest warning code is displayed. Pressing the "Clear warnings" button clears warnings.	
Speed rate	The target speed of the home return specified in the parameter settings for each axis is regarded as 100%, and the operation is executed in the specified speed rate. Clicking [Speed rate] shows the dialog box for inputting the value.	

6.4.5 Positioning by Tool Operation Function

Specifying a starting table number enables to check if positioning from the starting table operates properly.



◆ PROCEDURE

1. Select “Online” → “Tool Operation” from the menu bar.

The tool operation dialog box will be displayed.

2. Select “Positioning” from the tool operation dialog box.

The tool operation-positioning dialog box will be displayed.

Tool operation - Positioning					
Tool operation in progress.					
Axis [Group]	Virtual axis	1 axis	2 axis	3 axis	4 axis
Synchronous master axis	Master	Virtual axis	Virtual axis	Master	3 axis
Synchronized output	-----	Gear	Clutch + Cam	-----	Gear + Clutch + Cam
Synchronous state	Synchronous	Synchronous	Synchronous	Synchronous	Synchronous
	<input type="button" value="Change synchronization"/>	<input type="button" value="Change synchronization"/>	<input type="button" value="Change synchronization"/>	<input type="button" value="Change synchronization"/>	<input type="button" value="Change synchronization"/>
Current value	0	0	0	0	0
	<input type="button" value="Current value update"/>	<input type="button" value="Current value update"/>	<input type="button" value="Current value update"/>	<input type="button" value="Current value update"/>	<input type="button" value="Current value update"/>
Unit	pulse	pulse	pulse	pulse	pulse
Deviation (pulses)	-----	0	0	0	0
Table number executing	-----	-----	-----	-----	-----
Start table number	1	1	1	1	1
	<input type="button" value="Change"/>	<input type="button" value="Change"/>	<input type="button" value="Change"/>	<input type="button" value="Change"/>	<input type="button" value="Change"/>
	<input type="button" value="Operation"/>	<input type="button" value="Operation"/>	<input type="button" value="Operation"/>	<input type="button" value="Operation"/>	<input type="button" value="Operation"/>
Axis state	Stopped	Stopped	Stopped	Stopped	Stopped
Error code	-----	-----	-----	-----	-----
	<input type="button" value="Clear errors"/>	<input type="button" value="Clear errors"/>	<input type="button" value="Clear errors"/>	<input type="button" value="Clear errors"/>	<input type="button" value="Clear errors"/>
Warning code	-----	-----	-----	-----	-----
	<input type="button" value="Clear warning"/>	<input type="button" value="Clear warning"/>	<input type="button" value="Clear warning"/>	<input type="button" value="Clear warning"/>	<input type="button" value="Clear warning"/>
Speed Rate	100 %				
	<input type="button" value="Help"/>				<input type="button" value="Exit"/>

3. Press the [Change] button under the target start table number field.

The dialog box to set the start table number will be displayed.

4. Input the start table number.

5. Press the [Operate] button.

Positioning will start from the specified start table number.

6. Press [Exit] button to terminate the positioning operation.

- When conditions are changed during the tool operation, the unit memory will be updated temporarily and the operation will be performed, however, the changed conditions will not be reflected in the configuration data written in the CPU unit. Therefore, when the mode is changed to the RUN mode again, the unit will start based on the configuration data downloaded to the CPU unit.



◆ KEY POINTS

- **For the positioning operation, the setting data should be downloaded to the positioning unit in advance. The operations after the starting table number vary depending on the operation patterns.**
- **If an recoverable error occurs in the positioning unit, click the [Error clear] button to clear the error.**
- **If a warning occurs in the positioning unit, click [Warning clear] to clear the warning.**
- **The positioning operation of the interpolation group starts and stops the axis with the smallest number in the group. If the tool operation function is used, positioning will start by pressing the [Run] button for any axis. A warning message, however, will be displayed unless the [Run] button for the axis with the smallest number is pressed.**
- **This dialog cannot be closed while the positioning unit is in home return operation.**

■ Dialog box items

Items	Description	Related page
Synchronous master axis	When an axis has been set as master axis, "Master" is displayed. When an axis has been set as slave axis, the master axis which this axis follows is displayed. Example) When the second axis has been set as a slave axis for the master of first axis, "1 axis" is displayed in the column of 2 axis. For axes that are not used for the synchronous control, "-----" is displayed.	8.1 Synchronous Control
Synchronous output	The functions of synchronous operation that have been set for slave axes are displayed. Gear, Clutch, Cam Gear+Clutch, Gear+Cam, Clutch+Cam Gear+Clutch+Cam For axes that are not used for the master axes and synchronous control, "-----" is displayed.	
Synchronous state	The states (synchronous/asynchronous) that have been set for each axis are displayed. Pressing the "Change synchronization" button switches the state between Synchronous and Asynchronous.	
Current value	Monitors the feedback values after the unit system conversion for each axis. Click [Current value update] to display the dialog for inputting value to change the preset value.	13.4 Current Value Update
Unit	The units of position for each axis specified in the parameter settings are displayed.	
Deviation (pulse)	When the movement amount automatic check function is enabled, deviations are displayed. In the case of virtual axes, "0" is displayed when the function is not used.	13.6 Pulse Input

Items	Description	Related page
Table number executing	Displays the table number during the operation or when it completes.	5.5 Creating Positioning Data Table
Start table number	The starting table number for the positioning control. Click [Change] to change the starting table number.	
Operate/Stop	Execute the operation to start/stop the home return. - Click [Operate] to execute the positioning operation. The button name changes to [Stop]. - Click [Stop] to execute the deceleration stop operation. The button name changes to [Operate].	
Axis state	"Running" or "Stopped" is displayed. When an error has occurred, "Error occurred" is displayed.	
Error code	When an error has occurred, the latest error code is displayed. Pressing the "Clear errors" button clears errors.	15.1 About Errors and Warnings
Warning code	When a warning has occurred, the latest warning code is displayed. Pressing the "Clear warnings" button clears warnings.	
Speed rate	The target speed of the JOG operation specified in the parameter settings for each axis is regarded as 100%, and the operation is executed in the specified speed rate. Clicking [Speed Rate] shows the dialog for inputting the value.	



◆ KEY POINTS

- **For the positioning operation, the setting data should be downloaded to the positioning unit in advance. The operations after the starting table number vary depending on the Operation patterns.**
- **If a recoverable error occurs in the positioning unit, click the [Clear errors] button to clear the error.**
- **If a warning occurs in the positioning unit, click [Clear warning] to clear the warning.**
- **The positioning operation of the interpolation group starts and stops the axis with the smallest number in the group. In the case of the tool operation function, the positioning operation starts by pressing the "Operate" button of any axes, however, a warning message is displayed when the "Operate" button other than that for the smallest axis number is pressed.**
- **This dialog box cannot be closed during the operation.**
- **When conditions are changed during the tool operation, the unit memory will be updated temporarily and the operation will be performed, however, the changed conditions will not be reflected in the configuration data written in the CPU unit. Therefore, when the mode is changed to the RUN mode again, the unit will start based on the configuration data downloaded to the CPU unit.**

6.4.6 Teaching by Tool Operation Function

Activate each axis manually by the tool operation, and register the positioning addresses where the axes come to a stop as the point data.



◆ PROCEDURE

- 1. Select “Online” → “Tool Operation” from the menu bar.

The tool operation dialog box will be displayed.

- 2. Select “Teaching” from the tool operation dialog box.

The tool operation-teaching dialog box will be displayed.

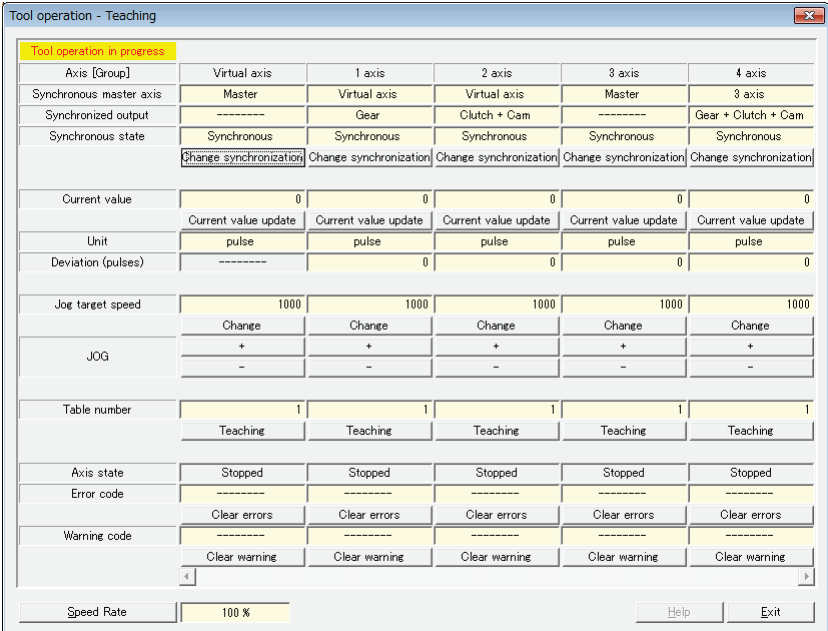

- 3. Perform the JOG operation of the positioning unit to stop the positioning unit at the positioning point.
- 4. Press the [Teaching] button.
- 5. Input the table number where the desired positioning information is registered, and click the [OK] button.

The current value will be registered for the amount of movement of the table number specified. If the axis that the teaching operation is performed is the interpolation axis, the current value is registered for the movement amount of the equivalent coordinate in the interpolation group.

- 6. Press [Exit] button to terminate teaching.

Transfer to Unit and Commissioning

■ Dialog box items

Items	Description	Related page
Synchronous master axis	When an axis has been set as master axis, "Master" is displayed. When an axis has been set as slave axis, the master axis which this axis follows is displayed. Example) When the second axis has been set as a slave axis for the master of first axis, "1 axis" is displayed in the column of 2 axis. For axes that are not used for the synchronous control, "-----" is displayed.	8.1 Synchronous Control
Synchronous output	The functions of synchronous operation that have been set for slave axes are displayed. Gear, Clutch, Cam Gear+Clutch, Gear+Cam, Clutch+Cam Gear+Clutch+Cam For axes that are not used for the master axes and synchronous control, "-----" is displayed.	
Synchronous state	The states (synchronous/asynchronous) that have been set for each axis are displayed. Pressing the "Change synchronization" button switches the state between Synchronous and Asynchronous.	
Current value	Monitors the feedback values after the unit system conversion for each axis. Click [Current value update] to display the dialog for inputting value to change the preset value.	13.4 Current Value Update
Unit	The units of position for each axis specified in the parameter settings are displayed.	
Deviation (pulse)	When the movement amount automatic check function is enabled, deviations are displayed. In the case of virtual axes, "0" is displayed when the function is not used.	13.6 Pulse Input
JOG target speed	Monitors and displays the target speed in the JOG operation. Click [Change] to change the target speed for the JOG operation.	9.1 Setting and Operation of JOG Operation
JOG [+]	Performs the JOG forward rotation while pressing [+].	
JOG [-]	Performs the JOG reverse rotation while pressing [-].	
Table No.	Displays the table number to perform the teaching. Click [Teaching] to change the table number for the teaching and register the current value.	5.5 Creating Positioning Data Table
Axis state	"Running" or "Stopped" is displayed. When an error has occurred, "Error occurred" is displayed.	
Error code	When an error has occurred, the latest error code is displayed. Pressing the "Clear errors" button clears errors.	15.1 About Errors and Warnings
Warning code	When a warning has occurred, the latest warning code is displayed. Pressing the "Clear warnings" button clears warnings.	
Speed rate	The target speed of the home return specified in the parameter settings for each axis is regarded as 100%, and the operation is executed in the specified speed rate. Clicking [Speed Rate] shows the dialog for inputting the value.	



◆ KEY POINTS

- If an recoverable error occurs in the positioning unit, click the [Error clear] button to clear the error.
- If a warning occurs in the positioning unit, click [Warning clear] to clear the warning.
- The control method for the table number that the teaching operation was performed is automatically changed to “Absolute”.
- The result of the teaching becomes effective once the tool operation quits and the setting data is downloaded to the positioning unit.
- This dialog cannot be closed while the positioning unit is in home return operation.

7

Automatic Operation (Positioning Control)

7.1 Basic Operation

7.1.1 Positioning Control Patterns

■ Type of operations

The automatic operation is an operation mode to perform positioning control. A single axis control and an interpolation control that starts and stops multiple axes simultaneously are available for positioning control.

End point (E-point) control, which uses the positioning data of a single table, and pass point (P-point) control and continuous point (C-point) control, both of which use multiple tables, are available for single axis control and interpolation control. These types of control are described below, and acceleration time and deceleration time can be set individually. For P-point control and C-point control, an E-point should be set as the last table. In P-point control and C-point control, the operation done flag turns ON after the last table is executed.

JOG positioning (J-point) control (i.e., speed control) is available in addition to P-point control, C-point control, and E-point control.

J-point control operates until the start contact of J-point positioning turns ON after the operation of the positioning unit starts, and the next positioning control will start when the start contact of J-point positioning turns ON.

In J-point control, the operation done flag turns ON after the last table is executed.

J-point control can be used for a single axis only.

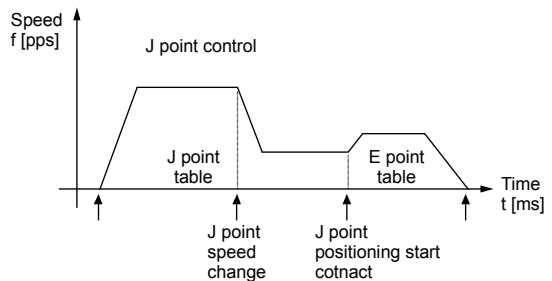
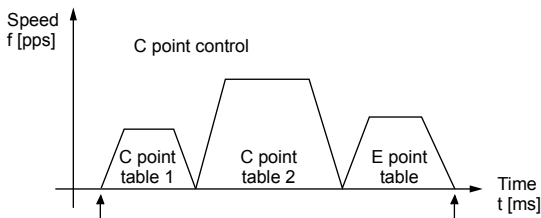
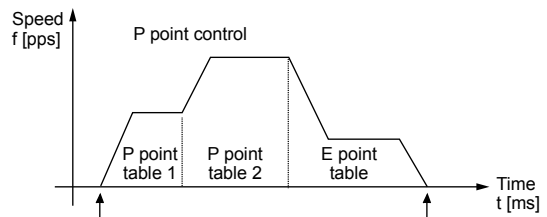
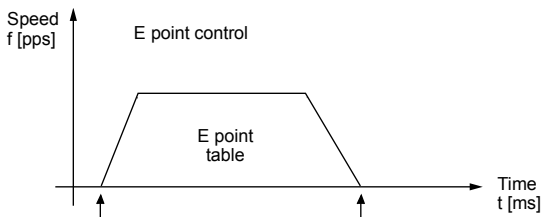

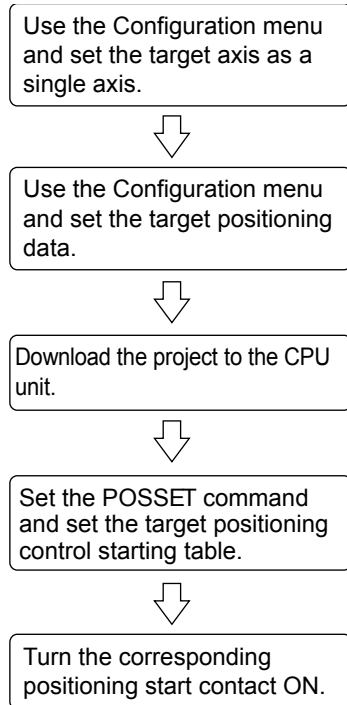
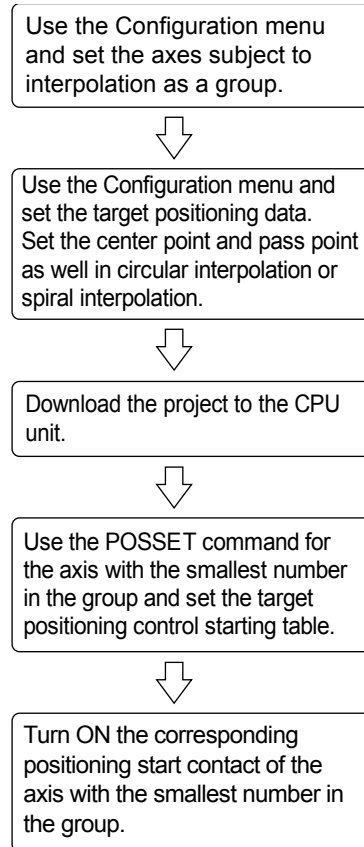
■ Operation flow of single axis control**■ Operation flow of interpolation control**

7.1.2 Setting and Operation of E-point Control

The example below is a case of single-axis control with the positioning unit installed in slot 1. The movement amount setting uses an increment method in pulses.

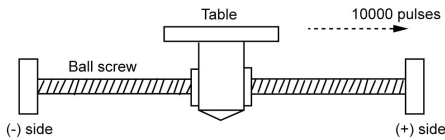

■ Settings

Items	Setting example
Operation pattern	E: End point
Control method	I: Increment
X-axis movement amount	10000 pulses
Acceleration/deceleration pattern	L: Linear
Acceleration time (ms)	100 ms
Deceleration time (ms)	100 ms
Target speed	10000 pps

■ Operation diagram

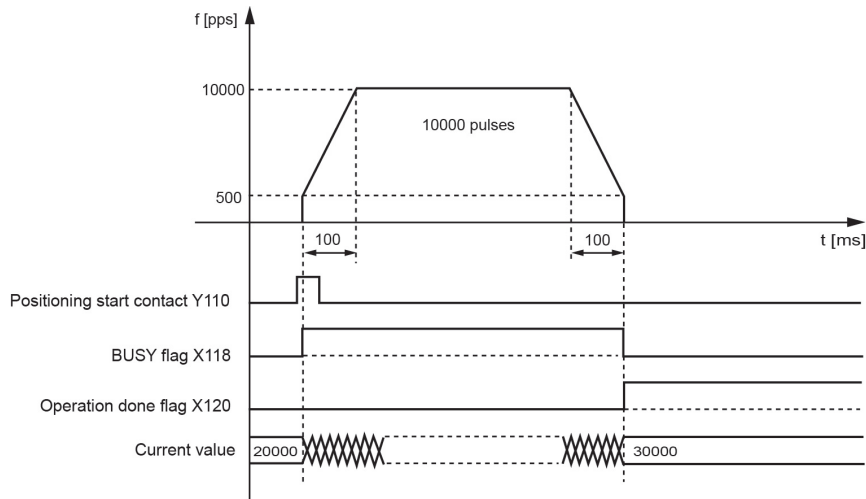

■ Operation of each contact

- The BUSY flag (X118), which indicates that the motor is running, will turn ON when the positioning control starts, and it will turn OFF when the operation completes.
- The operation done flag (X120), which indicates the completion of operation, will turn ON when the current operation is completed, and it will be held until the next positioning control, JOG operation, home return, or pulser operation starts. The flag will turn ON after the positioning unit transmits a reference for the target position.

7.1.3 Setting and Operation of P-point Control

The example below is a case of single-axis control with the positioning unit installed in slot 1. The movement amount setting uses an increment method in pulses.

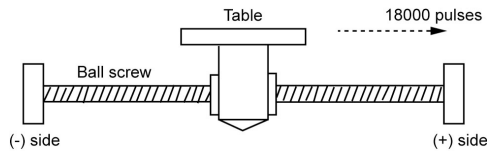

■ Settings

Items	Setting example		
	Table 1	Table 2	Table 3
Operation pattern	P: Pass point	P: Pass point	E: End point
Control method	I: Increment	I: Increment	I: Increment
X-axis movement amount	5000 pulses	10000 pulses	3000 pulses
Acceleration/deceleration pattern	L: Linear	L: Linear	L: Linear
Acceleration time (ms)	100 ms	200 ms	30 ms
Deceleration time (ms)	10 ms	20 ms	150 ms
Target speed	10000 pps	20000 pps	5000 pps

■ Operation diagram

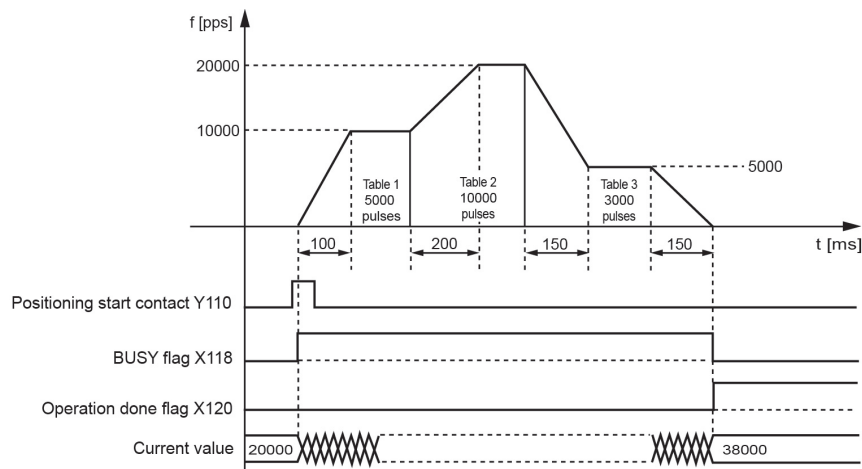

■ Operation of each contact

- The BUSY flag (X118), which indicates that the motor is running, will turn ON when the positioning control starts, and it will turn OFF when the operation completes.
- The operation done flag (X120), which indicates the completion of operation, will turn ON when the current operation is completed, and it will be held until the next positioning control, JOG operation, home return, or pulser operation starts. The flag will turn ON after the positioning unit transmits a reference for the target position.

7.1.4 Setting and Operation of C-point Control

The example below is a case of single-axis control with the positioning unit installed in slot 1. The movement amount setting uses an increment method in pulses.

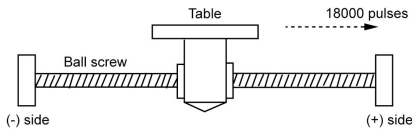

■ Settings

Use the tool software to make positioning data and parameter settings. The unit is set to pulse.

Items	Setting example		
	Table 1	Table 2	Table 3
Operation pattern	C: Continuance point	C: Continuance point	E: End point
Control method	I: Increment	I: Increment	I: Increment
X-axis movement amount	5000 pulses	10000 pulses	3000 pulses
Acceleration/deceleration pattern	L: Linear	L: Linear	L: Linear
Acceleration time (ms)	100 ms	200 ms	30 ms
Deceleration time (ms)	10 ms	20 ms	150 ms
Target speed	10000 pps	20000 pps	5000 pps

■ Operation diagram

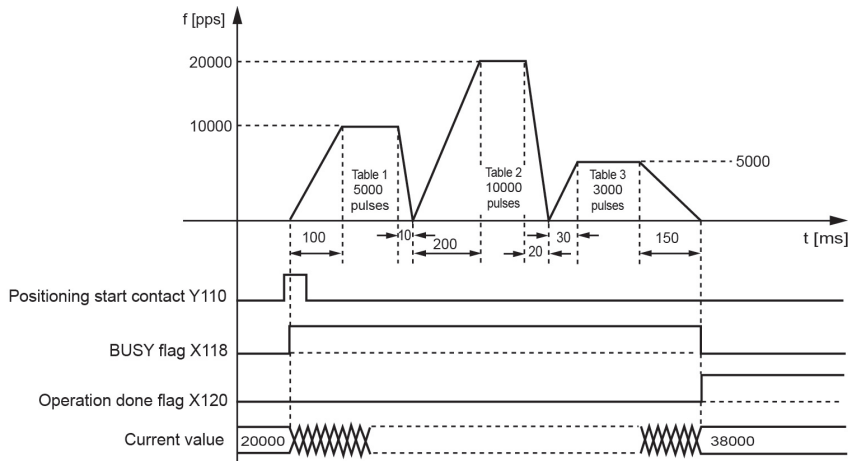

■ Operation of each contact

- The BUSY flag (X118), which indicates that the motor is running, will turn ON when the positioning control starts, and it will turn OFF when the operation completes.
- The operation done flag (X120), which indicates the completion of operation, will turn ON when the current operation is completed, and it will be held until the next positioning control, JOG operation, home return, or pulser operation starts. The flag will turn ON after the positioning unit transmits a reference for the target position.

7.1.5 Setting and Operation of J-point Control

- JOG positioning (J-point) control operates at target speed until the start contact of J-point positioning turns ON after the operation of the positioning unit starts, and the next positioning control will start when the start contact of J-point positioning turns ON.

■ Settings

Items	Setting example			
	Table 1	J-point axis parameter setting	Table 2	Table 3
Operation pattern	J: Speed point	–	P: Pass point	E: End point
Control method	I: Increment	–	I: Increment	I: Increment
X-axis movement amount	5000 pulses	–	10000 pulses	3000 pulses
Acceleration/deceleration pattern	L: Linear	–	L: Linear	L: Linear
Acceleration time (ms)	100 ms	–	200 ms	30 ms
Deceleration time (ms)	10 ms	–	20 ms	150 ms
Target speed	10000 pps	–	20000 pps	5000 pps
J-point operation setting code	–	Linear acceleration/ deceleration	–	–
J-point acceleration time (ms)	–	10 ms	–	–
J-point deceleration time (ms)	–	10 ms	–	–
J-point target speed	–	30000 pps	–	–



◆ KEY POINTS

- **Specify parameters for the start of operation in the positioning data table. Specify parameters in the axis parameter-setting menu at the time of speed change.**
- **J-point control can be used for single-axis control only. It is not available for interpolation control.**
- **Set the positioning unit to increment mode to implement P-point control, C-point control, or E-point control with positions specified after J-point control is implemented.**
- **Speed control is performed while the positioning unit is in J-point control, in which case, be sure to input the amount of movement for positioning with a value that can secure a target constant-speed area.**

■ Operation diagram

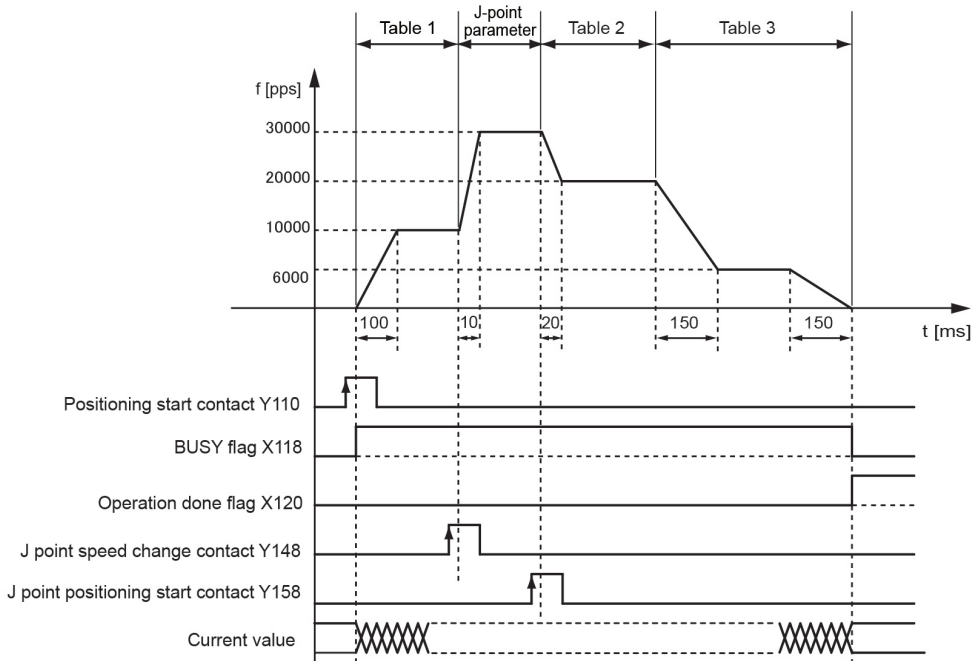

■ Operation of each contact

- The BUSY flag (X118) will turn ON when the operation starts and turn OFF when the operation is completed.
- The operation done flag (X120) indicating the state that an operation completed will turn ON when the JOG operation is completed, and it will be held until the next positioning control, JOG operation, home return, or pulser operation starts.
- The target speed will be changed when the J-point speed change contact (Y148) turns ON. The change will be enabled at the edge where the contact turns ON.
- Positioning control will start when J-point positioning start contact (Y158) turns ON.

■ Behaviors when the speed change contact turns ON while the positioning unit is accelerating or decelerating the speed

- A speed change is possible during J-point control, but impossible during acceleration or deceleration.
- A speed change will be made after the positioning unit goes to constant speed when the speed change signal turns ON during acceleration or deceleration.

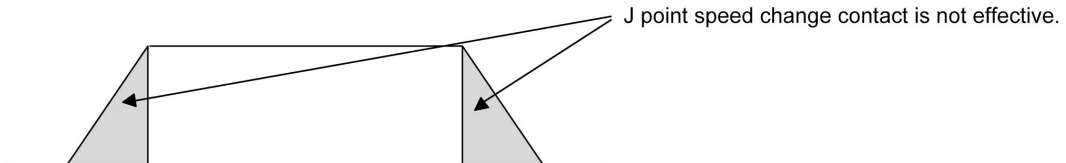

7.1.6 Sample Program (E-point, P-point, and C-point Control)

■ Sample program

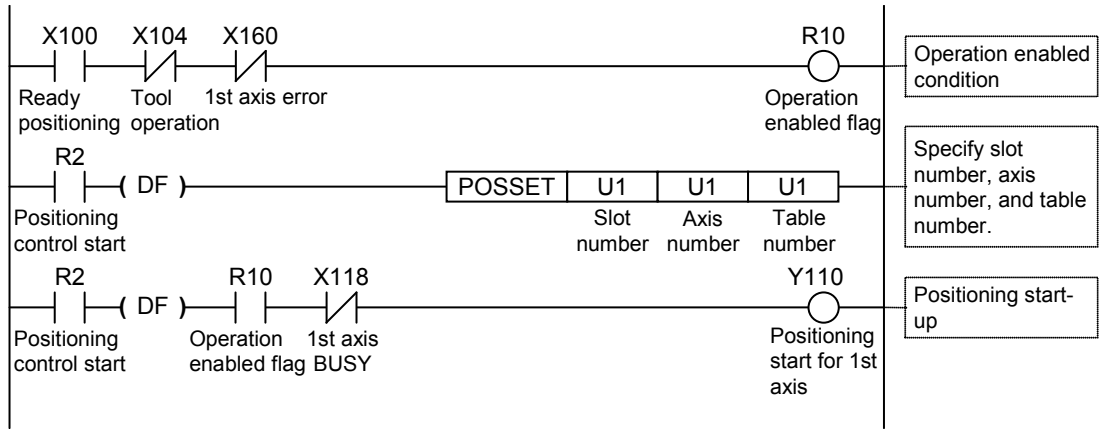

7.1.7 Sample Program (J-point Control)

■ Sample program

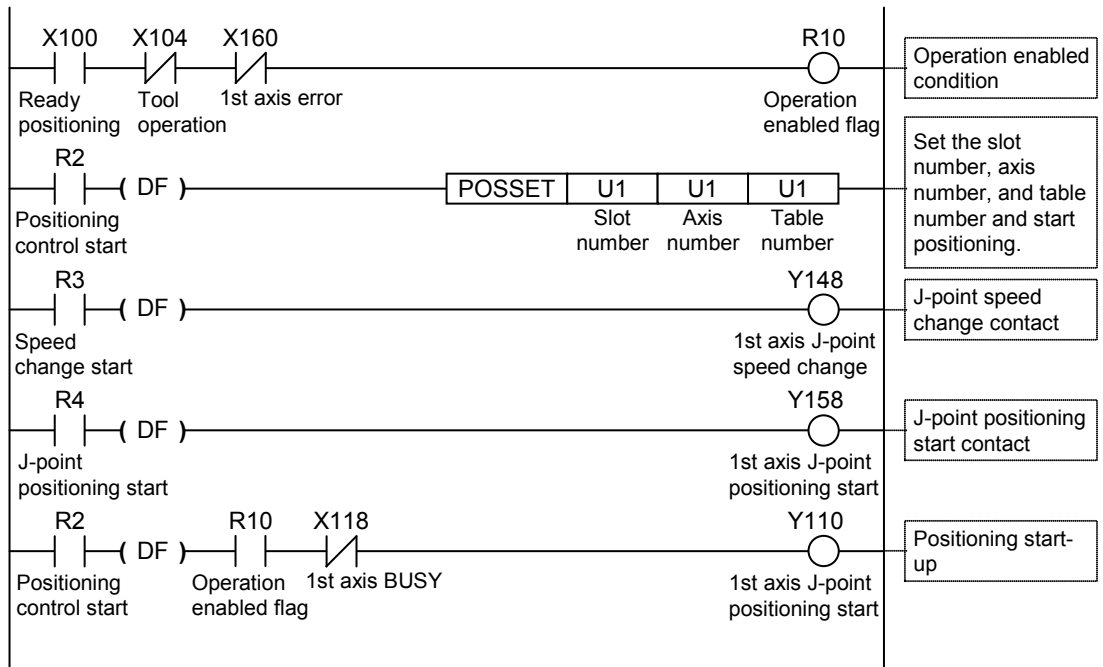

7.1.8 Programming Precautions

■ **Programming Precautions**

- The last table should be set to E: End point.
- If any value such as a movement amount, acceleration time, deceleration time or target speed is out of the specified range, a set value error will occur when the positioning control starts.
- The start contact and flag number varies depending on the number of axes and the installation position of the unit.
- The specified slot number varies depending on the installation position of the unit.

■ **Operation at limit input**

Condition	Direction	Limit status	Operation
At each control start	Forward rotation	Limit input (+):ON	Not executable, Error occurs.
		Limit input (-):ON	Not executable, Error occurs.
	Reverse rotation	Limit input (+):ON	Not executable, Error occurs.
		Limit input (-):ON	Not executable, Error occurs.
During each type of control	Forward rotation	Limit input (+):ON	Deceleration stop, Error occurs.
	Reverse rotation	Limit input (-):ON	Deceleration stop, Error occurs.

7.2 Interpolation Control

7.2.1 Types of Interpolation Control

■ Types of operations

Interpolation control includes 2-axis linear interpolation control, 2-axis circular interpolation control, 3-axis linear interpolation control, and 3-axis spiral interpolation control. The following methods are available to specify the operation of each interpolation control. Select an appropriate method according to the application. The axes in the relation of interpolation are called X-axis and Y-axis for the 2-axis interpolation, and are called X-axis, Y-axis, and Z-axis for the 3-axis interpolation. X-, Y-, and Z-axes are automatically assigned in ascending order of axis signal levels.

In each type of interpolation control, the E-point control that uses one table, P-point control and C-point control that uses multiple tables can be combined arbitrarily as positioning data.

For example, using P-point control enables continuous interpolation control from 2-axis linear control to 2-axis circular interpolation control. The acceleration time and deceleration time can be specified individually. For P-point control and C-point control, an E point should be set as the last table.

Type	Operation specification method	Necessary data
2-axis linear interpolation control	Composite speed	Composite speed of X-axis and Y-axis
	Long axis speed	Speed of long axis (Axis of which moving distance is long)
2-axis circular interpolation control	Center/CW direction	X-axis and Y-axis coordinates of center
	Center specified/CCW direction	X-axis and Y-axis coordinates of center
	Pass point	X-axis and Y-axis coordinate of pass point on arc
3-axis linear interpolation control	Composite speed	Composite speed of X-axis, Y-axis, and Z-axis
	Long axis speed	Speed of long axis (Axis of which moving distance is long)
3-axis spiral interpolation control	Center/CW direction/X-axis movement	Y-axis and Z-axis coordinates of center
	Center/CCW direction/Y-axis movement	Y-axis and Z-axis coordinates of center
	Center/CW direction/Y-axis movement	X-axis and Z-axis coordinates of center
	Center/CCW direction/Y-axis movement	X-axis and Z-axis coordinates of center
	Center/CW direction/Z-axis movement	X-axis and Y-axis coordinates of center
	Center/CCW direction/Z-axis movement	X-axis and Y-axis coordinates of center
	Pass point/X-axis movement	Y-axis and Z-axis coordinate of pass point on arc
	Pass point/Y-axis movement	X-axis and Z-axis coordinate of pass point on arc
	Pass point/Z-axis movement	X-axis and Y-axis coordinate of pass point on arc

Automatic Operation (Positioning Control)

2-axis linear interpolation
(Composite speed specification)

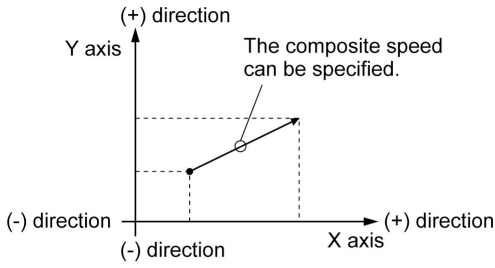

2-axis linear interpolation
(Long axis speed specification)

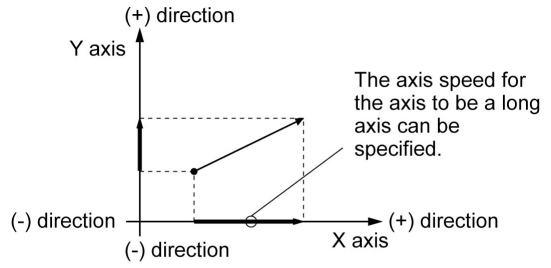

2-axis circular interpolation
(Center point specification/CW direction)

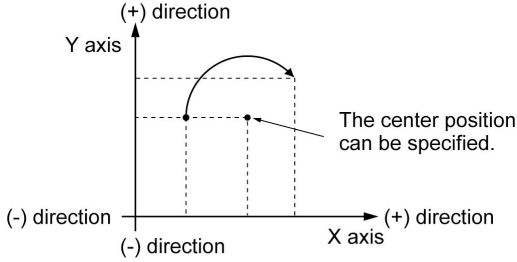

2-axis circular interpolation
(Center point specification/CCW direction)

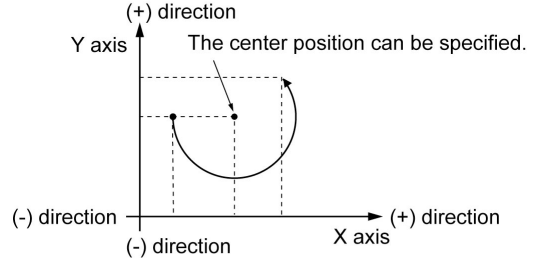

2-axis circular interpolation
(Pass point point specification)

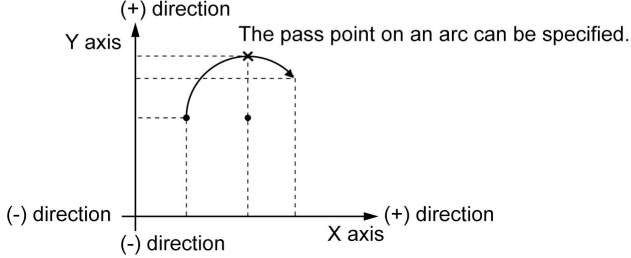

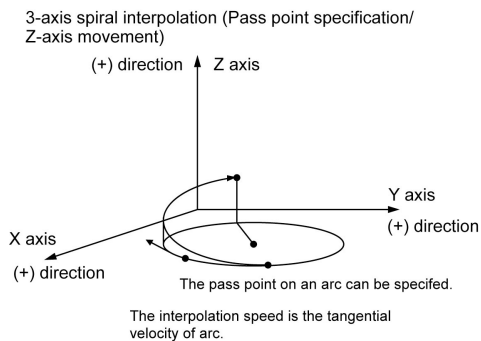
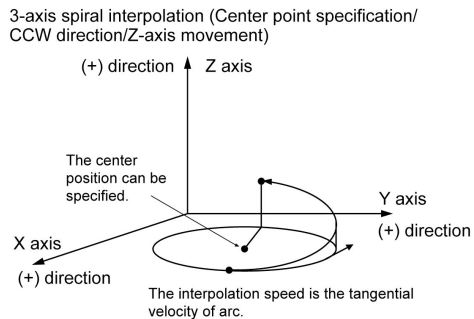
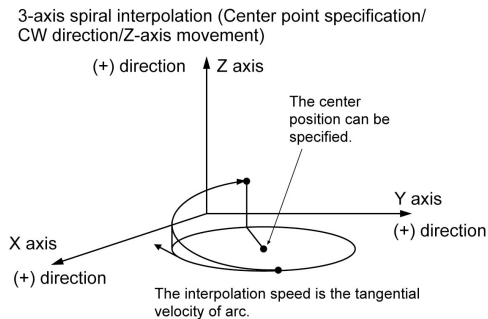
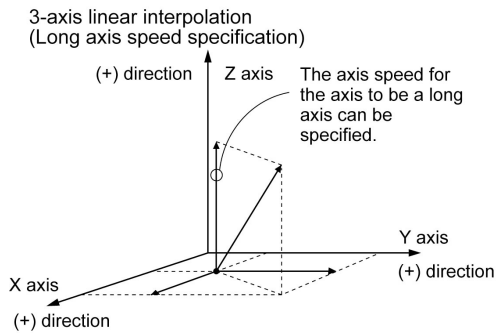
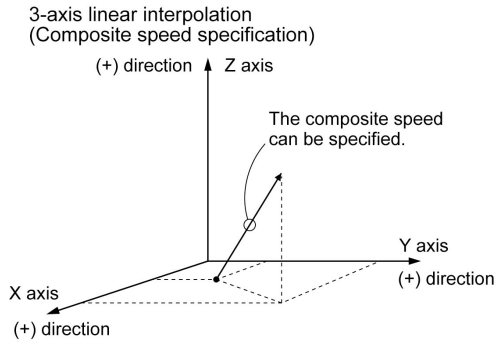

When the X-axis and Y-axis is the moving axes, each axis in the above diagram is replaced.

7.2.2 Setting and Operation of 2-Axis Linear Interpolation

The example below is a case of E-point control with the positioning unit installed in slot 1. The X-axis is set to the 1st axis and the Y-axis is set to the 2nd axis. The movement amount setting is the increment method in pulses.

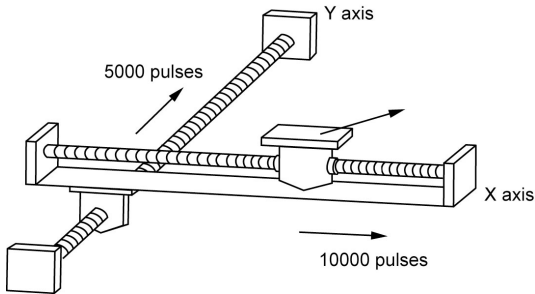

■ Settings

Items	Setting example
Operation pattern	E: End point
Interpolation operation	0: Linear (Composite speed)
Control method	I: Increment
X-axis movement	10000 pulses
X-axis auxiliary point	0
Y-axis movement	5000 pulses
Y-axis auxiliary point	0
Acceleration/deceleration method	L: Linear
Acceleration time (ms)	100 ms
Deceleration time (ms)	100 ms
Interpolation speed	10000 pps

■ Operation diagram

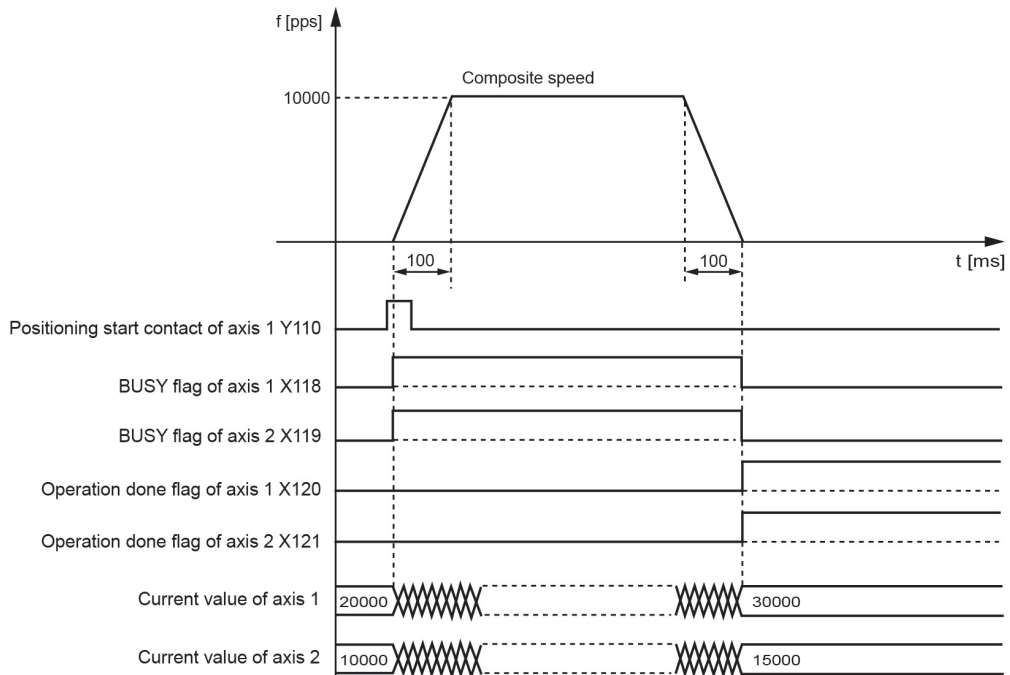

■ Operation of each contact

- The 1st axis and 2nd axis BUSY flags (X118 and X119) indicating the state that a motor is running will turn ON when the positioning control starts, and they will turn OFF when the operation completes.
- The 1st axis and 2nd axis operation done flags (X120 and X121) indicating the state that an operation completed will turn ON when the JOG operation is completed, and they will be held until the next positioning control, JOG operation, home return, or pulser operation starts.

■ Programming Precautions

- To start the interpolation control, turn ON the positioning start contact of the axis with the smallest number in the same group.
- The values of the X-axis auxiliary point and Y-axis auxiliary point are invalid for the linear interpolation.
- In the case of specifying long axis speed, the composite speed will be faster than the long axis speed.
- If any value such as a movement amount, acceleration time, deceleration time or target speed is out of the specified range, a set value error will occur when the positioning control starts.
- The start contact and flag number varies depending on the number of axes and the installation position of the unit.
- The specified slot number varies depending on the installation position of the unit.

7.2.3 Setting and Operation of 2-Axis Circular Interpolation

The example below is a case of E-point control with the positioning unit installed in slot 1. The X-axis is set to the 1st axis and the Y-axis is set to the 2nd axis. The movement amount setting is the increment method in pulses.

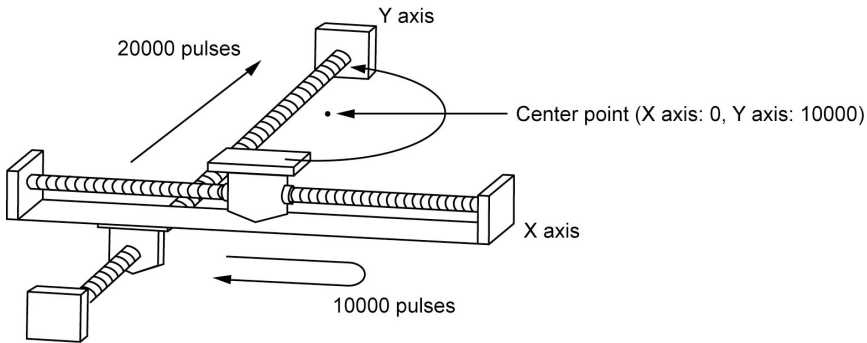

■ Settings

Use the tool software to make positioning data and parameter settings. The unit is set to pulse.

Items	Setting example
Operation pattern	E: End point
Interpolation operation	S: Circular (Pass point/CW direction)
Control method	I: Increment
X-axis movement	0 pulse
X-axis auxiliary point	0 pulse
Y-axis movement	20000 pulses
Y-axis auxiliary point	10000 pulses
Acceleration/deceleration pattern	L: Linear
Acceleration time (ms)	100 ms
Deceleration time (ms)	100 ms
Interpolation speed	10000 pps

■ Operation diagram

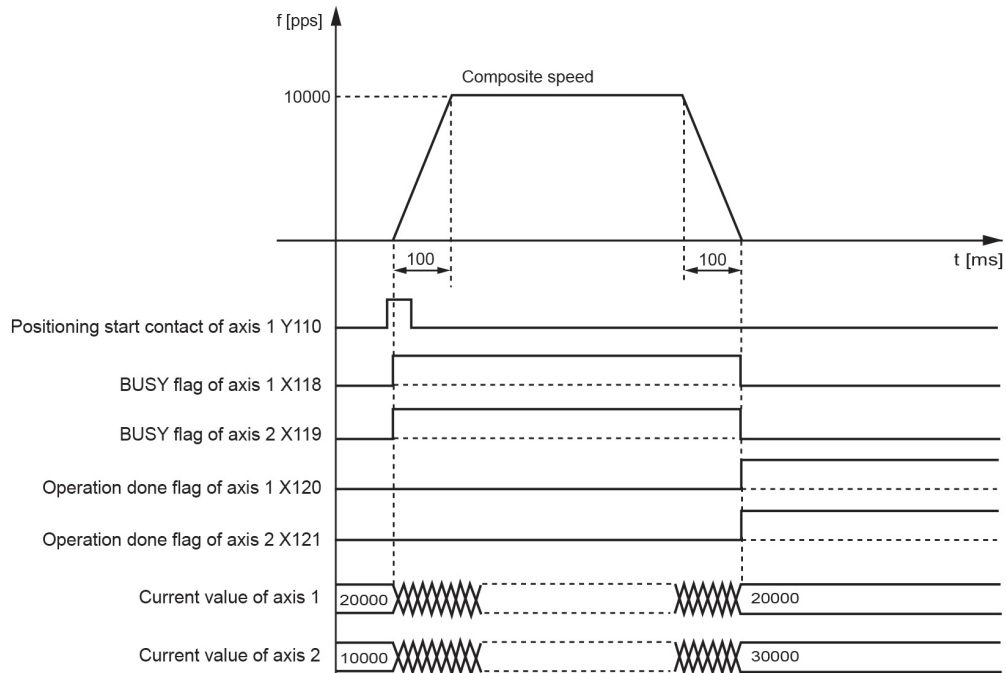

■ Operation of each contact

- The 1st axis and 2nd axis BUSY flags (X118 and X119) indicating the state that a motor is running will turn ON when the positioning control starts, and they will turn OFF when the operation completes.
- The 1st axis and 2nd axis operation done flags (X120 and X121) indicating the state that an operation completed will turn ON when the JOG operation is completed, and they will be held until the next positioning control, JOG operation, home return, or pulser operation starts.

■ Programming Precautions

- To start the interpolation control, turn ON the positioning start contact of the axis with the smallest number in the same group.
- In the case of the center point specification, the X-axis auxiliary point is the center point of X-axis, and the Y-axis auxiliary point is the center point of Y-axis. In the case of the pass point, each pass point is set as the pass point of X-axis and Y-axis.
- When the control method is increment, both the center point and pass point will be increment coordinates from the start point.
- When the start point and the operation done point is the same, it performs one circular operation when using the center point method. However, when using the pass point method, an error will occur.
- In the case of the pass point method, when the start point, pass point, and operation done point exist in the same straight line, an arc will not be comprised and an error will occur.
- In the case of specifying long axis speed, the composite speed will be faster than the long axis speed.
- If any value such as a movement amount, acceleration time, deceleration time or target speed is out of the specified range, a set value error will occur when the positioning control starts.
- The start contact and flag number varies depending on the number of axes and the installation position of the unit.
- The specified slot number varies depending on the installation position of the unit.

7.2.4 Setting and Operation of 3-Axis Linear Interpolation

The example below is a case of E-point control with the positioning unit installed in slot 1. The X-axis is set to the 1st axis, the Y-axis is set to the 2nd axis, and the Z-axis is set to the 3rd axis. The movement amount setting is the increment method, and the unit is set to pulse.

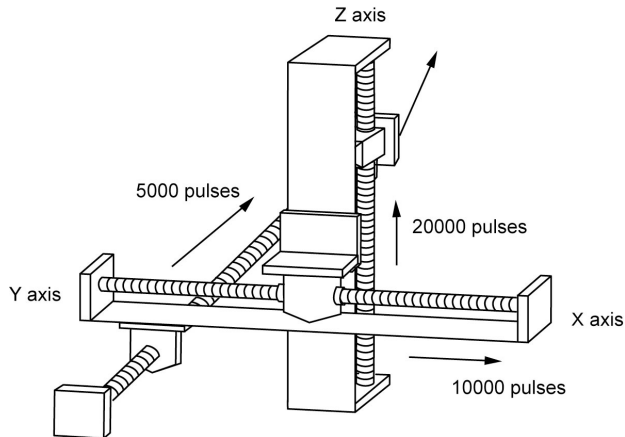

■ Settings

Items	Setting example
Operation pattern	E: End point
Interpolation operation	0: Linear (Composite speed)
Control method	I: Increment
X-axis movement amount	10000 pulses
X-axis auxiliary point	0
Y-axis movement amount	5000 pulses
Y-axis auxiliary point	0
Z-axis movement amount	20000 pulses
Z-axis auxiliary point	0
Acceleration/deceleration pattern	L: Linear
Acceleration time (ms)	100 ms
Deceleration time (ms)	100 ms
Interpolation speed	10000 pps

■ Operation diagram

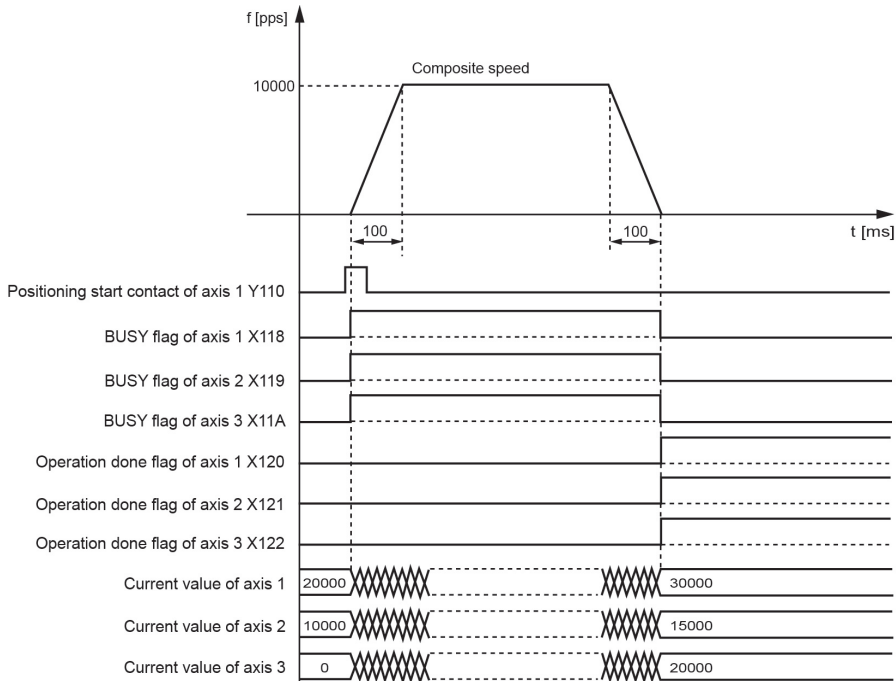

■ Operation of each contact

- The 1st axis, 2nd axis, and 3rd axis BUSY flags (X118, X119, and X11A) indicating the state that a motor is running will turn ON when the positioning control starts, and they will turn OFF when the operation completes.
- The 1st axis, 2nd axis, and 3rd axis operation done flags (X120, X121, and X122) indicating the state that an operation completed will turn ON when the JOG operation is completed, and they will be held until the next positioning control, JOG operation, home return, or pulser operation starts.

■ Programming Precautions

- To start the interpolation control, turn ON the positioning start contact of the axis with the smallest number in the same group.
- The values of the X-axis auxiliary point and Y-axis auxiliary point are invalid for the linear interpolation.
- In the case of specifying long axis speed, the composite speed will be faster than the long axis speed.
- If any value such as a movement amount, acceleration time, deceleration time or target speed is out of the specified range, a set value error will occur when the positioning control starts.
- The start contact and flag number varies depending on the number of axes and the installation position of the unit.
- The specified slot number varies depending on the installation position of the unit.

7.2.5 Setting and Operation of Three-Axis Linear Interpolation

The example below is a case of E-point control with the positioning unit installed in slot 1. The X-axis is set to the 1st axis, the Y-axis is set to the 2nd axis, and the Z-axis is set to the 3rd axis. The movement amount setting is the increment method, and the unit is set to pulse.

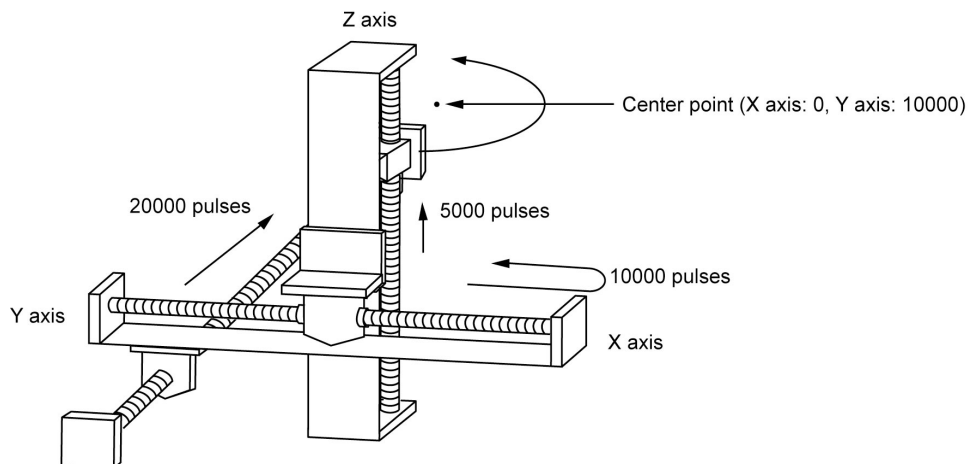

■ Settings

Items	Setting example
Operation pattern	E: End point
Interpolation operation	E: Spiral (Center/CW direction/Z-axis movement)
Control method	I: Increment
X-axis movement amount	0 pulse
X-axis auxiliary point	0 pulse
Y-axis movement amount	20000 pulses
Y-axis auxiliary point	10000 pulses
Z-axis movement amount	5000 pulses
Z-axis auxiliary point	0
Acceleration/deceleration pattern	L: Linear
Acceleration time (ms)	100 ms
Deceleration time (ms)	100 ms
Interpolation speed	10000 pps

■ Operation diagram

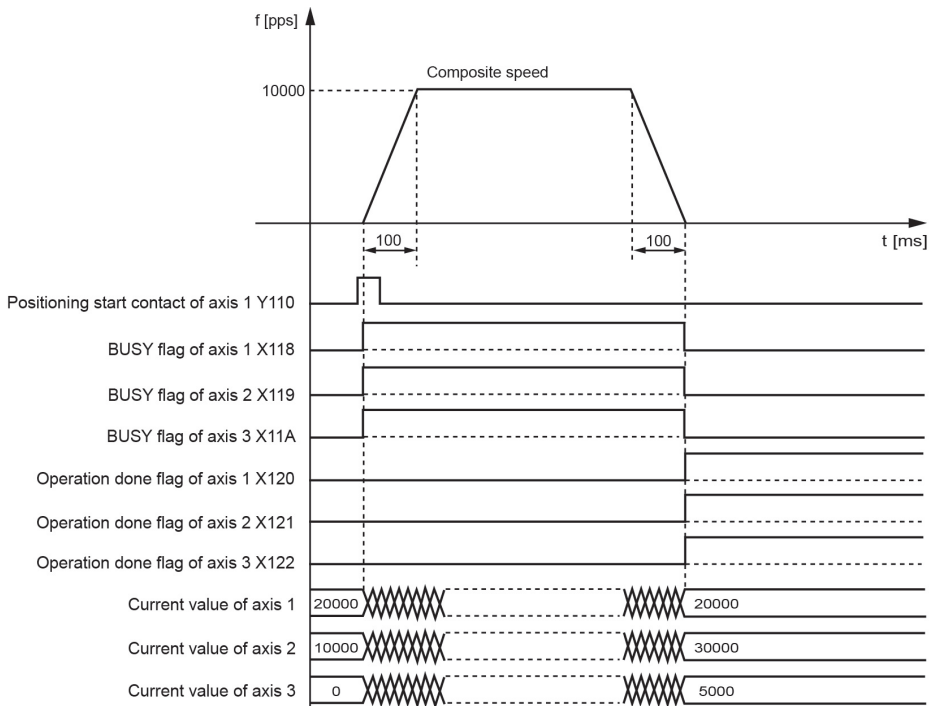

■ Operation of each contact

- The 1st axis, 2nd axis, and 3rd axis BUSY flags (X118, X119, and X11A) indicating the state that a motor is running will turn ON when the positioning control starts, and they will turn OFF when the operation completes.
- The 1st axis, 2nd axis, and 3rd axis operation done flags (X120, X121, and X122) indicating the state that an operation completed will turn ON when the JOG operation is completed, and they will be held until the next positioning control, JOG operation, home return, or pulser operation starts.

■ Programming Precautions

- For X-Y plane, in the case of the center point specification, the X-axis auxiliary point is the center point of X-axis, and the Y-axis auxiliary point is the center point of Y-axis. In the case of the pass point, each pass point is set as the pass point of X-axis and Y-axis. These settings are the same for Y-Z plane and X-Z plane.
- When the control method is increment, both the center point and pass point will be increment coordinates from the start point.
- When the start point and the operation done point is the same, it performs one circular operation when using the center point method. However, when using the pass point method, an error will occur.
- In the case of the pass point method, when the start point, pass point, and operation done point exist in the same straight line, an arc will not be comprised and an error will occur.
- In the case of specifying long axis speed, the composite speed will be faster than the long axis speed.
- If any value such as a movement amount, acceleration time, deceleration time or target speed is out of the specified range, a set value error will occur when the positioning control starts.
- The start contact and flag number varies depending on the number of axes and the installation position of the unit.
- The specified slot number varies depending on the installation position of the unit.

7.2.6 Sample Program (Interpolation Control)

An example of 3-axis interpolation control is shown below.

■ Sample program

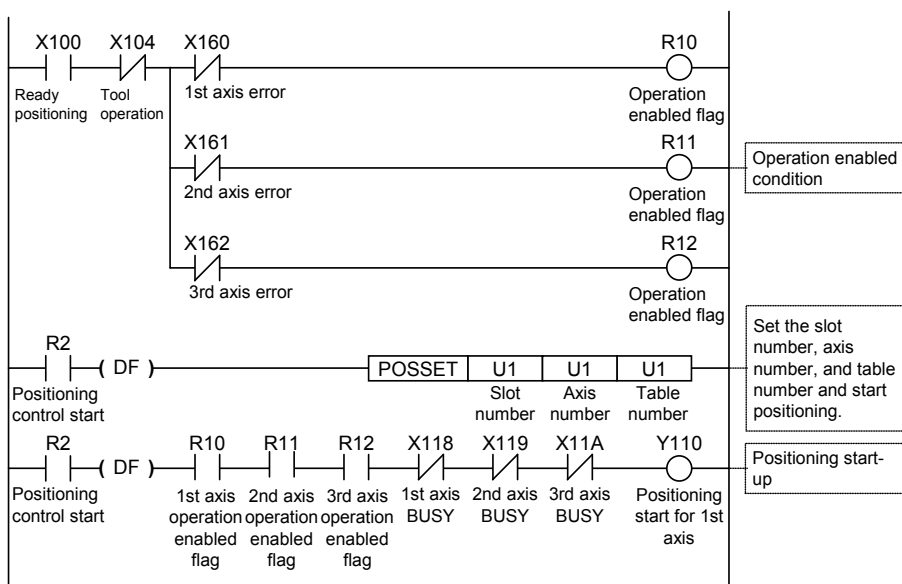

7.3 Setting and Operation of Positioning Repeat Function

The positioning repeat function enables continuous positioning control according to the number of repetitions specified.

The number of repetitions is set in the area for the number of positioning repetitions on each axis. The number of repetitions can be set within a range of 2 to 254. It is possible to specify a limitless number of repetitions by setting 255 for the area of the number of positioning repetitions.

■ Overview of Positioning repeat function

The positioning unit operates as shown below in the case of repeating positioning control three times.

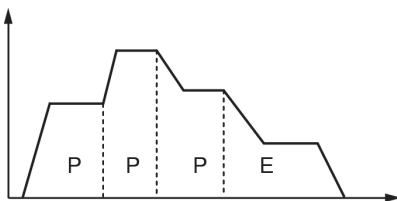

If a dwell time of 0 is set for E-point control, i.e., the end point of positioning control, the positioning unit will perform E-point control as P-point control, and complete positioning control after repeating positioning control three times continuously.

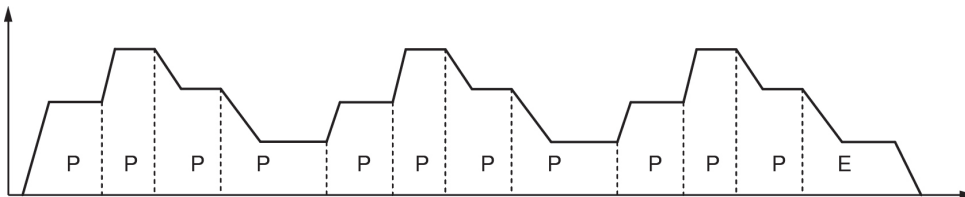

If the dwell time is set to a value other than 0 for E-point control, i.e., the end point of positioning control, the control unit will perform E-point control as C-point control, and repeat positioning control with a pause specified by the dwell time (ms). The positioning unit will finish operating after repeating positioning control three times.

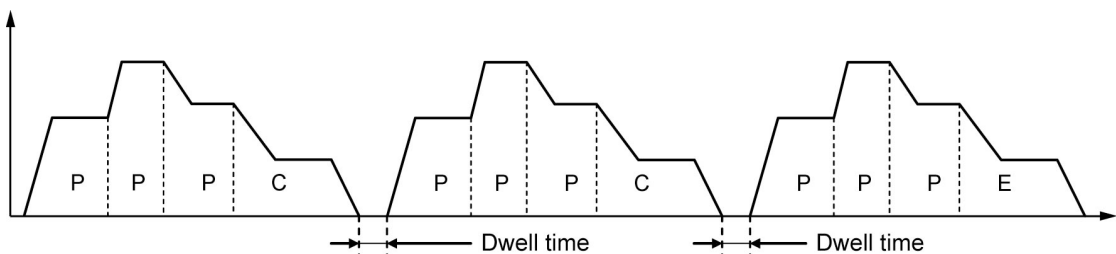

■ Setting area for positioning repeat function

Set the number of repetitions of positioning control per axis before starting positioning control. The positioning unit repeats positioning control for the number of repetitions set and finishes operating. The number of repetitions will be reset to the default value on completion of positioning control.

Unit memory no. (Hex)	Name	Description	Default	Setting range	Set unit
UM 00108	Number of 1st axis positioning repetitions	Stores the number of repetitions starting from the starting table number of positioning control of the 1st axis until the E point. If 255 is stored, the positioning unit repeats positioning control an unlimited number of times until you manually stop the operation.	0	0 to 255	Times
UM 00109	Number of 2nd axis positioning repetitions	Stores the number of repetitions starting from the starting table number of positioning control of the 2nd axis until the E point. If 255 is stored, the positioning unit repeats positioning control an unlimited number of times until you manually stop the operation.	0	0 to 255	Times
UM 0010A	Number of 3rd axis positioning repetitions	Stores the number of repetitions starting from the starting table number of positioning control of the 3rd axis until the E point. If 255 is stored, the positioning unit repeats positioning control an unlimited number of times until you manually stop the operation.	0	0 to 255	Times
UM 0010B	Number of 4th axis positioning repetitions	Stores the number of repetitions starting from the starting table number of positioning control of the 4th axis until the E point. If 255 is stored, the positioning unit repeats positioning control an unlimited number of times until you manually stop the operation.	0	0 to 255	Times
UM 0010F	Number of virtual axis positioning repetitions	Stores the number of repetitions starting from the starting table number of positioning control of the virtual axis until the E point. If 255 is stored, the positioning unit repeats positioning control an unlimited number of times until you manually stop the operation.	0	0 to 255	Times

■ Interruption of repetitive positioning

The following operation will occur only if the positioning unit in repetitive positioning control is decelerated to stop.

Automatic Operation (Positioning Control)

• Repeating E-point control (with dwell time: 0 ms)

When the positioning unit detects a deceleration stop, the positioning unit will come to a stop after repeating positioning control N+2 times.

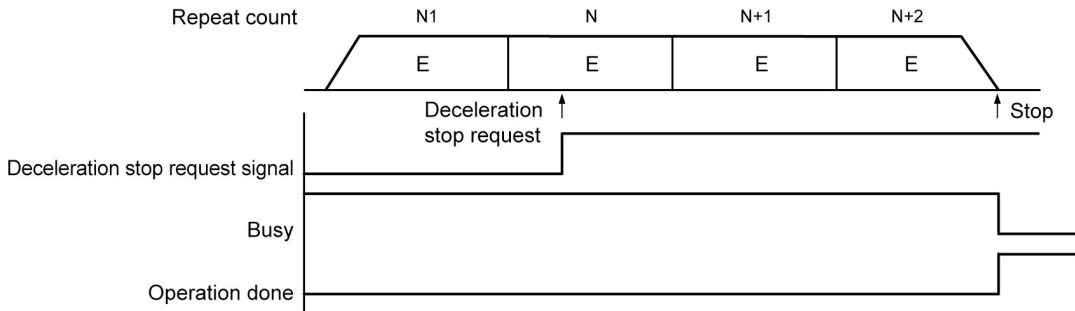

• Implementing a number of positioning tables continuously

When the positioning unit detects a deceleration stop, the positioning unit will come to a stop after repeating positioning control N+1 times.

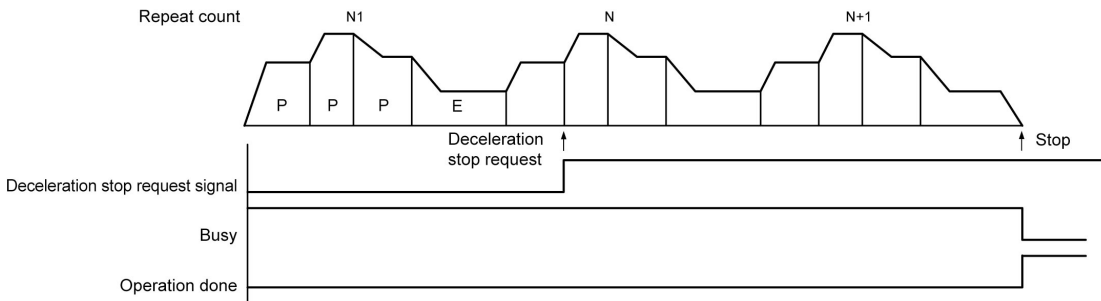

The example below is a case of single-axis control with the positioning unit installed in the slot 1. The movement amount setting uses an increment method in pulses.

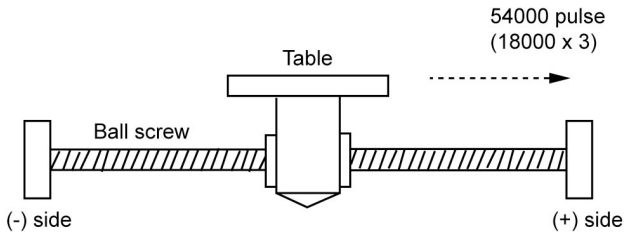

■ Settings

Items	Setting example		
	Table 1	Table 2	Table 3
Operation pattern	P: Pass point	P: Pass point	E: End point
Control method	I: Increment	I: Increment	I: Increment
X-axis movement amount	5000 pulses	10000 pulses	3000 pulses
Acceleration/deceleration pattern	L: Linear	L: Linear	L: Linear
Acceleration time (ms)	100 ms	200 ms	30 ms
Deceleration time (ms)	10 ms	20 ms	150 ms
Target speed	10000 pps	20000 pps	5000 pps
Dwell Time (ms)	0 ms	0 ms	0 ms
Number of positioning repetitions	3 (written to the setting area of the unit memory)		

■ Operation diagram

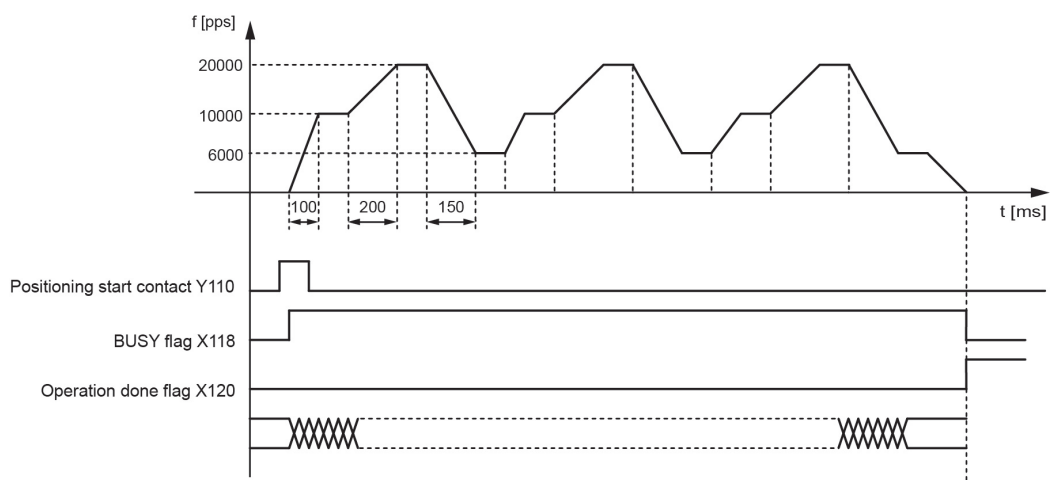

■ Operation of each contact

- The BUSY flag (X118), which indicates that the motor is running, will turn ON when the positioning control starts, and it will turn OFF when the operation completes.
- The operation done flag (X120), which indicates the completion of operation, will turn ON when the current operation is completed, and it will be held until the next positioning control, JOG operation, home return, or pulser operation starts.

Automatic Operation (Positioning Control)

Sample program

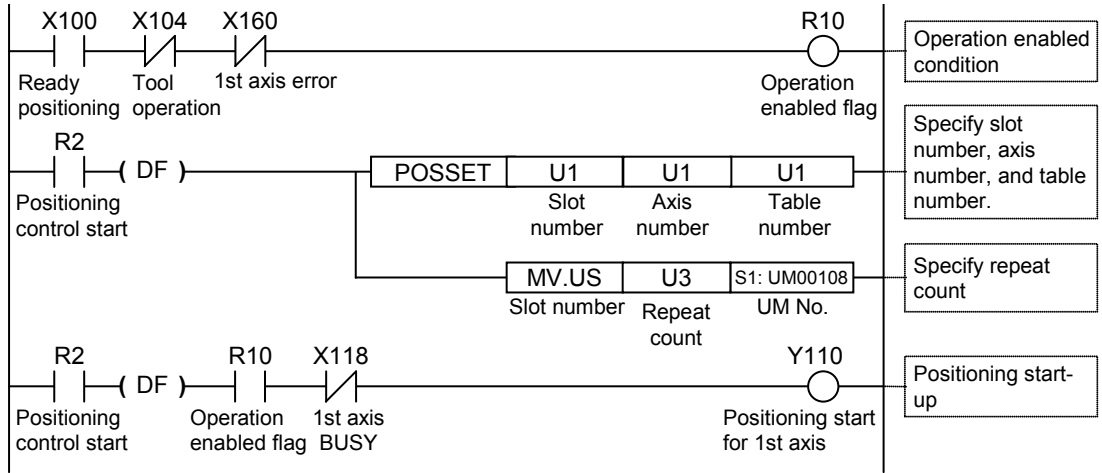

8

Automatic Operation (Synchronous Control)

8.1 Synchronous Control

8.1.1 Outline of Synchronous Control

■ Synchronous control

The positioning unit in synchronous control operates a master axis so that slave axes will operate in synchronization with the master axis. The use of synchronous control provides the following merits.

1. Ease of setting

A number of related axes can be operated with ease by designing the operation of the axes based on the master axis.

2. Ensuring operational safety

If an axis comes to a stop for some reason while the positioning unit is in synchronous control, all the relevant axes under synchronous control will come to a stop. Therefore, you can easily increase the safety of the positioning unit.

■ Outline of Synchronous Control

The synchronous control provides the following functions. These functions are executed in order, and the slave axes operate according to the operation result of each function.

Functions	Outline
Electronic gear	The number of pulses multiplied by the preset electronic gear ratio is output according to the operation of the master axis.
Electronic clutch	The operation of the slave axes can be separated from the operation of the master axis by disengaging the clutch.
Electronic cam	A function to output pulses according to the preset cam pattern. Calculates the operation phase of the master axis and outputs cam pulses according to the phase. The cam pattern is set with a setting tool.

■ Execution Order of Synchronous Control and Setting Procedures

The following section provides information on the outline of functions achieved by synchronous control and setting procedures for the functions.

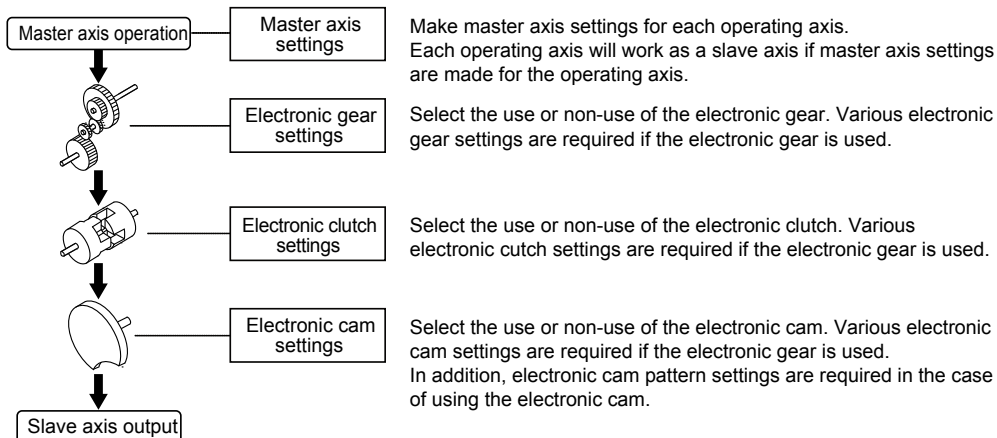

8.2 Settings for Master and Slave Axes

8.2.1 Selection of Master Axis and Settings

The master axis serves as a reference for synchronization control. Start and stop requests for various operations are made to the master axis under synchronous control. It is possible to select one of the following master axes.

■ Types of master axis

Type	Outline
Existing axis	<p>Axes (the 1st to 4th axes) available for the positioning unit.</p> <p>Use one of them if the master axis needs to be an object of control as well.</p> <p>If an existing axis is used as the master axis, the rest of the existing axes (three axes) can be used as slave axes.</p>
Virtual axis	<p>A virtual axis exists in the positioning unit.</p> <p>The existing axes (1st to 4th axes) can be used effectively if the virtual axis is used.</p> <p>The virtual axis cannot output pulses externally.</p> <p>The virtual axis cannot receive any external input signals, either.</p>
Pulse input	<p>The master axis operates according to pulse value input into the positioning unit.</p> <p>Use pulse input in the case of connecting an external device, such as an encoder, for the reference of synchronous control.</p> <p>In the case of using pulse input as the master axis, the slave axes will operate according to the pulse input. Therefore, be careful when starting or stopping the operation of the positioning unit.</p>

■ Types and restrictions of master axis

		Type		
		Existing axis	Virtual axis	Pulse input
Home return		Yes	Available to data setting only.	No
JOG operation		Yes	Yes	No
Positioning	Single axis	Yes	Yes	No
	Interpolation	Yes	No Available to single axis only.	No
Stop functions	System/Emergency/ Deceleration stop	Yes	Yes	No
	Limit stop	Yes	Questionable Stops only with software limit because of no limit signal input.	No
	Error stop	Yes	Yes	No
Others			Necessary to make settings to use the virtual axis on the Configuration screen.	Synchronizes with external pulse input, and no master axis control is possible. To stop synchronous control, stop the slave axes.



◆ KEY POINTS

- While the positioning unit is in synchronous control, slave axes set to use the master axis will operate only in synchronization with the master axis, i.e., the slave axes cannot operate independently.
- The virtual axis is assigned to a single axis only. In the case of using the virtual axis, check the box for the virtual axis in the dialog box to set the operating axes on the Configurator PM7.
- The home return of the virtual axis is possible only by data setting.
- If pulse input is set for the master axis, the master axis will synchronize with pulse input from an external device, such as an encoder. Therefore, the master axis cannot be stopped arbitrarily.

8.2.2 Selection of Slave Axes and Settings

■ Selection of Slave Axes

The 1st to 4th axes are available as slave axes. The virtual axis can be used only as the master axis.

When “Synchronous master axis” is selected in the synchronous parameter dialog box of the Configurator PM7, the corresponding axis will operate as a slave axis for the specified master axis.

Up to four slave axes can be set for a single master axis.

Axes set as slave axes operate in synchronization with the master axis as long as synchronous control is enabled. No slave axes can perform positioning and other control independently from the master axis while synchronous control is enabled.

■ Settings for Slave Axes

The slave axes operate in synchronization with the master axis. Set the following items, however, for each individual slave axis.

- Unit setting
- Number of pulses per rotation
- Movement amount per rotation

8.3 Start and Cancel of Synchronous Control

8.3.1 Start and Cancel of Synchronous Control

■ Start and cancel operations

- It is possible to cancel the synchronous control temporarily with a sync cancel request signal turned ON.
- It is possible to operate any slave axes individually while the synchronous state is canceled.
- The synchronous control can be started again with the sync cancel request signal turned OFF.
- The synchronous control can be cancelled while a master axis is activated. (This function is available from the unit of Ver.1.50 or later.)

■ I/O signal allocation

Signal name	1st axis	2nd axis	3rd axis	4th axis	Operation
Synchronous cancel request	Y88	Y89	Y8A	Y8B	ON: Cancel synchronous control; OFF: Execute synchronous control
Synchronous cancel alarm	X88	X89	X8A	X8B	ON: Synchronous control canceled; OFF: Under synchronous control

(Note 1): The I/O numbers in the above table show relative addresses based on the base word number. I/O numbers actually used vary with the number of the slot where the unit is installed and the first word number.

Automatic Operation (Synchronous Control)

■ Operations while synchronous control is performed/canceled

Operation request axis		Operation while synchronous control is performed		Operation while synchronous control is canceled
		Master axis set	Slave axis set	Master/Slave axis set
Home return		<p>No</p> <p>The master axis performs a home return.</p> <p>The slave axes do not perform a home return but operate in synchronization with output from the master axis.</p> <p>For performing home return, cancel the synchronous control and operate.</p>	<p>No</p> <p>The slave axes do not operate in response to operation requests.</p>	<p>Yes</p> <p>The master axis or slave axes will perform a home return only if the master axis or the slave axes are so requested.</p>
JOG operation		<p>Yes</p> <p>The slave axes operate in synchronization with the operation request of the master axis.</p>		<p>Yes</p> <p>The master axis or slave axes will go into JOG operation only if the master axis or the slave axes are so requested.</p>
Positioning	Single axis	<p>Yes</p> <p>Interpolation will be executed upon request if the master axis is the start axis of interpolation.</p> <p>The slave axes operate in synchronization with the master axis.</p>		<p>Yes</p> <p>Interpolation will be executed upon request if the requested axis is the start axis of interpolation.</p>
	Interpolation			
Stop functions	System stop	All the axes come to a stop regardless of the synchronization settings.		
	Emergency stop	<p>Yes</p> <p>The master axis comes to a stop upon request.</p> <p>The slave axes come to a stop in synchronization with the master axis.</p>	<p>Yes</p> <p>Only axes requested come to a stop.</p>	<p>Yes</p> <p>Only axes requested come to a stop.</p> <p>(All the axes in interpolation operation come to a stop.)</p>
	Deceleration stop		<p>The master axis and other slave axes set on the same master axis continue operating.</p>	
	Limit stop	<p>The master axis and all the slave axes come to a stop.</p>		<p>Only axes resulting in a limit error come to a stop.</p>
	Error stop			<p>Only axes resulting in an error come to a stop.</p>

8.3.2 Precautions When Canceling or Starting Synchronous Control

■ **Precautions when canceling synchronous control**

- The synchronous control can be canceled during the master operation, however, slave axes will stop immediately.
- It is recommended to cancel the synchronous control after stopping slave axes using the clutch function.
- When the synchronous control is canceled, relays related to the synchronous control (synchronous slave gear ratio change state notification, synchronous slave clutch connection state notification) will turn off.

■ **Conditions for starting synchronous control**

Only when the following conditions are met, the synchronous control can be started.

- Slave axes stop.
- No stop request for slave axes is generated.
- No error occurs in slave axes.

When these conditions are not met, the unit does not become the synchronous state and the synchronous control cancel active annunciation relay does not turn off. If the synchronous cancel request kept off while the conditions are not met, the synchronous control will start once the condition to start the synchronous control is met.

■ **Phase when starting synchronous control**

It is calculated from the "current value after unit conversion" of master axis and the "cam control synchronous master axis cycle" of synchronous parameter. The remainder obtained by dividing "current value after unit conversion" by "cam control synchronous master axis cycle" is used as a phase.

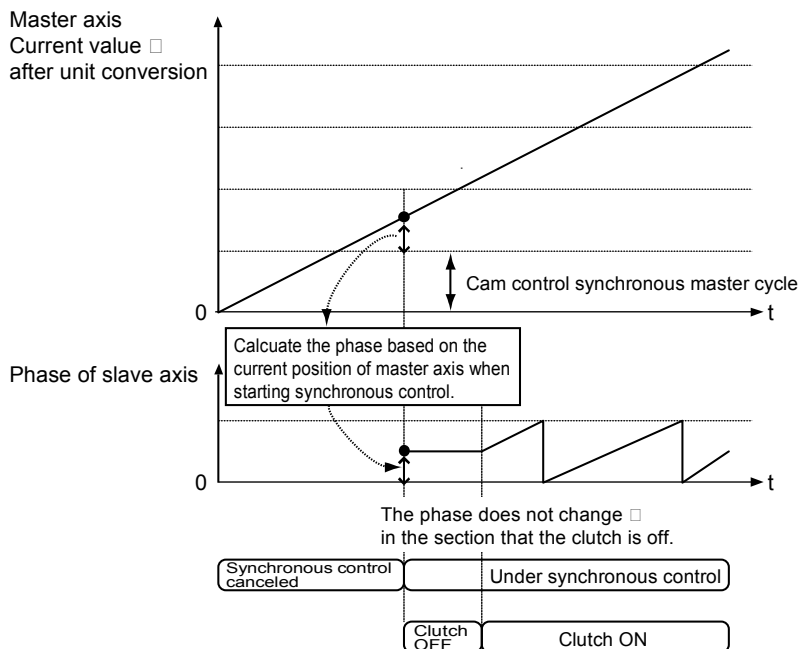

Automatic Operation (Synchronous Control)

■ Procedures of canceling and starting synchronous control

The following shows the procedures when "Level" is selected for the clutch trigger type as an example.

Section	Procedure	Operation by user programs and unit operation
Synchronous canceled	①	Turn off the synchronous slave clutch ON request by a user program.
	②	The unit turns off the synchronous slave clutch connection state annunciation.
	③	Turn on the synchronous state cancel request by a user program.
	④	The unit cancel the synchronous control when the synchronous cancel active annunciation turns on.
Synchronous started	⑤	Turn off the synchronous state cancel request by a user program.
	⑥	The unit turns off the synchronous cancel active annunciation.
	⑦	Turn on the synchronous slave clutch ON request by a user program.
	⑧	The unit starts the synchronous operation of slave axes when the synchronous slave clutch connection state annunciation turns on.

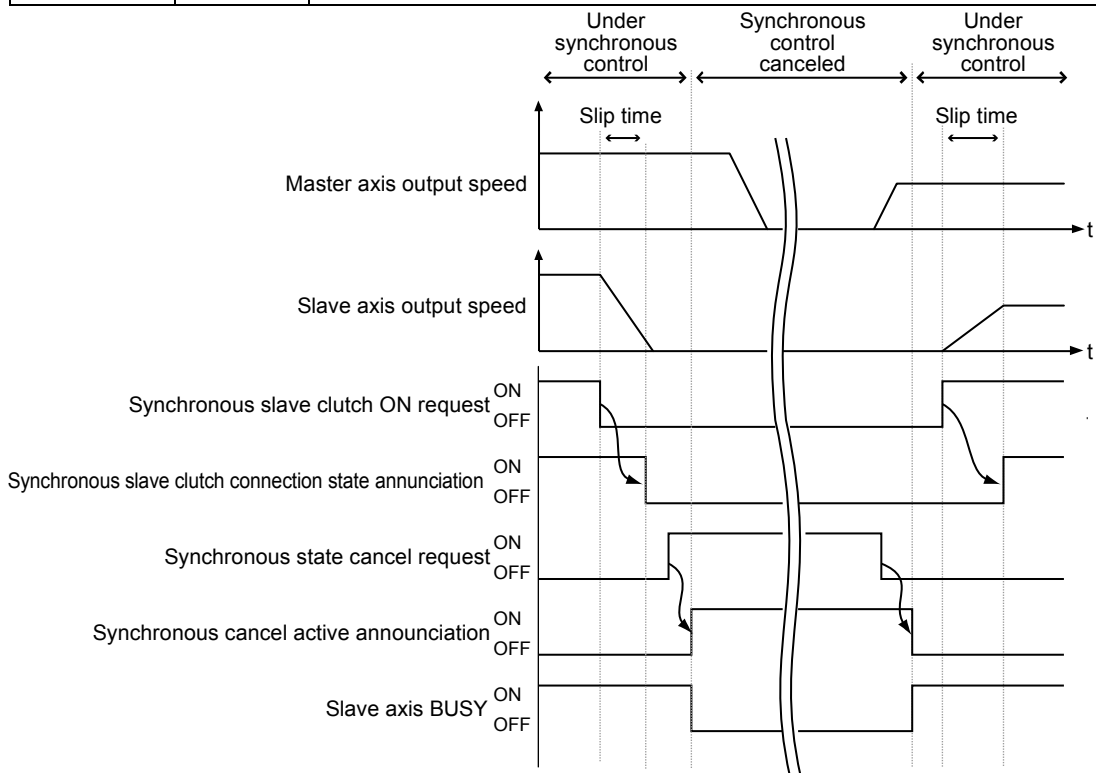

■ I/O allocation

Signal name	1st axis	2nd axis	3rd axis	4th axis
Synchronous cancel request	Y88	Y89	Y8A	Y8B
Synchronous cancel active annunciation	X88	X89	X8A	X8B
Synchronous slave clutch ON request	Y98	Y99	Y9A	Y9B
Synchronous slave clutch ON request connection state annunciation	X98	X99	X9A	X9B
Slave axis BUSY	Y18	Y19	Y1A	Y1B

(Note 1): The I/O numbers in the above table show relative addresses based on the base word number. I/O numbers actually used vary with the number of the slot where the unit is installed and the first word number.

■ Operation when selecting "Level" for the clutch ON trigger type

- If the "synchronous slave clutch ON request" is on when the synchronous control start processing is executed, the clutch is connected by the direct method regardless of the setting of "slip method".
- However, if the "synchronous slave clutch ON request" is off when the synchronous control start processing is executed, the clutch is connected according to the setting of "slip method".

When the synchronous slave clutch ON request is on when the synchronous control start processing is executed

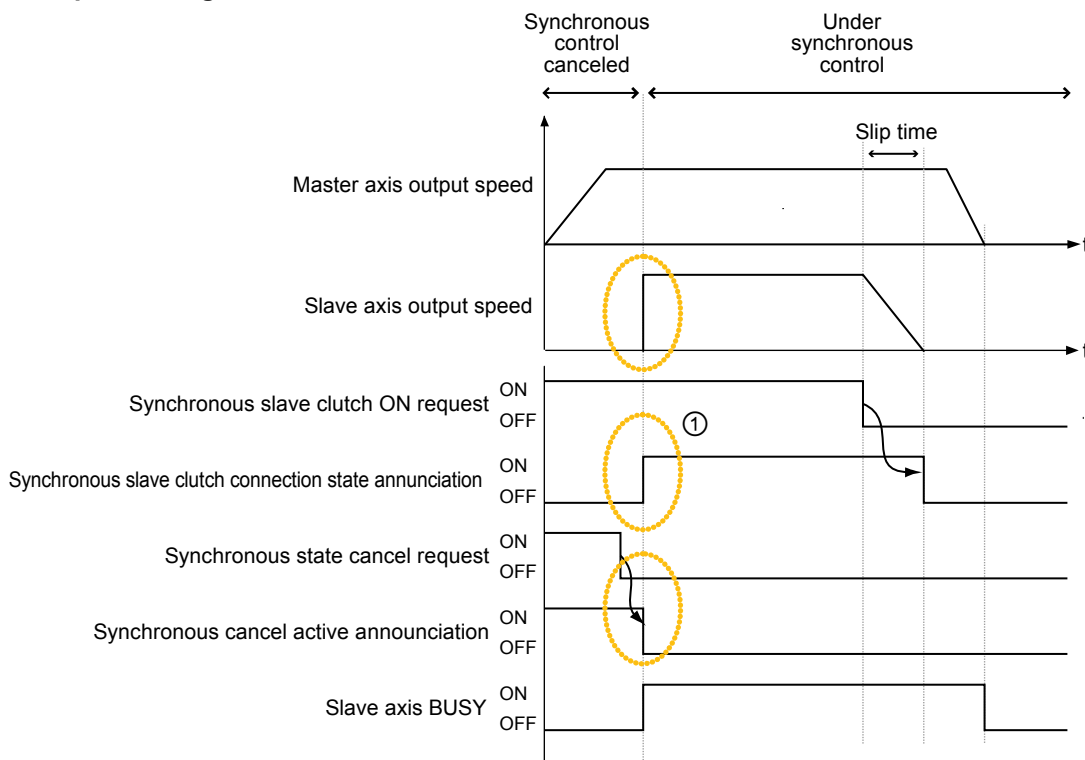

①

The slave axes start the operation immediately as the clutch is connected (synchronous slave clutch connection state annunciation: ON) when the synchronous control starts (synchronous cancel active annunciation: OFF).

Automatic Operation (Synchronous Control)

When the synchronous slave clutch ON request is off when the synchronous control start processing is executed

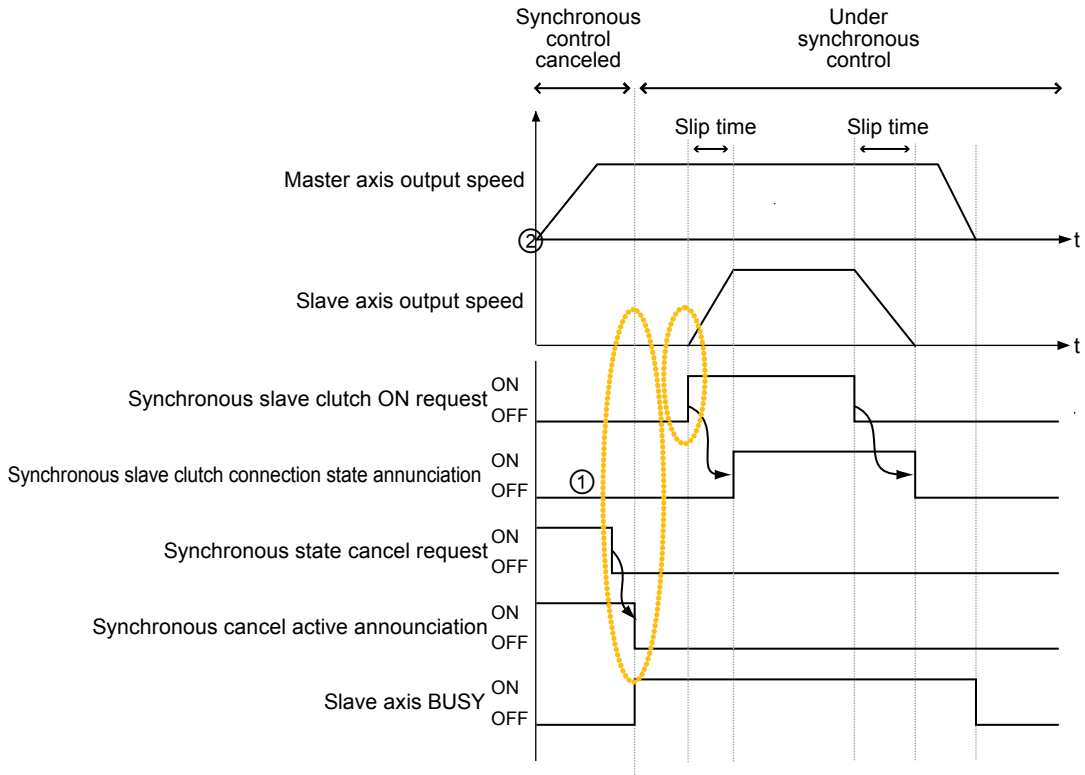

①	The slave axes do not operate immediately as the clutch is not connected (synchronous slave clutch connection state annunciation: OFF) when the synchronous control starts (synchronous cancel active annunciation: OFF).
②	Slave axes start the operation by the synchronous slave clutch ON request.

■ I/O allocation

Signal name	1st axis	2nd axis	3rd axis	4th axis
Synchronous cancel request	Y88	Y89	Y8A	Y8B
Synchronous cancel active annunciation	X88	X89	X8A	X8B
Synchronous slave clutch ON request	Y98	Y99	Y9A	Y9B
Synchronous slave clutch ON request connection state annunciation	X98	X99	X9A	X9B
Slave axis BUSY	Y18	Y19	Y1A	Y1B

(Note 1): The I/O numbers in the above table show relative addresses based on the base word number. I/O numbers actually used vary with the number of the slot where the unit is installed and the first word number.

8.4 Electronic Gear Function

8.4.1 Outline of Electronic Gear Function

■ Electronic Gear Function

The electronic gear function operates the positioning unit at the speed of the master axis multiplied by a preset gear ratio.

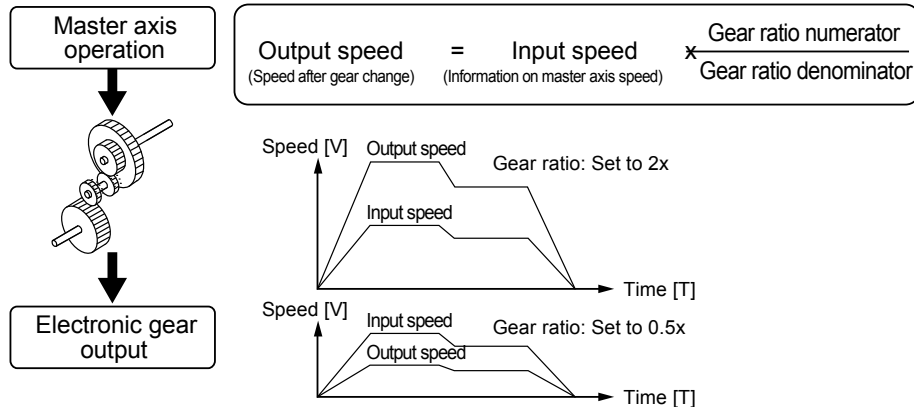

■ Cautions for using the electronic gear function.

The use of the electronic gear function makes it possible to set the slave axes to a desired speed relative to the master axis. The movement amount of the slave axes, however, is obtained from the following formula. Therefore, the movement amount of the master axis does not coincide with that of the slave axes.

Movement amount of slave axes = Movement amount of master axis x (gear ratio numerator/Gear ratio denominator)

* On the condition that the gear ratios are constant.

Do not use the electronic gear function if the movement amount of the master axis needs to coincide with that of the slave axes.



◆ NOTE

Keep in mind that the slave axes may come to a sudden stop if an emergency stop or deceleration stop is executed while making a gear ratio change.

8.4.2 Types and Contents of Setting Parameters

The use of the electronic gear requires the following parameter settings.

Parameter name	Outline
Electronic gear operation settings	Set to use or not to use the electronic gear function. The gear ratio of the electronic gear will be set to 1:1 if the electronic gear is not used, and the operation of the master axis will be input as it is into the electronic clutch.
Gear ratio numerator	Determines the gear ratio of the electronic gear. Electronic gear ratio is determined by the following formula.
Gear ratio denominator	Output speed of electronic gear = Operating speed of master axis x (Gear ratio numerator/Gear ratio denominator)
Gear ratio change time	The time required to change the current gear ratio to a new gear ratio if the new gear ratio is set for the electronic gear in operation.

8.4.3 Gear Ratio Changes while in Operation

■ Precautions for gear ratio changes while the positioning unit is in operation

- If the gear ratio is changed with a new gear ratio while the electronic gear is in operation, the new gear ratio will be effective with an elapse of a preset gear change time.
- If the gear ratio change time is 1, the gear ratio will be changed at an acceleration/deceleration time of 0.
- Acceleration or deceleration during the gear ratio change results in linear acceleration or deceleration. S-shaped acceleration or deceleration cannot be used.

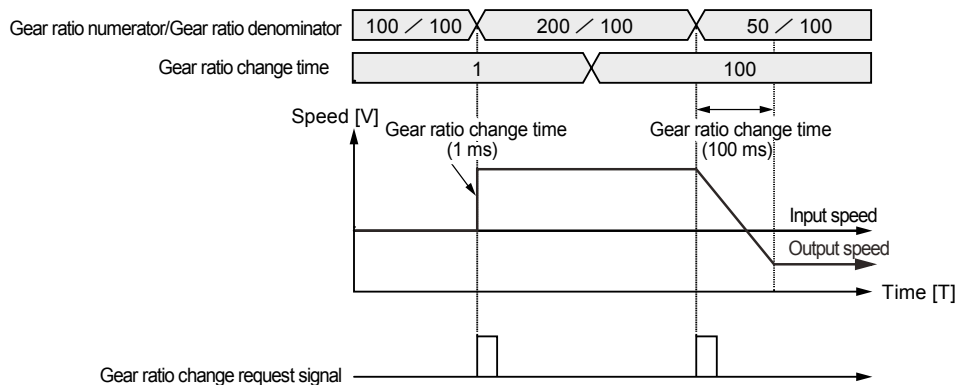

■ Programming

Follow the procedure below and write a user program in the case of changing the gear ratio while the positioning unit is in operation.

1. Change the gear ratio.

- Change the gear ratio numerator and denominator of the electronic gear in the setting area for the electronic gear.
- The gear ratio at the time of starting the positioning unit is set for this area. It is recommended to save the initial gear ratio before change so that the initial gear ratio can be reused with ease.

2. Gear ratio change request

- Turn ON an I/O signal (electronic gear ratio change request) for the target axis allocated to the unit.
- This signal enabled is of edge type. Starts the gear ratio change triggered by the gear ratio change request signal turned ON.
- Turn OFF the gear ratio change request signal after changing the gear ratio.

Automatic Operation (Synchronous Control)

■ I/O allocation

Signal name	1st axis	2nd axis	3rd axis	4th axis
Slave axis gear ratio change request	Y90	Y91	Y92	Y93
Slave axis gear ratio change request	X90	X91	X92	X93

(Note 1): The I/O numbers in the above table show relative addresses based on the base word number. I/O numbers actually used vary with the number of the slot where the unit is installed and the first word number.



◆ REFERENCE

For detailed information on the gear ratio setting area, refer to “17.7.1 Synchronous Control Setting Area”.

8.5 Electronic Clutch Function

8.5.1 Electronic Clutch Function

The electronic clutch function is used to engage or disengage the clutch for output from the electronic gear. When the electronic clutch is disengaged, the master axis will be separated from the slave axes and the slave axes not in synchronization with the master axis will come to a stop. When the electronic clutch is engaged, the master axis and slave axes will operate in synchronization.

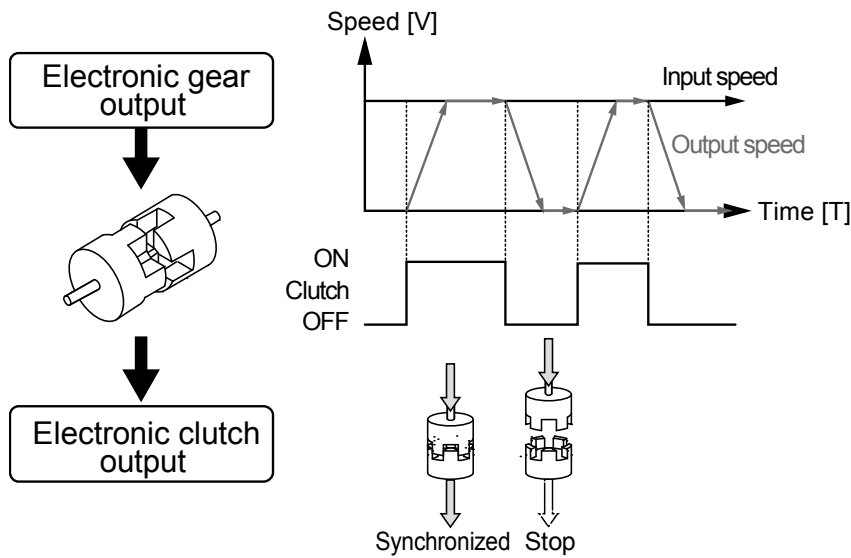

NOTE

Keep in mind that the slave axes may come to a sudden stop if the clutch is disengaged while making a gear ratio change.

8.5.2 Types and Contents of Setting Parameters

The use of the electronic clutch requires the following parameter settings.

Parameter name		Outline
Electronic clutch used/unused		<p>Set to use or not to use the electronic clutch function.</p> <p>The electronic clutch is by default disengaged.</p> <p>Be sure to engage the electronic clutch in response to the operation.</p> <p>The electronic clutch will be always engaged when the electronic clutch is not in use, in which case, output data from the electronic gear will be input as it is into the electronic cam. At that time, the master axis will always operate in synchronization with the slave axes.</p>
Clutch ON	Trigger type	Set an I/O clutch ON request as a trigger to be detected.
	Edge selection	Select the method of trigger signal detection from "Level," "Rising edge," or "Falling edge."
	Method	Select "Direct" or "Slip" for the engagement of the clutch.
	Slip time	If "Slip" is selected, set the slip time.
Clutch OFF	Trigger type	Set an I/O clutch OFF request or "I/O+Phase after clutch" as a trigger to be detected. (Note 1)
	Edge selection	Select the method of trigger signal detection from "Level," "Rising edge," or "Falling edge."
	Method	Select "Direct" or "Slip" for the engagement of the clutch.
	Slip time	If "Slip" is selected, set the slip time.

(Note 1): "I/O+Phase after clutch" is available for the unit Ver.1.40 or later. For setting this, FPWIN GR7 Ver.2.8 or later is required.



◆ KEY POINTS

- **The mode (I/O + Phase after clutch) has been added to stop the motors of slave axes at an arbitrary phase after turning off the clutch. This function is available for the unit of Ver.1.40 or later. For details, refer to "8.5.5 Phase Specification Clutch Off Function".**

8.5.3 Trigger Types for Electronic Clutch

The following methods are available for the engagement or disengagement of the electronic clutch.

■ **Clutch request signal (Y98 to Y9B and Y100 to Y103)**

An I/O signal (clutch request signal) allocated to the unit is in control of the electronic clutch.

■ **I/O allocation**

Signal type	1st axis	2nd axis	3rd axis	4th axis	Operation
Slave axis clutch ON request	Y98	Y99	Y9A	Y9B	
Slave axis clutch OFF request	Y100	Y101	Y102	Y103	
Slave axis clutch operation annunciation	X98	X99	X9A	X9B	ON: Engaged; OFF: Disengaged

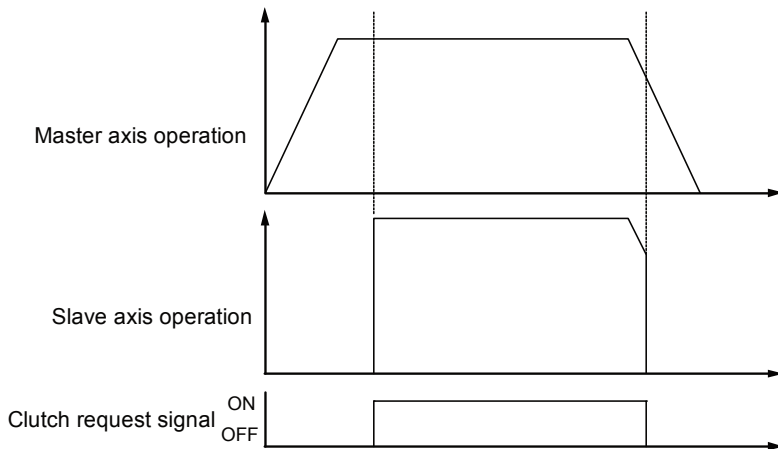

(Note): The above shows an example of the direct method selected for the engagement of the clutch.

■ **Edge selection**

Edge selection	Operation
Level	The clutch operation is switched by turning on or off the slave axis clutch ON request (Y98-Y9B). The slave axis clutch OFF request signal is not used. When the edge selection is level, the slave clutch OFF request (Y100-Y103) is invalid.
Leading edge	The clutch turns ON by the leading edge of the slave clutch ON request (Y98-Y9B). Also, the clutch turns OFF by the leading edge of the slave clutch OFF request (Y100-Y103).
Trailing edge	The clutch turns ON by the trailing edge of the slave clutch ON request (Y98-Y9B). Also, the clutch turns OFF by the trailing edge of the slave clutch OFF request (Y100-Y103).

8.5.4 Engagement Methods of Electronic Clutch

The electronic clutch function engages the clutch to start operating the slave axes and disengages the clutch to stop operating the slave axes, the acceleration or deceleration of the slave axes can be set as shown below.

■ Direct method

This method detects the engagement or disengagement of the clutch to adjust the operating speed of the master axis to coincide with that of the slave axes. In the direct method, the speed of the slave axes with the clutch engaged or disengaged coincides with the operating speed of the master axis with the acceleration and deceleration time set to 0.

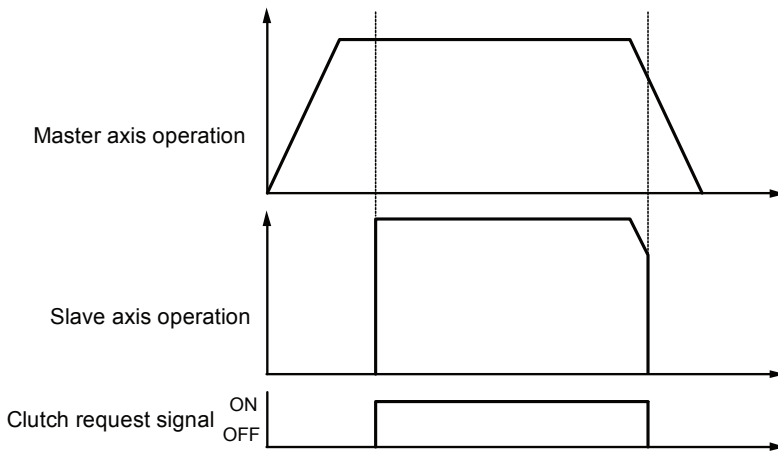

■ Slip method

This method detects the engagement or disengagement of the clutch and set the slip time to acceleration time and deceleration time so that the operating speed of the slave axes to follow speed the operation speed of the master axis. Linear acceleration and deceleration will apply.

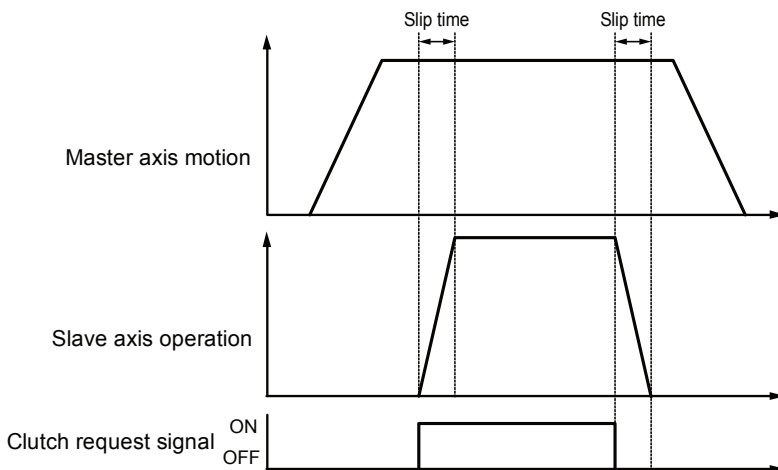

8.5.5 Phase Specification Clutch Off Function

The "phase specification clutch OFF function" is a function for turning off an electronic clutch at an arbitrarily specified phase. For stopping or starting at the same phase repeatedly, the control without variance can be performed. This function is available for the unit of Ver.1.40 or later.

■ **Phase specification clutch OFF function**

When performing the OFF request by the I/O signal, the clutch off operation will be executed regardless of phase.

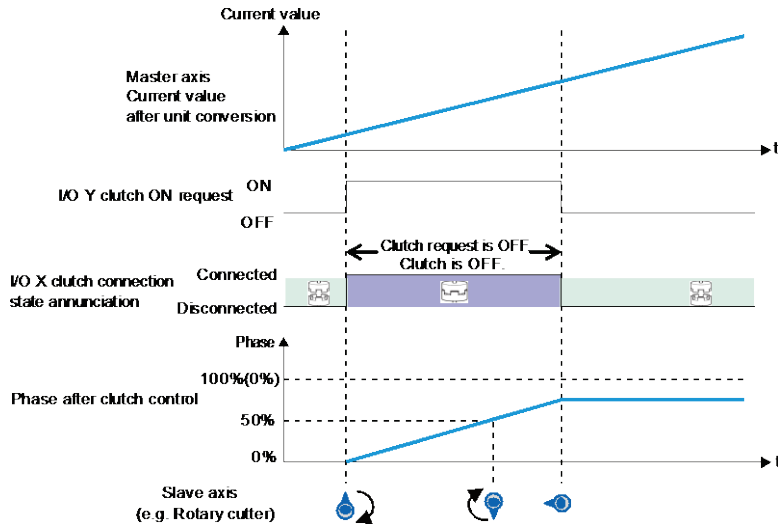

Using the "phase specification clutch off function" turns a clutch off when the phase reaches the set phase after the clutch off request by the I/O signal.

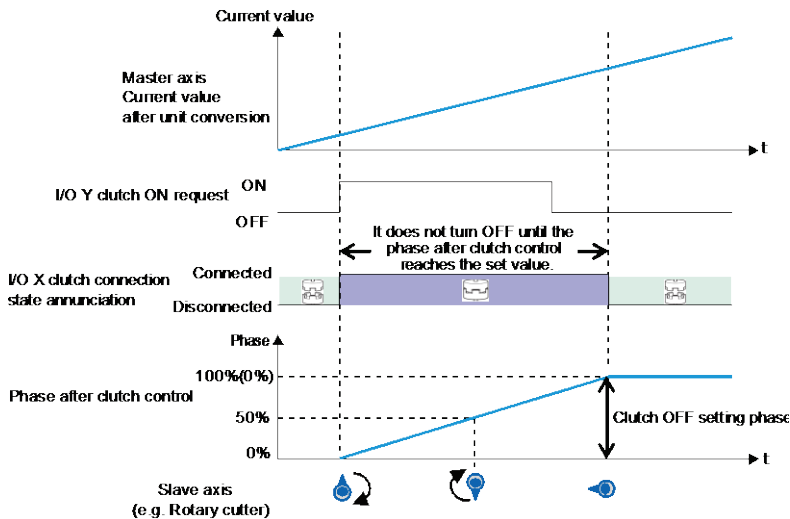

(Note 1): The above figure shows the case that the both clutch on request and off request are set to "Level". Also, either "Rising edge" or "Falling edge" can be selected.

(Note 2): The above figure shows the case that the clutch off setting ratio is set to "0%". It can be set to 0 to 99%.

■ Precautions for operation characteristics

- When setting "Slip" for the clutch off method, the deceleration stop is performed after a specified slip time from the time that the phase reaches the clutch off setting ratio. To stop the motors at the phase of a set ratio, set the clutch off method to "Direct".

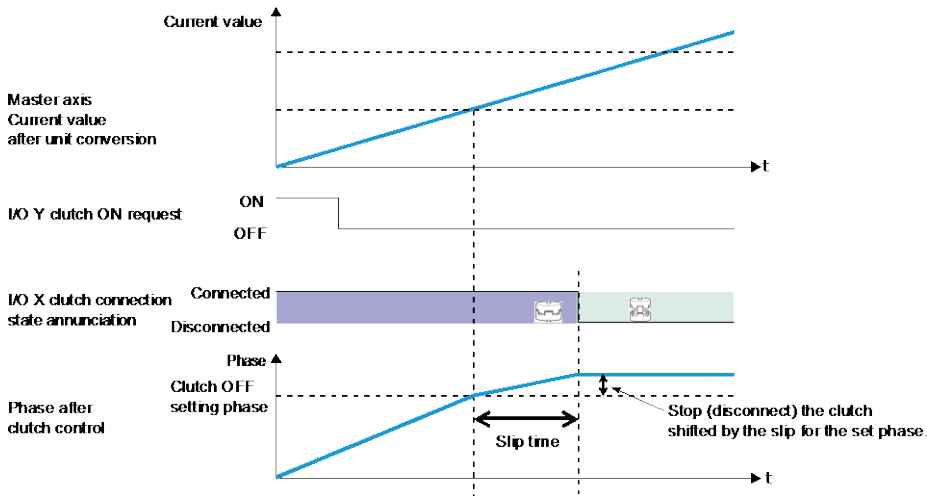

- When the clutch off trigger signal is detected at a phase larger than the set clutch off setting ratio (0 to 99%), the clutch will be off at the next time the signal reaches the set phase.

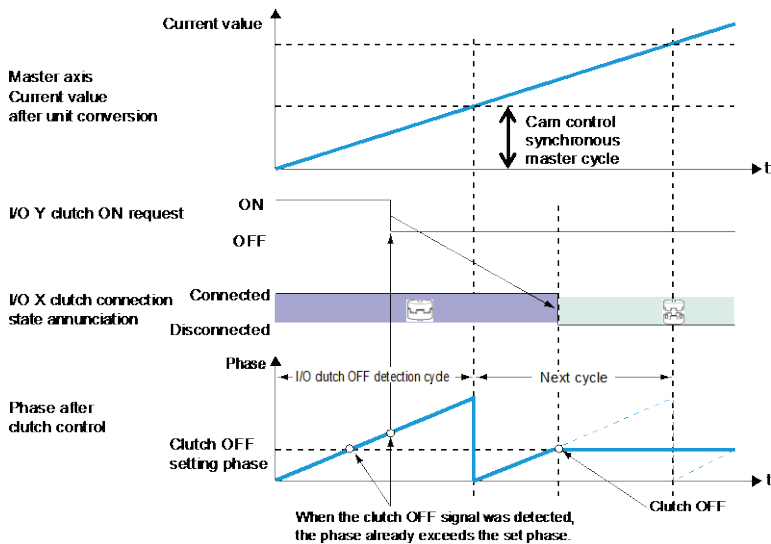

8.6 Electronic Cam Function

8.6.1 Outline of Electronic Cam Function

■ Electronic cam function

The electronic cam function uses a preset cam pattern, determines the movement amount of the slave axes according to the operation of the master axis (phase information) and cam pattern, and outputs the movement amount. The cam pattern uses one rotation of the master axis as an operation reference, based on which the displacement of the slave axes in each phase (rotation angle) is defined on the Configurator screen.

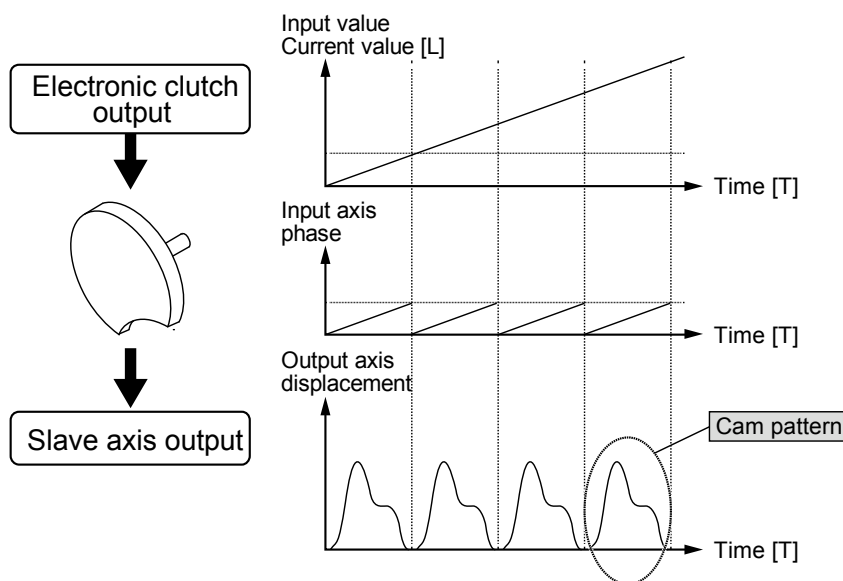

■ Cam pattern

The cam pattern uses one rotation of the master axis as an operation reference, based on which the displacement of the slave axes in each phase (rotation angle) is defined. The cam pattern is defined with the phase (rotation angle) of the master axis based on one rotation as a reference on the X-axis and the displacement on the Y-axis in percent. The cam pattern is set with the desired settings for the positioning unit selected from the FPWIN GR7 Configuration screen.

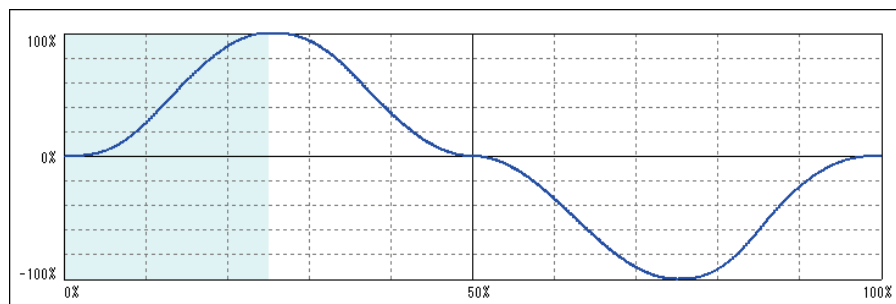

■ Cam pattern specifications

Setting items	Description
Resolution	1024, 2048, 4096, 8192, 16384, 32768
No. of cam patterns	Resolutions of 1024, 2048, 4096, and 8192: 16 Resolution of 16384: 8 Resolution of 32768: 4
Section setting	100%/cycle, 20 sections max.
Displacement setting	100% setting
Cam curve	Selected from the following ones Uniform velocity/Constant acceleration/Simple harmonic motion/Cycloid/Modified trapezoid/Modified sine/Trapezoid One-dwell cycloidal m=1/One-dwell cycloidal m=2/3/One-dwell modified trapezoid m=2/3/One-dwell modified trapezoidal (Ferguson)/One-dwell modified sine/One-dwell trapezoid/No-dwell modified trapezoid/NC2 curve/Asymmetric cycloid/Asymmetric modified trapezoid
Adjustment function	Function to adjust the displacement of desired point data. 1,000 points max. (in units of cam data)
Shift function	Phase shift in created cam data 0% to 100%
Indication	Displacement/Speed/Acceleration/Jerk A check box allows desired display.



◆ KEY POINTS

- The advance angle correction function has been added, which corrects the response delay of cam output axis. This function is available for the unit of Ver.1.5 or later. For details, refer to “8.5.5 Phase Specification Clutch Off Function“.

8.6.2 Types and Contents of Setting Parameters

The use of the electronic cam requires the following parameter settings.

Parameter name	Outline
Electronic cam use/non-use	Select the use or non-use of the electronic cam function. When the electronic cam is not used, the electronic cam function will not work, and output from the electronic clutch will be output as pulses.
Cam pattern	The cam pattern is the most fundamental setting for using the electronic cam function. The cam pattern is set in the cam pattern settings window in the FPWIN GR7 Configuration screen. The positioning unit converts cam patterns into point data based on the preset cam curves and resolutions.
Cam control master axis period	Set the number of pulses corresponding to the total phase of the cam pattern used (one-rotation data on the master axis).
Cam pattern number to use	Specify the cam pattern number to be used from cam patterns created.
Cam stroke	Set the number of pulses corresponding to the total displacement (100%) of the cam pattern to use.
Advance angle correction operation setting	Select the use or non-use of the advance angle correction function.
Reference value	The unit follows the unit system of the master axis. Setting range: -1073741823 to 1073741823 (The decimal point position is based on unit systems.)
Reference speed	The unit follows the unit system of the master axis. Setting range: 1 to 32767000 (The decimal point position is based on unit systems.)
Parameter change time	Setting range: 1 to 10000 ms

(Note 1): The advanced angle correction function is available for the unit of Ver.1.5 or later.

8.6.3 Cam Pattern Setting Method

■ Starting Cam Pattern Setting Screen

Open the Configuration screen on the FPWIN GR7 and select “Positioning settings” so that the setting tool for the positioning unit will start.

Select “Axis settings” - “Cam pattern settings” from the toolbar of the setting tool for the positioning unit or click the following icon:  The Cam Pattern Settings screen is displayed.

A blank screen will be displayed for a new file and settings for cam pattern 1 will be displayed if data already exists.

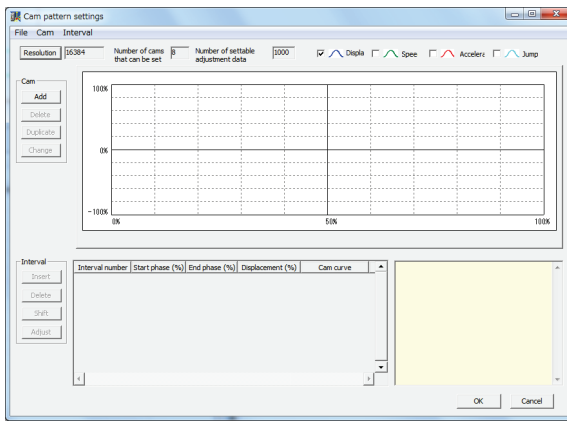

■ Resolution settings

Press the [Resolution] button on the Cam Pattern screen. The Resolution Settings screen will be displayed. Select the desired resolution and press the [OK] button.

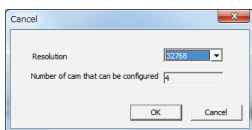

◆ KEY POINTS

- The resolution is valid for all cam patterns. You cannot set a different resolution per cam pattern.
- The number of cam patterns available varies with each resolution. The current resolution cannot be changed to a new resolution if the number of cam patterns already set exceeds the number of cam patterns available for the new resolution. Delete the cam pattern and change the resolution.

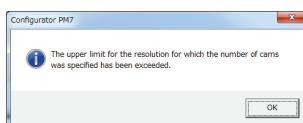

■ Making/duplicating new cam pattern

The Cam No. Selection screen is displayed by pressing the [Add] button from the Cam field.

Select the desired cam number and press the [OK] button.

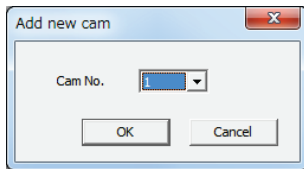

The cam pattern can be copied. Press the [Duplicate] button and select the copying destination and original cam pattern numbers.

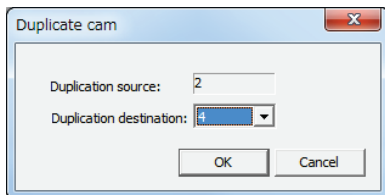

To change the cam number, press the [Change] button and select the new cam number.

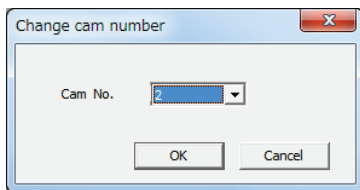

Note) The cam pattern number already set cannot be changed.

Automatic Operation (Synchronous Control)

■ Cam pattern setting

Press the [Insert] button from the Interval field. Select the desired starting phase and press the [OK] button.

The cam pattern is by default set to a single section at a phase of 0% to 100%.

The above section is divided into a number of sections by setting the starting phase.

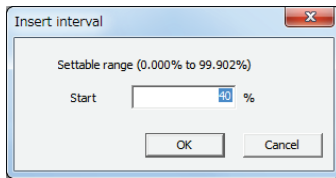

The selected sections are displayed with a white background and the non-selected sections are displayed with a gray background.

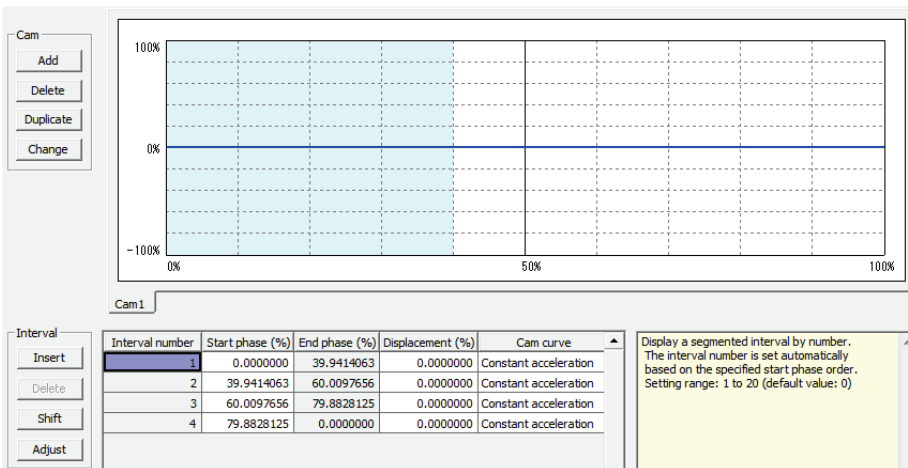

◆ NOTE

In relation to the resolution, the starting phase may not be set to the specified phase value.

■ **Editing of the cam table**

Edit the cam table data that was created.

Set the following items for each section set:

- Starting phase (%)
- Displacement (%)
- Cam curve

The cam curve changes according to the settings.

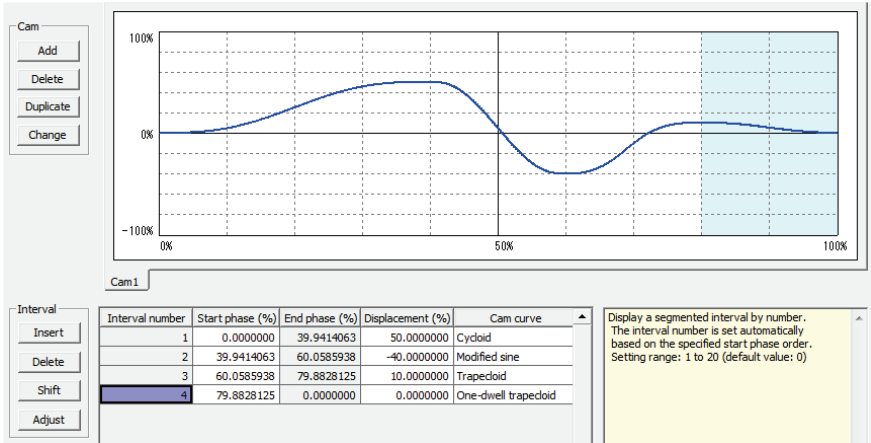

◆ **KEY POINTS**

- **The termination phase cannot be set. The termination phase will be changed automatically if the starting phase is changed.**
- **Do not make a radical displacement change of set cam curves. There is a possibility that the motor cannot keep up with the output in the case of rapid displacement.**
- **Similarly, make settings that a phase of 0% and that of 100% are the same in displacement.**

Automatic Operation (Synchronous Control)

■ Cam table checks

Check the cam table (cam curve) that has been set. The slave axes in synchronous control operate to follow the cam curve cam. Therefore, there will be a possibility that the motor cannot follow the output if the change in the cam curve is steep. In addition, it is important to know information on the acceleration as well as the displacement of the cam as factors affecting the change of the cam curve. The Cam Table Settings screen can display information on the following items besides the displacement.

Display item	Outline
Displacement	An item set on the cam table.
Speed	The operating speed of the cam table for the amount of displacement that has been set is displayed. The relative value is displayed.
Acceleration	The acceleration in each phase is displayed. Pay attention to points of significant acceleration changes, which involve radical speed changes.
Jerk	Jerk, which is obtained from acceleration differentiated by time, represents the rate of change of acceleration.

Each display item is set by checking the following boxes in the Cam Table Settings screen. Refer to each display item and make setting changes in the cam table.

Displa
 Spee
 Accelerz
 Jump

Resolution 32768
Number of cams that can be set 4
Number of settable adjustment data 1000

Cam
 Add
 Delete
 Duplicate
 Change

Interval
 Insert
 Delete
 Shift

Interval number	Start phase (%)	End phase (%)	Displacement (%)	Cam curve
1	0.0000000	39.9414063	50.0000000	Cycloid
2	39.9414063	60.0585938	-40.0000000	Modified sine
3	60.0585938	79.8828125	10.0000000	Trapezoid
4	79.8828125	0.0000000	0.0000000	One-dwell trapezoid

Display a segmented interval by number.
 The interval number is set automatically based on the specified start phase order.
 Setting range: 1 to 20 (default value: 0)

■ Cam table adjustments

The Cam Table settings screen is provided with a function to make the fine-tuning of set cam curve data. In order to mitigate radical changes, this adjustment function makes it possible to fine-tune cam data that has been set. To make adjustments, select the target section number and press the [Adjust] button. The adjustment screen is displayed. The Adjustment screen displays the tables corresponding to the numbers of the designated sections out of all the sections (0% to 100%) divided by the resolution.

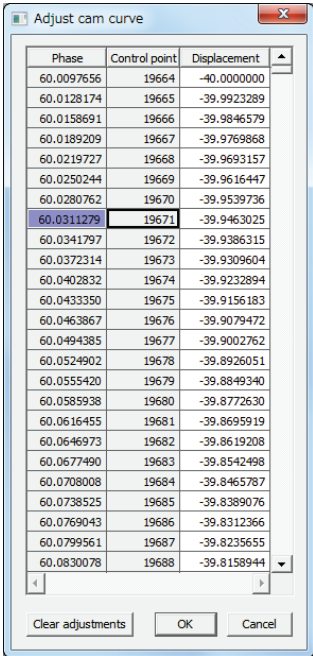

Select the data on the target phases (control points) and change the corresponding displacement data. The adjustments will be reflected by selecting [OK] and the set adjustment data will be cleared by selecting [Adjustment clear]. The numbers of the adjusted sections where the cam curve adjustments have been made are displayed in red, which tells that the adjustments have been completed.

The screenshot shows a table with five columns: "Interval number", "Start phase (%)", "End phase (%)", "Displacement (%)", and "Cam curve". The table has four rows. The third row is highlighted with a blue background. A red box highlights the "Trapezoid" entry in the "Cam curve" column of the third row. A callout box with an arrow points to this red box, containing the text "Adjusted data (displayed in red)".

Interval number	Start phase (%)	End phase (%)	Displacement (%)	Cam curve
1	0.0000000	39.9414063	50.0000000	Cycloid
2	39.9414063	60.0097656	-40.0000000	Modified sine
3	60.0097656	79.8828125	10.0000000	Trapezoid
4	79.8828125	0.0000000	0.0000000	One-dwell trapezoid

■ Cam table shift

The created cam pattern is defined with a phase of 0% to 100%, but the actual operation may differ in phase from the reference of the cam pattern. The cam table shift is a function to set the percentage of the created cam pattern for the phase at a current coordinate position of zero.

Shift image of electronic cam

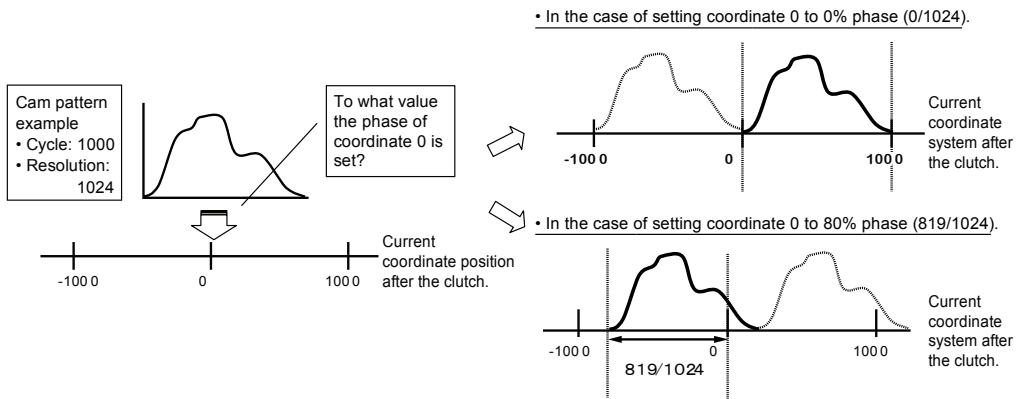

Select the shift from "Interval" and set the shift amount.

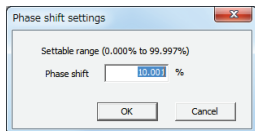

The created cam pattern is shifted 10% and the display is updated.

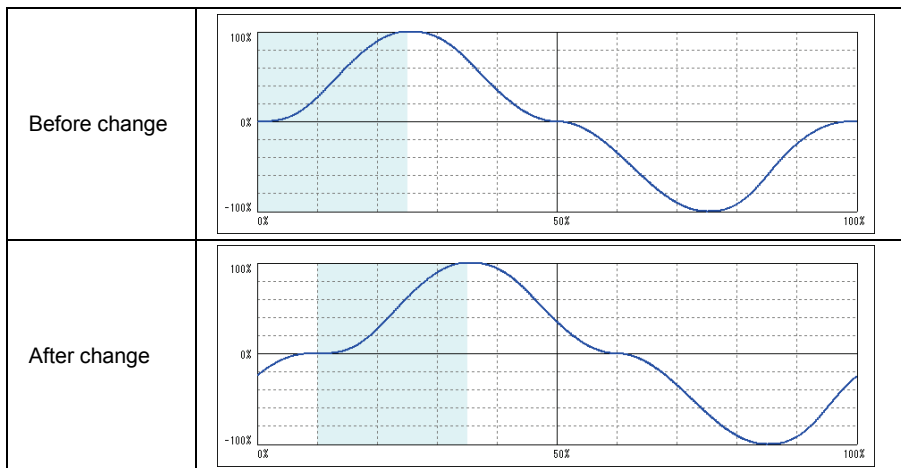

■ Storage of cam tables

Created cam tables can be automatically saved by pressing the [OK] button on the cam table setting screen. Saved cam tables are managed by FPWIN GR7, and set by downloading to control units.

8.6.4 Editing Cam Patterns by User Programs

Cam patterns can also be edited by user programs. This function is available for the unit of Ver.1.50 or later.

■ Procedure of editing cam patterns

The edit of cam patterns is executed by two operations, which are "Reading cam tables" and "Rewriting cam tables". These operations are performed using the "cam pattern editing area" (UM18000 to UM1805F) of unit memories, reading request contact (Y2) and rewriting request contact (Y3).

(1) Procedure of changing a cam patter that has been set

- ① Read a cam table to the cam pattern editing area (UM) by the reading request contact (Y2).
- ② Change the parameter of the cam table read to the cam pattern editing area (UM).
- ③ Execute rewriting the cam table by the rewriting request contact (Y3).

(2) Procedure of creating a new cam pattern

- ① Write parameters of created cam pattern data to the cam pattern editing area (UM).
- ② Execute rewriting the cam pattern data by the rewriting request contact (Y3).

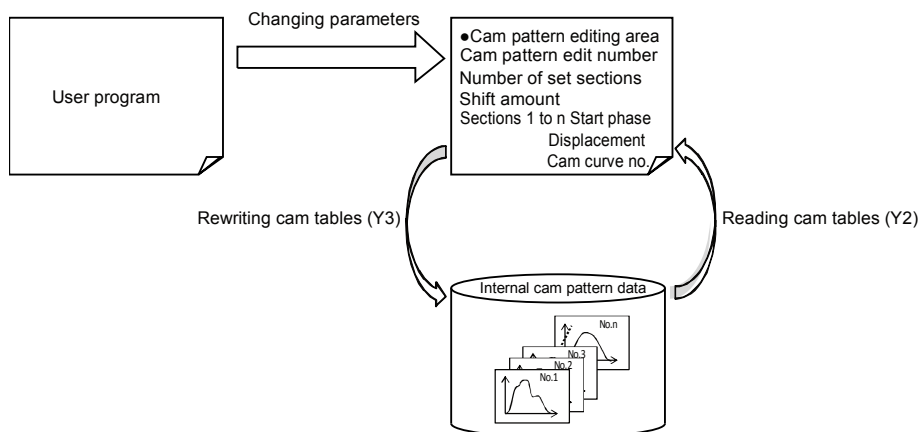

■ Execution conditions of editing cam patterns

The editing of cam patterns by programs can be executed when the following three conditions are met.

- All axes are not in synchronous operation. (The synchronous control cancel annunciation flags of all axes are ON.)
- All axes are not activated. (The busy flags of all axes are ON.)
- Parameters are set correctly.

Also, when request for reading and rewriting are executed simultaneously, reading takes priority. In this case, the execution of the rewriting request results in the abnormal end, and the response code (FF21H) is stored in the unit memory (UM18059).

Automatic Operation (Synchronous Control)

■ Procedure of reading cam pattern data

Procedure	Operation by user programs and unit operation
①	Set a cam pattern number to be read out to the cam pattern editing area (UM18000).
②	Turn on the cam table reading request (Y2).
③	On the completion of reading, a response code is stored in the cam pattern editing area (UM18058), and the cam pattern reading completion annunciation flag (X2) turns on.
④	Once the cam table reading request (Y2) turns off, the cam pattern reading completion annunciation flag (X2) turns off..

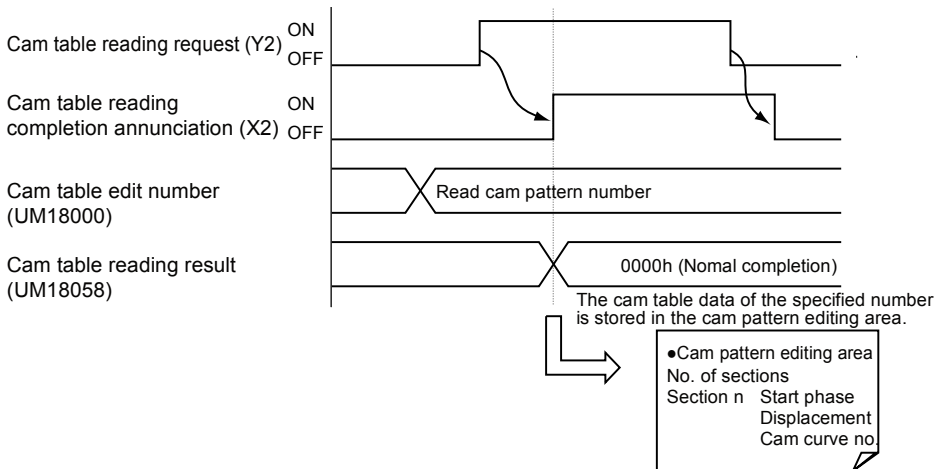

■ Related positioning parameter (Cam pattern editing area)

Unit memory No. (Hex)	Name	Default	Description
UM18058	Cam pattern reading result	H0	<ul style="list-style-type: none"> Stores the result of reading processing (response code). [Range] (Hexadecimal) 0000H: Normal end Other than 0000H: Abnormal end

■ Procedure of rewriting cam pattern data

Procedure	Operation by user programs and unit operation
①	Store necessary setting parameters in the cam pattern editing area (UM18000 to UM1805F). <ul style="list-style-type: none"> ● Rewriting cam pattern number ● No. of sections: following parameters in sections 1 to n (n is a specified number of sections.) ● Start phase ● Displacement ● Cam curve number
②	Turn on the cam table rewriting request (Y3).
③	On the completion of rewriting, a response code is stored in the cam pattern editing area (UM18059), and the cam pattern rewriting completion annunciation flag (X3) turns on.
④	Once the cam table rewriting request (Y3) turns off, the cam pattern rewriting completion annunciation flag (X3) turns off.

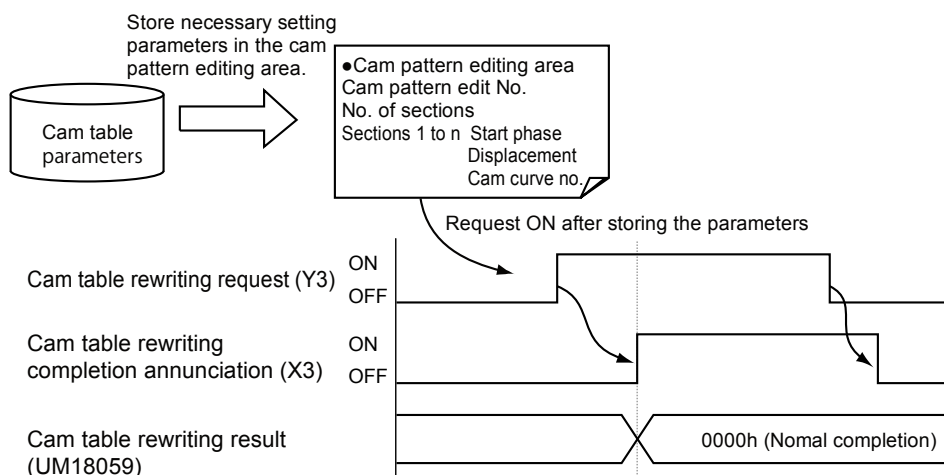

■ Related positioning parameter (Cam pattern editing area)

Unit memory No. (Hex)	Name	Default	Description
UM18059	Cam pattern rewriting result	H0	<ul style="list-style-type: none"> • Stores the result of rewriting processing (response code). [Range] (Hexadecimal) 0000H: Normal end Other than 0000H: Abnormal end



◆ REFERENCE

For details of related unit memories, refer to "17.9 Cam Pattern Editing Area".

Automatic Operation (Synchronous Control)

■ Sample program

- The following program shows the case that the phase, displacement, and the type of curve is changed in the section 2 of the cam table number 2. .
- The program is executed through five steps of (a) to (e).
- In this sample program, the positioning unit is installed in the slot number 1, and the starting word number is 10.

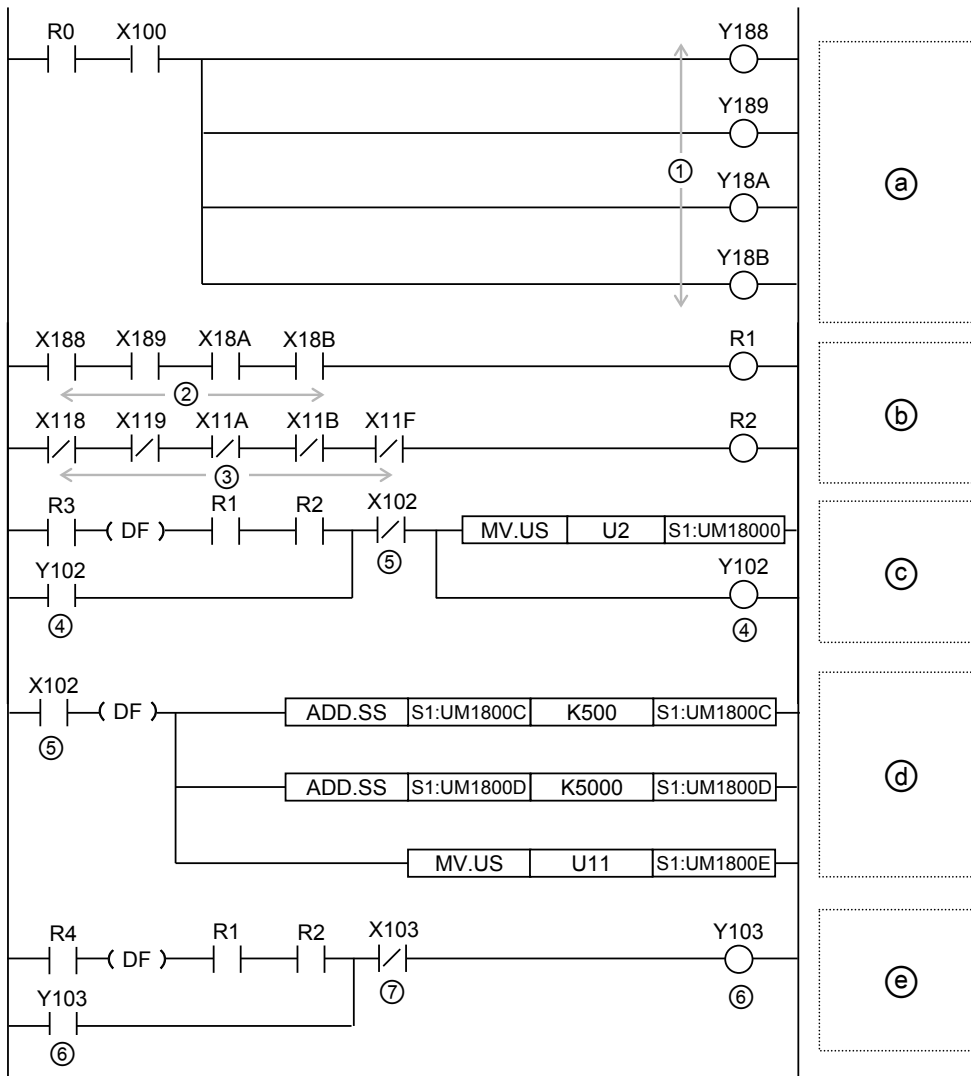

Mark	Content specified by program	Description
Ⓐ	Cancelling the synchronous control for all axes.	Performs the cancellation of synchronous control for all axes.
Ⓑ	Confirming the condition for execution permission.	Confirms that all axes are not in the synchronous control and are stopped.
Ⓒ	Starting the reading of cam tables.	Specifies a cam pattern number, and performs a reading request (Y102).
Ⓓ	Changing parameters in the cam table editing area.	Edits the cam table data in the section 3 after the completion of rading the cam table. In this example, the following three items are set. <ul style="list-style-type: none"> ● Start phase: (Value before rewriting) + Addition of 5% ● Displacement: (Value before rewriting) + Addition of 50% ● Cam curve: Constant acceleration
Ⓔ	Starting the rewriting of cam tables.	Performs the rewriting to a specified cam pattern data.

Mark	Content specified by program	Value specified in program				
		1st axis	2nd axis	3rd axis	4th axis	Virtual axis
①	Synchronous cancel request	Y188	Y189	Y18A	Y18B	-
②	Synchronous control cancellation annunciation	X188	X189	X18A	X18B	-
③	BUSY	X118	X119	X11A	X11B	X11F
④	Cam table reading request	Y102				
⑤	Cam table reading completion	X102				
⑥	Cam table rewriting request	Y103				
⑦	Cam table rewriting completion	X103				

(Note 1):I/O numbers vary according to the value of the "Starting word number" allocated to the unit. The I/O numbers in the above table are considered as the starting word number is 10.

■ Precautions for editing cam patterns by program

- Even if cam pattern data is rewritten by this function, the cam pattern data stored as the configuration data in the CPU unit will not be updated.
- It will be rewritten to a cam pattern set on Configurator PM7 when the power turns on or configuration data is rewritten and the PROG mode changes to RUN mode. As necessary, execute the rewriting of the cam pattern again by a program.
- It is possible to confirm whether the cam pattern has been rewritten or not by the cam pattern update flag (UM1805A) in the unit memory using a program.
- When performing a reading request specifying an unregistered cam pattern number, all the read data will be "0".
- When performing a rewriting request while no cam pattern is registered (a resolution is undetermined), rewriting will be performed considering the resolution as 1024.
- Cam adjustment data set on Configurator PM7 cannot be used. Also, when executing the rewriting, the adjustment data before the execution of rewriting will be initialized.



◆ REFERENCE

For details of "cam pattern update flag", refer to "17.9 Cam Pattern Editing Area".

■ Precautions when using phase shift amount

- Specify the values when the phase shift amount is 0(%) for the parameter values of cam pattern (starting phase, displacement and cam curve).
- The starting phase of the section number 1 is 0(%). When any values other than 0(%), an error will occur. For starting phases after the section number 2, specify arbitrary starting phases. When reading and writing settings, the closest phase will be automatically calculated within the unit from the resolution.
- After setting the cam pattern when the phase shift amount is 0(%), set a phase shift amount. When reading and writing settings, the closest phase amount will be automatically calculated within the unit from the resolution.

For rewriting the cam pattern set on the tool software Configurator PM7 to a user program, perform the following procedure.

- ① Record the phase shift amount specified on Configurator PM7.
- ② The phase shift amount has been added to the starting phase displayed on Configurator PM7. Set the phase shift amount to 0(%) to confirm the parameter values of cam pattern (starting phase, displacement, cam curve).
- ③ Use the parameter values acquired in ② on user programs. As for the starting phase, use values to two decimal places.
- ④ Set the phase shift amount recorded in ①. As well as the starting phase, use values to two decimal places.

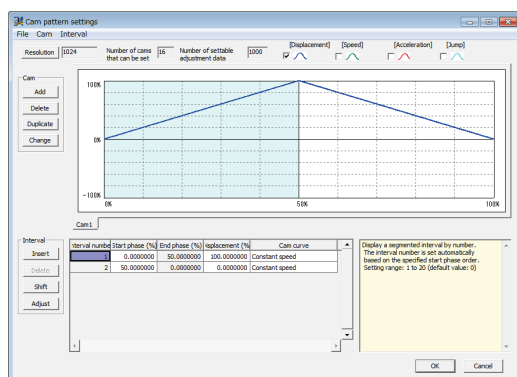
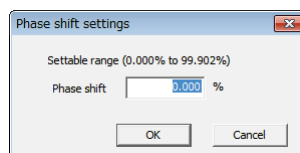
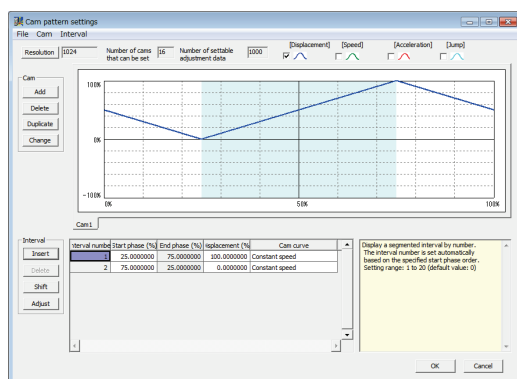

8.6.5 Advance Angle Correction Function

"Advance angle correction function" is a function to correct the delay in the response of a machine system connected to an electronic cam output or the delay in a PLC arithmetic processing time. This function is available for the unit of Ver.1.5 or later.

■ Specification of advance angle correction amount

- Advance angle correction amounts are specified for each slave axis using a tool software or user program.
- By setting "advance angle correction reference speed" and "advance angle correction reference amount", a correction amount is automatically calculated using an active "master axis input speed". The advance angle correction amount is calculated by the following formula.

$$\text{Advance angle correction amount} = \text{Master axis input speed} \times \frac{\text{Advance angle correction reference amount}}{\text{Advance angle correction reference speed}}$$

Master axis input speed: Speed information after clutch control

■ Internal processing of advance angle correction

The phase of the master axis which will be a reference of slave axis correction is obtained as operation data for according to the set values of advance angle amount. A correction amount for each slave axis is calculated based on this value as a reference.

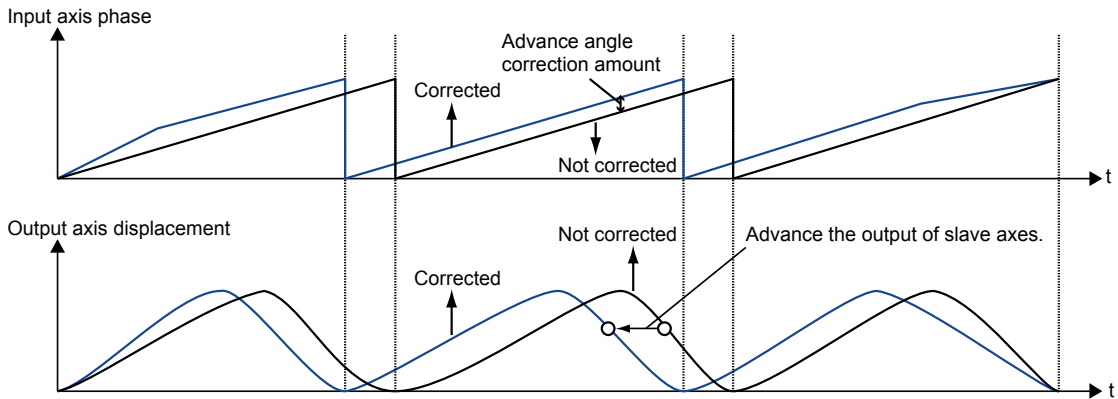

➡ To the next page

■ Setting with tool software

Set in the synchronous control setting dialog box.

Electronic cam operation settings	Use
Cam control synchronization master period	1
Cam pattern number to use	1
Cam stroke	1
Advance angle correction operation setting	Use
Reference value	0
Reference speed	100
Parameter change time	100

Parameter name	Overview
Advance angle correction operation setting	Select the use or non-use of the advance angle correction function.
Reference amount	The unit follows the unit system of the master axis. Setting range: -1073741823 to 1073741823 (The decimal point position is based on unit systems.)
Reference speed	The unit follows the unit system of the master axis. Setting range: 1 to 32767000 (The decimal point position is based on unit systems.)
Parameter change time	Setting range: 1 to 10000 ms

(Note 1): The advanced angle correction function is available for the unit of Ver.1.5 or later.

■ Setting with user programs

The following examples shows the case that the advance angle correction reference value of 1st axis is changed to 50 and the advance angle correction reference speed to 3000.

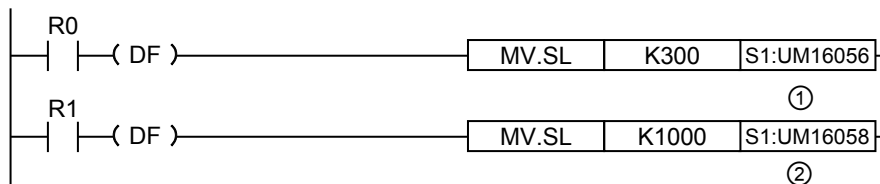

Mark	Content specified by program	Value specified by program			
		1st axis	2nd axis	3rd axis	4th axis
①	Advance angle correction reference amount setting area	UM16056	UM160C6	UM16136	UM161A6
②	Advance angle correction speed setting area	UM16058	UM160C8	UM16138	UM161A8

■ Changing the advance angle correction amount during operation

- The advance angle correction amount can be changed during operation.
- After the detection of the change in "advance angle correction reference speed" or "advance angle correction reference amount" by the unit, the advance angle correction amount will be reflected after the elapse of a specified "advance angle correction change time".

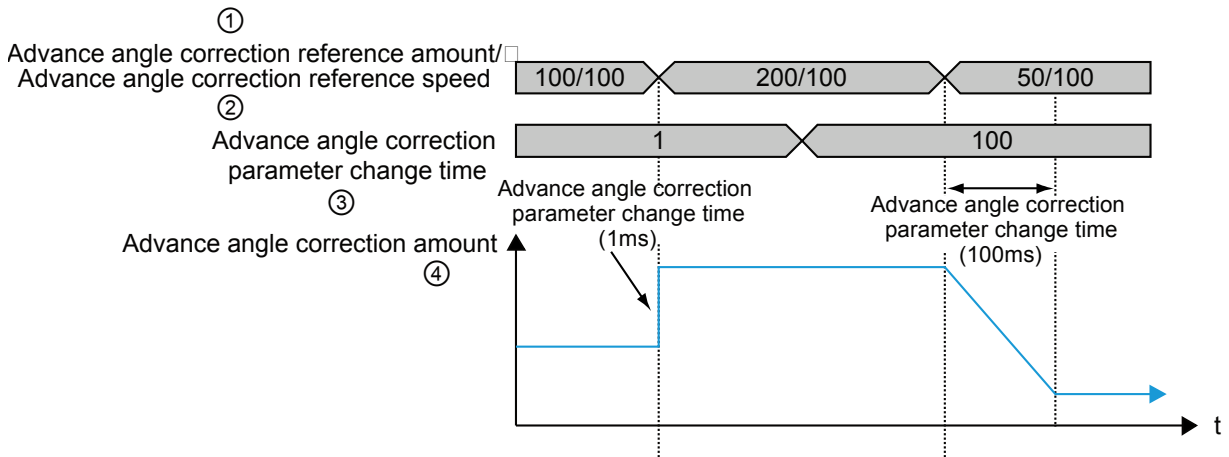

Mark	Content specified by program	Value specified by program			
		1st axis	2nd axis	3rd axis	4th axis
①	Advance angle correction reference amount setting area	UM16056 UM16057	UM160C6 UM160C7	UM16136 UM16137	UM161A6 UM161A7
②	Advance angle correction speed setting area	UM16058 UM16059	UM160C8 UM160C9	UM16138 UM16139	UM161A8 UM161A9
③	Advance angle correction parameter change time	UM1605A	UM160CA	UM1613A	UM161AA
④	Advance angle correction amount	UM00424 UM00425	UM00464 UM00465	UM004A4 UM004A5	UM004E4 UM004E5



◆ NOTES

- "Advance angle correction reference speed" and "Advance angle correction reference amount" are signed 32-bit data. If they are changed by 16-bit (1-word) unit, they may be changed to unintended values. Always perform the rewriting by 32-bit (2-word) unit.
- When changing an "advance angle correction reference speed" or "advance angle correction reference amount" during operation, the timing that the unit acquires the changed "advance angle correction reference speed" or "advance angle correction reference amount" may deviates. Change either parameter of "advance angle correction reference speed" or "advance angle correction reference amount" to prevent the "advance angle correction amount" from being rapidly changed.

■ Precautions for settings

- Overshoot or undershoot may occur according to settings when sufficient acceleration/deceleration time is not set for the start or stop of master axis while the advance angle correction function is used, or when an input speed is rapidly accelerated or decelerated by the direct connection or disconnection of a clutch while the master axis is operated.
- When using the advance angle correction function, set a sufficient acceleration/deceleration time on the master axis. When using the clutch function in combination, make the setting to prevent the occurrence of a rapid acceleration or deceleration using the slip function.

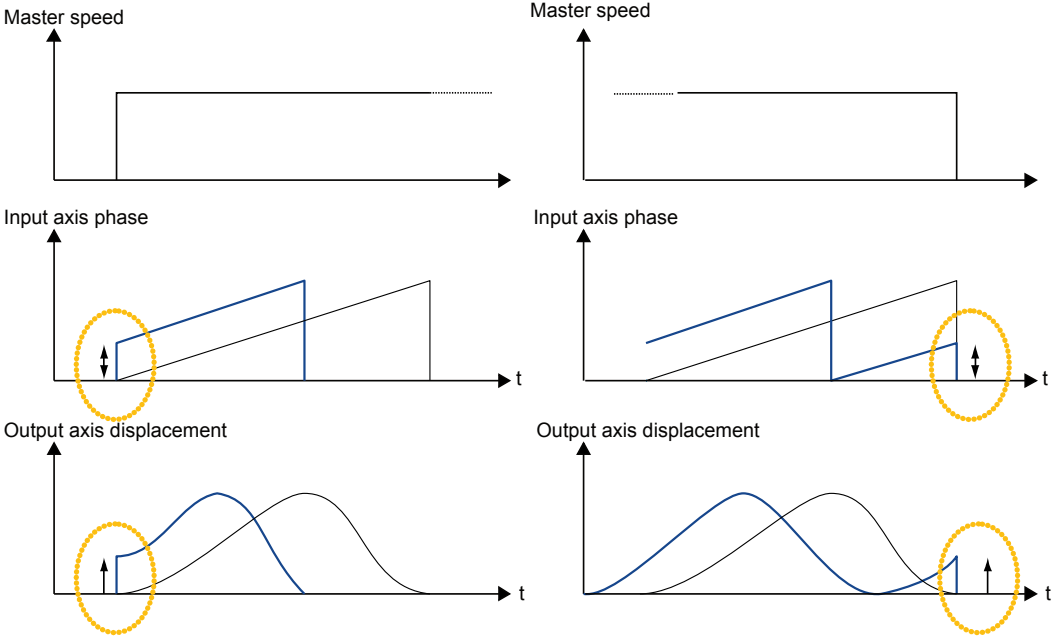

- Depending on the setting of "advance angle correction reference speed" or "advance angle correction reference amount", a calculated advance angle correction amount may exceed the "cam control synchronous master axis cycle". When the advance angle correction amount exceeds the "cam control synchronous master axis cycle", the "synchronous cam master axis cycle" will be the upper limit as below. Set the parameter of advance angle correction which meets an input speed.

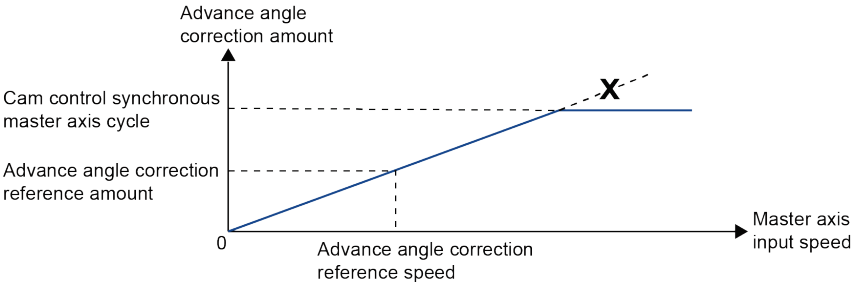

9

Manual Operation (JOG Operation)

9.1 Setting and Operation of JOG Operation

The example below is a case of the positioning unit installed in the slot 1. Settings are made in pulses.

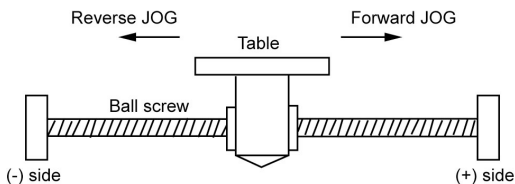

■ Settings

Parameters required for the JOG operation of the positioning unit is set in the positioning setting menu of the programming tool.

Items	Setting example
Acceleration/deceleration pattern	0: Linear acceleration/deceleration
Acceleration time (ms)	100 ms
Deceleration time (ms)	100 ms
Target speed	10000 pps

■ Operation diagram

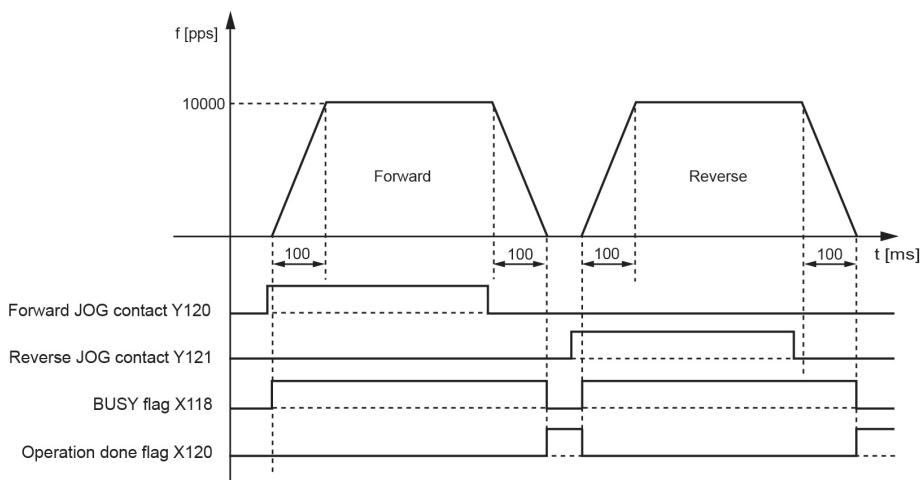

■ Operation of each contact

- The BUSY flag (X118), which indicates that the motor is running, will turn ON when the positioning control starts, and it will turn OFF when the operation completes.
- The operation done flag (X120), which indicates the completion of operation, will turn ON when the current operation is completed, and it will be held until the next positioning control, JOG operation, home return, or pulser operation starts.

■ Sample program

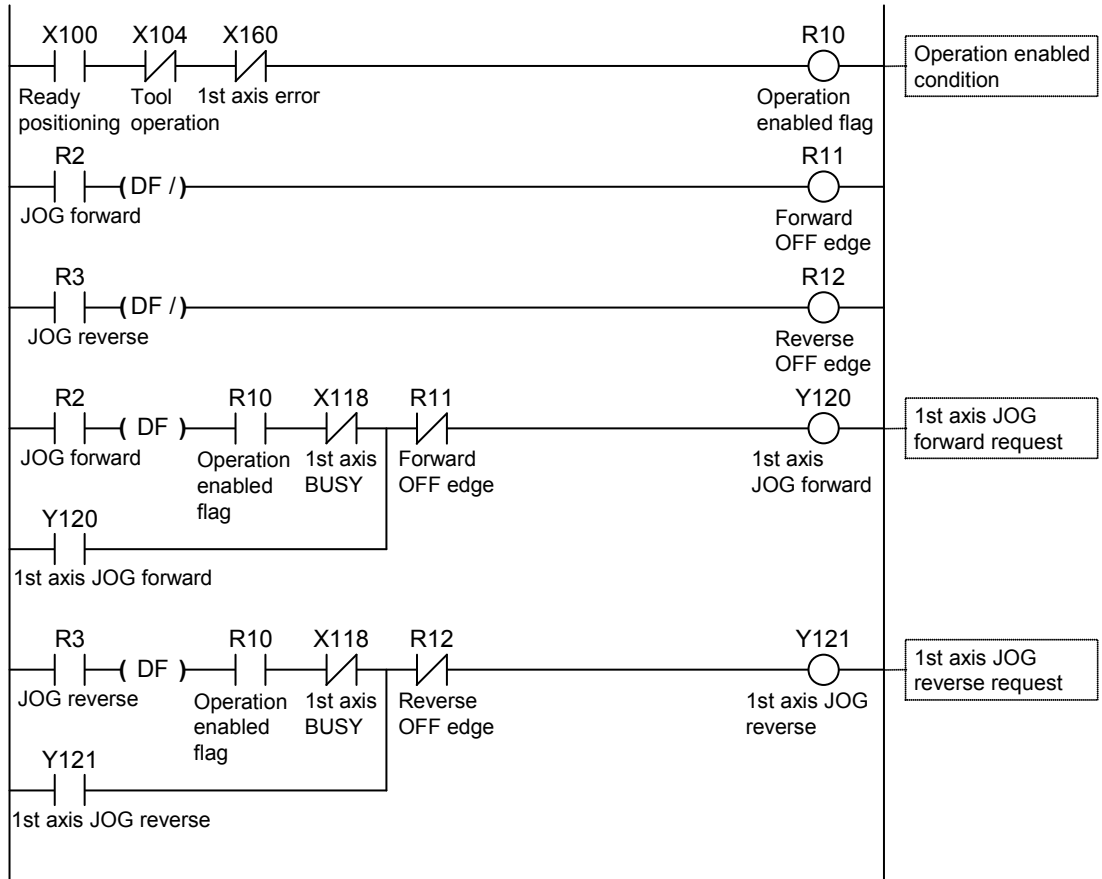

■ Programming Precautions

- The start contact and flag number varies depending on the number of axes and the installation position of the unit.
- The specified slot number varies depending on the installation position of the unit.

■ Operation at limit input

Condition	Direction	Limit status	Operation
When JOG operation is executed	Forward rotation	Limit input (+):ON	Not executable, Error occurs.
		Limit input (-):ON	Executable
	Reverse rotation	Limit input (+):ON	Executable
		Limit input (-):ON	Not executable, Error occurs.
During JOG operation	Forward rotation	Limit input (+):ON	Deceleration stop, Error occurs.
	Reverse rotation	Limit input (-):ON	Deceleration stop, Error occurs.

9.2 Changing the Speed During JOG Operation

The target speed can be changed while the positioning unit is in JOG operation.

■ Settings

Parameters required for the JOG operation of the positioning unit is set in the positioning setting menu of the programming tool.

Items	Setting example	
Acceleration/deceleration pattern	0: Linear acceleration/deceleration	
Acceleration time 1 (ms)	100 ms	
Deceleration time 1 (ms)	50 ms	
Target speed 1	10000 pps	
Acceleration time 2 (ms)	200 ms	The set values of acceleration time, deceleration time, and target speed after the speed change are written to the unit memory by the program.
Deceleration time 2 (ms)	150 ms	
Target speed 2	20000 pps	

■ Operation diagram

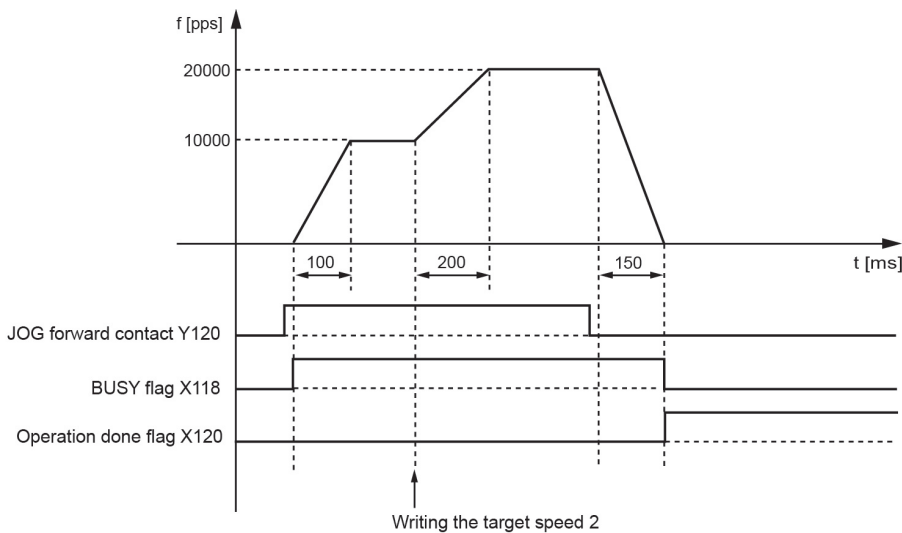

■ Operation of each contact

- The BUSY flag (X118), which indicates that the motor is running, will turn ON when the Jog operation starts, and it will turn OFF when the operation completes.
- The target speed can be changed freely while the positioning unit is in JOG operation. Use a program to change the target speed.
- The operation done flag (X120), which indicates the completion of operation, will turn ON when the current operation is completed, and it will be held until the next positioning control, JOG operation, home return, or pulser operation starts.

■ Sample program

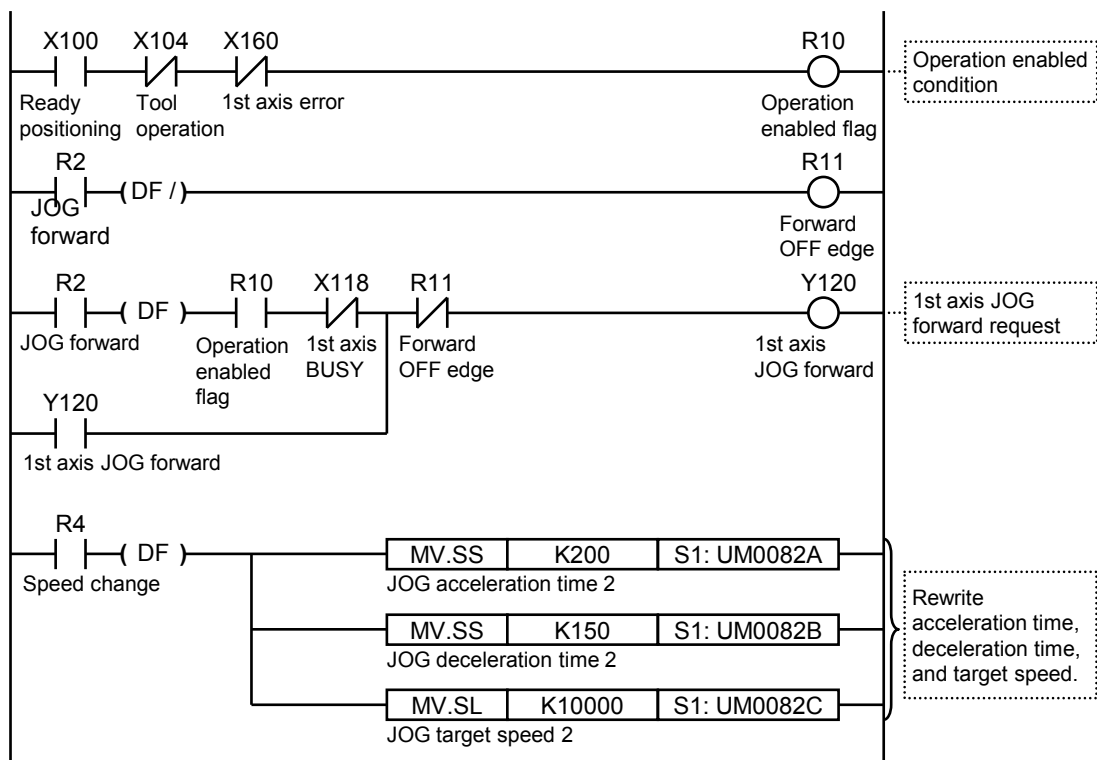

■ Programming Precautions

- To change the JOG operation speed, use a user program and rewrite the unit memory (UM0082A to UM0082C).
- The start contact and flag number varies depending on the number of axes and the installation position of the unit.
- The specified slot number varies depending on the installation position of the unit.

10

Manual Operation (Home Return)

10.1 Pattern of Home Return

The home return is a function to move the current position to the reference origin and set the coordinates as 0.

The following home return methods are available for the positioning unit.

■ DOG method 1 (Edge detection of near home switch + First rising edge of home position as reference)

The first rising edge of home position switch is detected after detecting the rising edge of the near home switch. It becomes the start point.

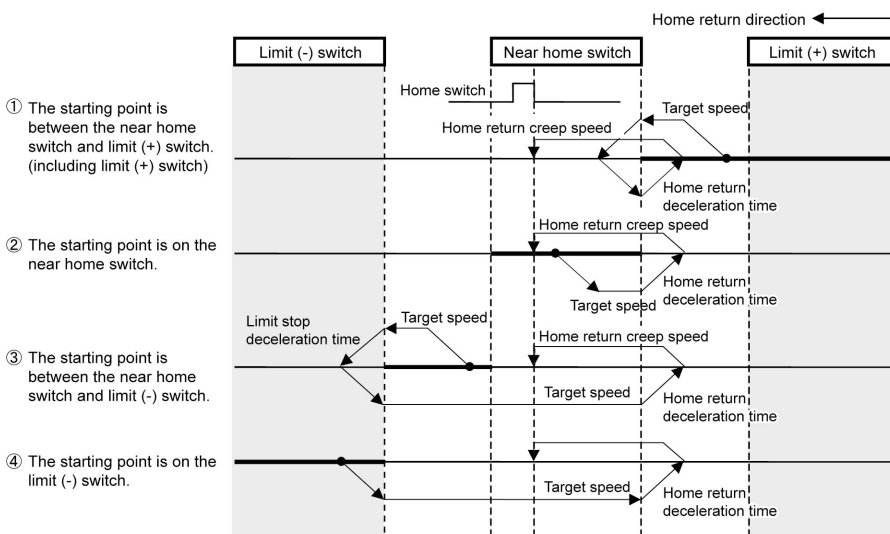

Note) When the home sensor is ON at startup, the operation is similar to ②.

■ DOG method 2 (Edge detection of near home switch)

The rising edge of the near home switch is detected. It becomes the start point.

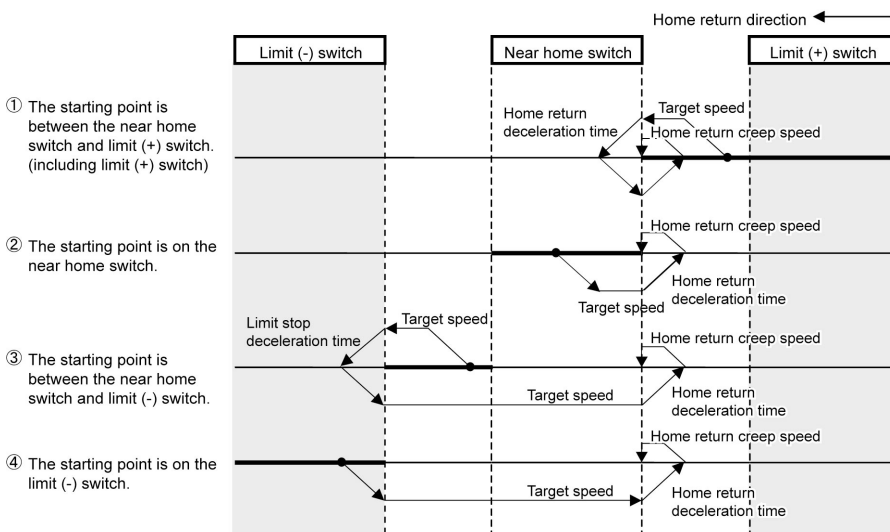

■ **DOG method 3 (Edge detection of near home switch + Falling edge of home position as reference)**

The falling edge of the near home switch is detected. The first rising edge of the home switch in the home return direction becomes the start point.

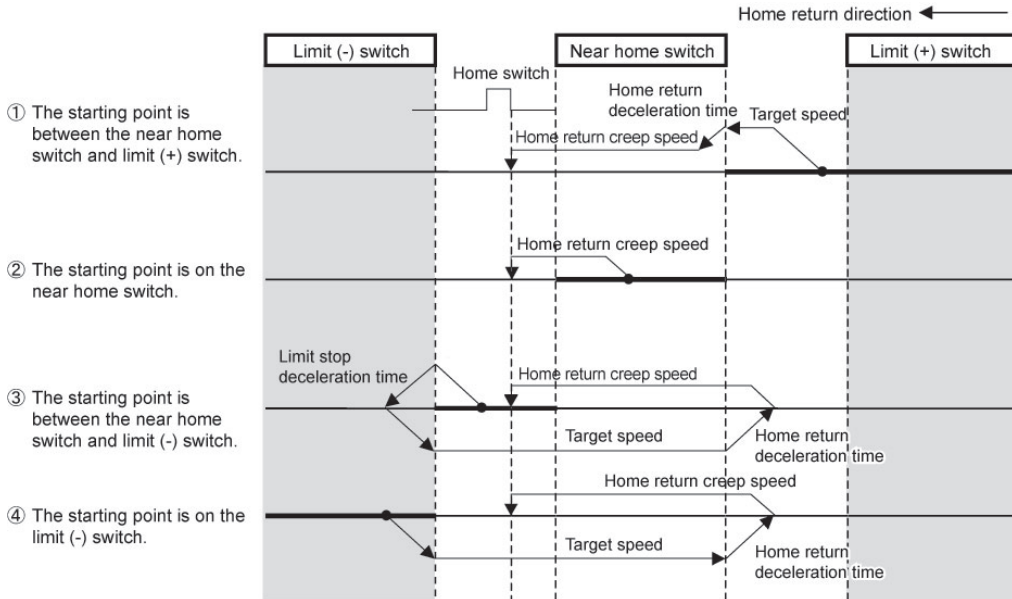

Note) When the home sensor is ON at startup, the operation is similar to ③.

■ **Limit method 1 (Edge detection of limit switch + First rising edge of home position as reference)**

Reverses after detecting the rising edge of the limit switch on the opposite side of the home return direction. The first rising edge of the home switch is detected. It becomes the start point.

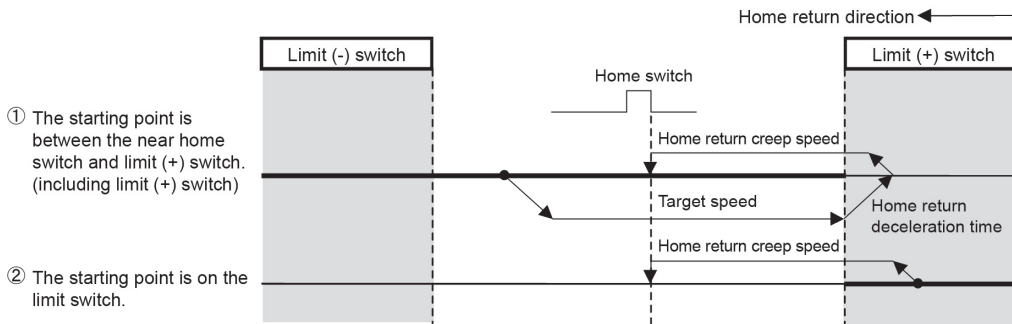

Note) When the home sensor is ON at startup, the operation is similar to ①.

Manual Operation (Home Return)

■ Limit method 2 (Edge detection of limit switch)

Detects the rising edge of the limit switch in the home return direction and stops. That point becomes the start point.

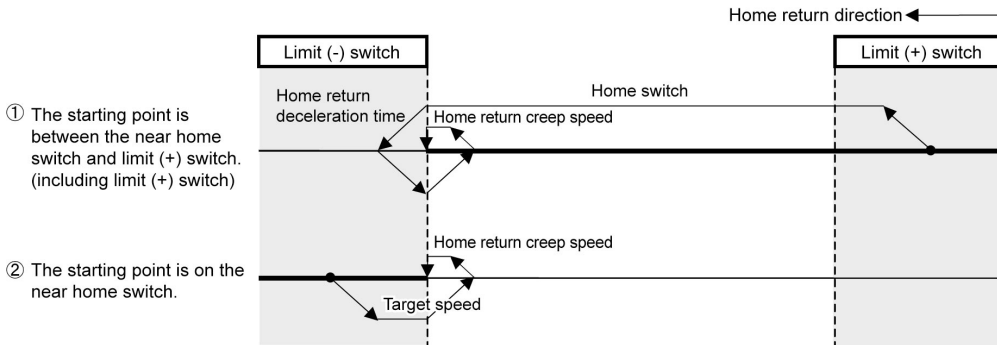

■ Home position method (Edge detection of home switch)

Moves from the current position in the home return direction, and detects the first rising edge of the home switch and stops. That point becomes the start point.

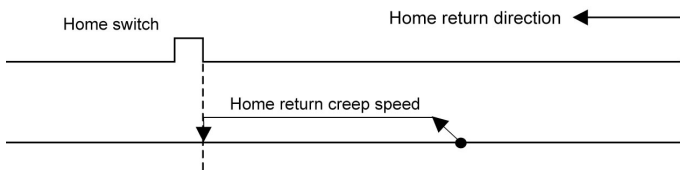

Note) When the home sensor is ON at startup, the unit does not detect the home sensor and operates to the home return direction.

■ Data set method

The current value is considered as the origin.

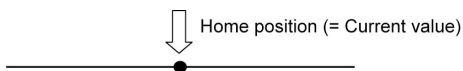

10.2 Setting and Operation of Home Return

The example below is a case of the positioning unit installed in the slot 1. Settings are made in pulses.

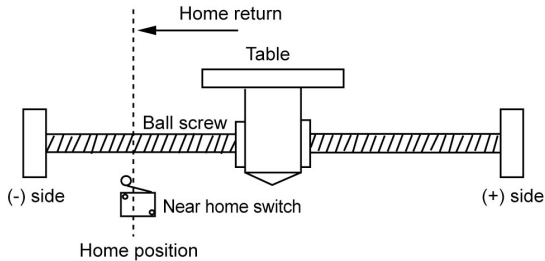

■ Settings

Parameters required for the home return operation of the positioning unit is set in the positioning setting menu of the programming tool.

Items	Setting example
Return setting code	0: DOG method 1
Return direction	0: Limit (-) direction
Acceleration time (ms)	100 ms
Deceleration time (ms)	100 ms
Target speed	10000 pps
Return creep speed	1000 pps
Deviation counter clear signal ON time	1 ms

■ Operation diagram

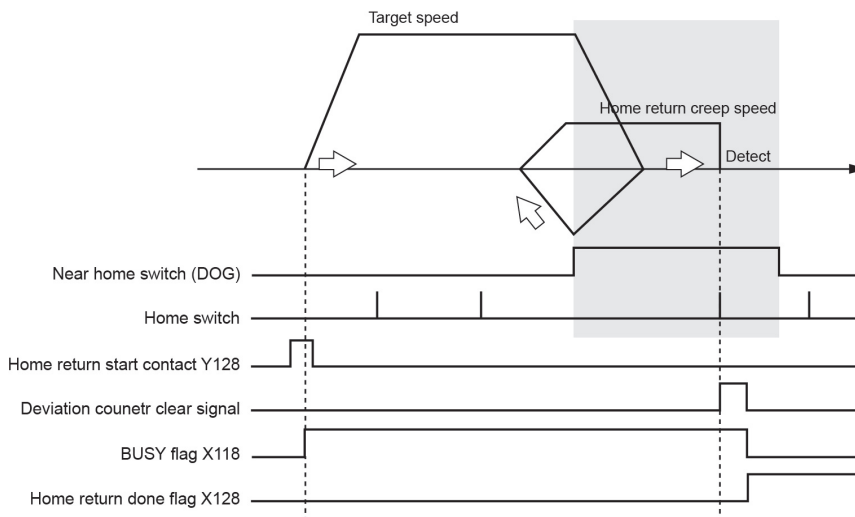

Manual Operation (Home Return)

■ Operation of each contact

- The BUSY flag (X118) indicating the state that a motor is running will turn ON when the home return of the positioning unit starts, and it will turn OFF when the operation completes.
- The deviation counter clear signal will turn ON during the ON time of the deviation counter clear signal on completion of the home return.
- The home return done flag (X128) indicating the state of operation completion will turn ON when the home return operation is completed, and it will be held until the next positioning control, JOG operation, home return, or pulser operation starts. The timing of that the flag turns ON is at the time that the home return operation is completed.

■ Sample program

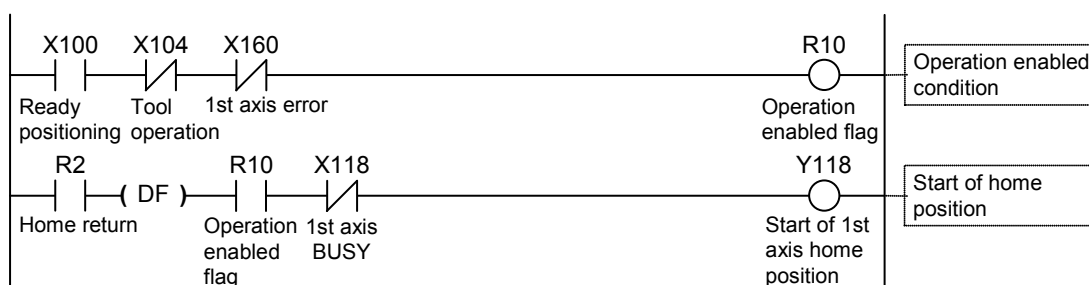

■ Programming Precautions

- The start contact and flag number varies depending on the number of axes and the installation position of the unit.
- The specified slot number varies depending on the installation position of the unit.

■ Operation at limit input

Condition	Direction	Limit status	Operation
When Home return operation is executed	Forward rotation	Limit input (+):ON	Executable
		Limit input (-):ON	Executable
	Reverse rotation	Limit input (+):ON	Executable
		Limit input (-):ON	Executable
During Home return operation	Forward rotation	Limit input (+):ON	Automatic reverse operation
	Reverse rotation	Limit input (-):ON	Automatic reverse operation

11

Manual Operation (Pulser Operation)

11.1 Setting and Operation of Pulser Operation

■ Types of Pulser Operation

Pulser operation is a function that uses a pulser connected to the positioning unit to output pulses manually.

The following pulser operation methods are available.

Operation method	Operation
Standard operation	Obtains the number of pulser pulses in 1-ms units and operates. Reflects the content of pulse input directly in the actual operation of the positioning unit.
Speed limits (pulses hold)	When the speed of pulse input exceeds the preset maximum speed, the operation will continue with the maximum speed maintained. The number of pulser pulses input will be maintained. Therefore, pulses not output will be maintained. Therefore, pulses may be output even if there is no pulser input. Speed unit is "Set unit x 1000/s".
Speed limits (Truncate)	When the speed of pulse input exceeds the preset maximum speed, the operation will continue with the maximum speed maintained. Pulses are output in synchronization with the operation of the pulser while pulses not output are discarded. Speed unit is "Set unit x 1000/s".

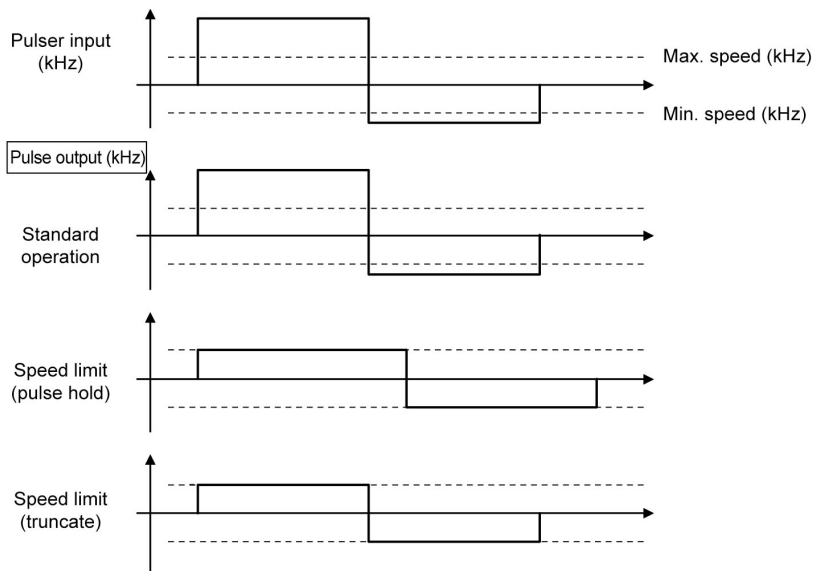

The example below is a case of the positioning unit installed in the slot 1. Settings are made in pulses.

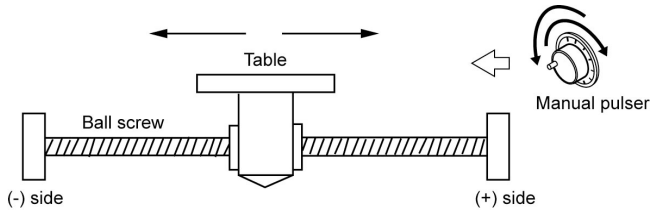

■ Settings

Parameters required for the pulser operation of the positioning unit is set in the positioning setting menu of the programming tool.

Items	Setting example	Settable range
Operation setting code	0: Pulser 1	0: Pulser 1 1: Pulser 2 2: Pulser 3 3: Pulser 4
Pulser operation ratio numerator	2	1 to 32,767
Pulser operation ratio denominator	1	1 to 32,767
Pulser operation method	2: Speed limits (truncated)	0: Standard operation 1: Speed limits (pulse hold) 2: Speed limits (truncated)
Pulser operation max. speed	500	Pulse: 1 to 32,767,000 pps

■ Operation diagram

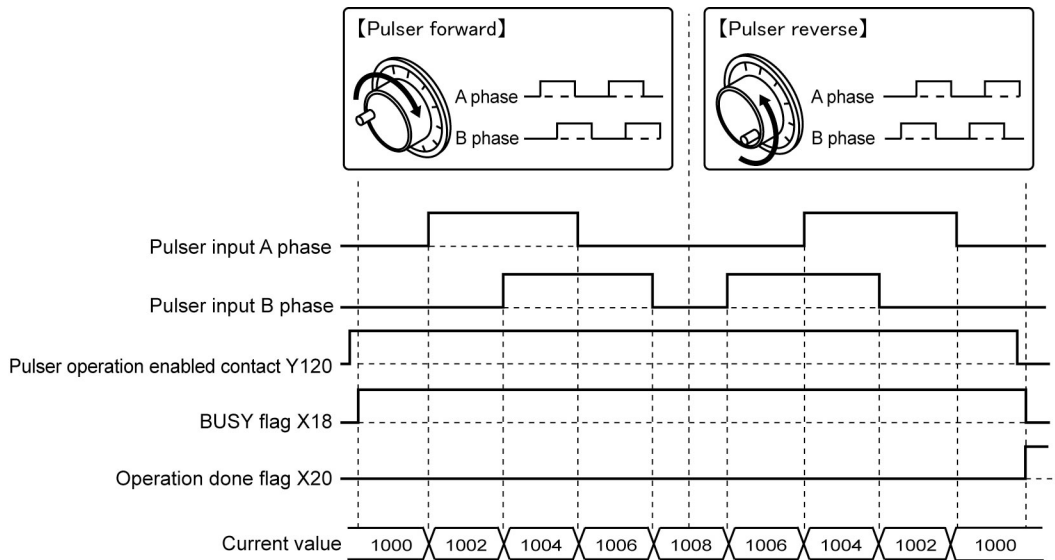

■ Operation of each contact

- The BUSY flag (X118) indicating the state that a motor is running will turn ON when the pulser operation permit contact turns ON and will turn OFF when the contact turns OFF.
- The operation done flag (X120) indicating the state of operation completion will turn ON when the pulser operation permit contact is turned OFF and the flag will be maintained until the next positioning control, JOG operation, home return, or pulser operation starts.

Manual Operation (Pulser Operation)

■ Sample program

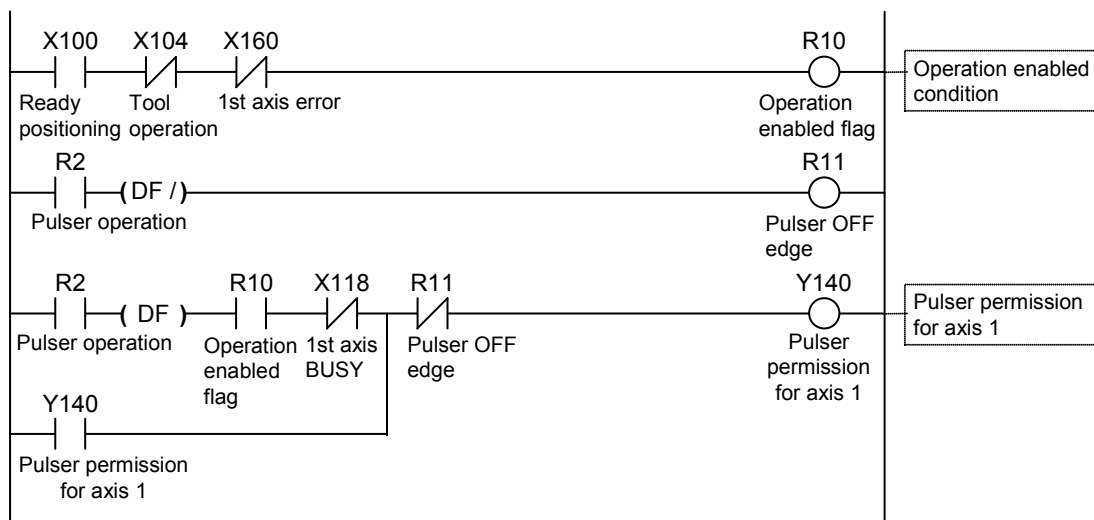

■ Programming Precautions

- The movement amount per an 1-pulse signal from the pulser can be changed by setting the ratio numerator and ratio denominator for the input signal of the pulser.
- The start contact and flag number varies depending on the number of axes and the installation position of the unit.
- The specified slot number varies depending on the installation position of the unit.

■ Operation at limit input

Condition	Direction	Limit status	Operation
When Pulser operation is executed	Forward rotation	Limit input (+):ON	Not executable, Error occurs.
		Limit input (-):ON	Executable
	Reverse rotation	Limit input (+):ON	Executable
		Limit input (-):ON	Not executable, Error occurs.
During Pulser operation	Forward rotation	Limit input (+):ON	Deceleration stop, Error occurs.
	Reverse rotation	Limit input (-):ON	Deceleration stop, Error occurs.

12

Stop Functions

12.1 Types and Settings of Stop Function

12.1.1 Type of Stop Operations

- The following seven stop operations are available.
- The system stop, emergency stop, deceleration stop, and pause will be effective when allocated output signals turn ON by user programs.
- The limit stop, software limit stop, and error stop will be effective when corresponding conditions are established.

■ Type of stop operations

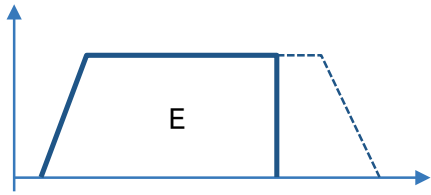
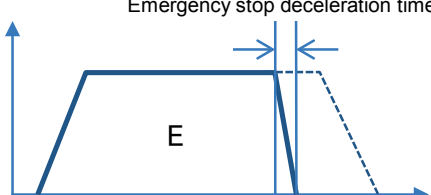
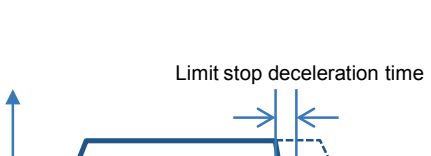
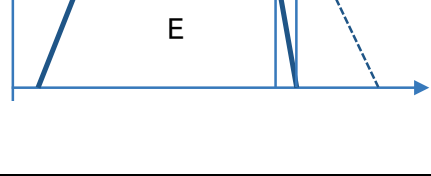
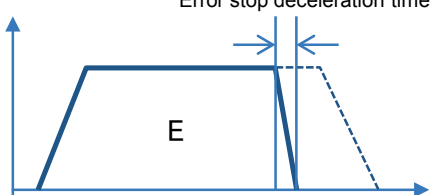
Name	Time chart	Occurrence condition and operation
System stop		<ul style="list-style-type: none"> • Once a system stop contact (Y0) turns ON, an active operation will stop and the pulse outputs of all axes will immediately stop. • Stops without deceleration time. • The similar operation is performed when the operation mode of the CPU unit is switched from RUN to PROG.
Emergency stop		<ul style="list-style-type: none"> • Once an emergency stop contact (Y30-Y37) turns ON, an active operation will stop and the pulse outputs of corresponding axes will stop. • Performs deceleration stop with the "emergency stop deceleration time" specified in the positioning parameter.
Limit stop		<ul style="list-style-type: none"> • Once a limit + input and limit - input (Y50-Y57) turns ON, an active operation will stop and the pulse outputs of corresponding axes will stop. • Performs deceleration stop with the "limit stop deceleration time" specified in the positioning parameter.
Software limit stop		<ul style="list-style-type: none"> • When the software limit function is effective, an active operation will stop and the pulse outputs of corresponding axes will stop when it exceeds the range of the software limit. • Performs deceleration stop with the "limit stop deceleration time" specified in the positioning parameter.
Error stop		<ul style="list-style-type: none"> • When a unit error occurs, the pulse outputs of corresponding axes (all axes or each axis) will stop. (Note 1) • Performs deceleration stop with the "error stop deceleration time" specified in the positioning parameter.

(Note 1):When a self-diagnostic error which stops the operation of the CPU unit occurs, the mode will be switched to the PROG. mode and the system stop will be executed.

Name	Time chart	Occurrence condition and operation
Deceleration stop (Note1)		<ul style="list-style-type: none"> ● Once a deceleration stop contact (Y38-Y3F) turns ON, an active operation will stop and the pulse outputs of corresponding axes will stop. ● Decelerates with the deceleration time specified for the active positioning operation.
Pause (Note1)		<ul style="list-style-type: none"> ● Once a deceleration stop contact (Y38-Y3F) turns ON, an active operation will stop and the pulse outputs of corresponding axes will stop. ● Decelerates with the deceleration time specified for the active positioning operation. ● Once a deceleration stop signal turns OFF, the deceleration stop will be canceled and the stopped control will restart.

(Note 1): The operations of deceleration stop and pause are switched by setting the system operation setting area of unit memory by user programs.

■ Allocation of I/O Numbers

Signal name	I/O number				
	1st axis	2nd axis	3rd axis	4th axis	Virtual axis
System stop	Y0				
Emergency stop (The operation is the level type.)	Y30	Y31	Y32	Y33	Y37
Deceleration stop (The operation is the level type.)	Y38	Y39	Y3A	Y3B	Y3F

(Note 1): The I/O numbers in the above table show relative addresses based on the base word number. I/O numbers actually used vary with the number of the slot where the unit is installed and the first word number.

■ Stop operation during interpolation control

- For executing the emergency stop, deceleration stop, or pause, turn on a contact corresponding to the smallest axis number in an interpolation group.
- In the case of limit stop, software limit stop or error stop, the stop operation will start once a corresponding condition is established on one of axes in an interpolation group.



◆ REFERENCE

- For details of the stop operation during synchronous control, refer to "8.2 Settings for Master and Slave Axes" and "8.3 Start and Cancel of Synchronous Control".

12.1.2 Stop time settings

Each stop time is specified for each axis on Configurator PM7.

■ Stop time settings

	1 axis	2 axis	3 axis	4 axis
Emergency stop deceleration time (ms)	100	100	100	100
Limit stop deceleration time (ms)	100	100	100	100
Error stop deceleration time (ms)	100	100	100	100
J-point - Operation setting code	U: Linear acceleration/de	U: Linear acceleration/de	U: Linear acceleration/de	U: Linear acceleration/de
J-point - Acceleration time (ms)	100	100	100	100

Item	Description
Emergency stop deceleration time	Set the deceleration time at the time of emergency stop. 0 to 10000ms (Default: 100 ms)
Limit stop deceleration time	Set the deceleration time at the time of limit stop and software limit stop. 0 to 10000ms (Default: 100 ms)
Error stop deceleration time	Set the deceleration time at the time of error stop. 0 to 10000ms (Default: 100 ms)

12.2 Operation During Stop

■ Operation during stop

- The system stop, emergency stop, deceleration stop and pause is performed by turning on each request contact in the I/O area.
- The stopped state is held while each contact is on until each request signal turns off. Any operation cannot be performed in the stopped state. It is also the same in the cases of limit stop, software limit stop and error stop.

■ Priority of stop operations

- When stop control requests are made simultaneously, the stop operations will be executed according to the following priority.

(1) System stop > (2) Error stop > (3) Software limit stop > (4) Limit stop > (5) Emergency stop > (6) Pause > (7) Deceleration stop

■ Dwell time setting

- The dwell time setting is invalid in the stop operations regardless of patterns.
- However, the dwell time setting is invalid in the positioning operation after a pause.

■ Flag processing

- In the case of system stop, the busy signal turns off and the operation done signal turns on.
- In the cases of emergency stop, limit stop, software limit stop, error stop and deceleration stop, the busy signal turns off and the operation done signal turns on after the completion of the pulse output during deceleration.

■ Current value coordinate

- Even in a stop operation, the current value coordinate area is always updated.
- After the emergency stop, limit stop, software limit stop, error stop, deceleration stop or pause, deceleration is performed with each specified deceleration time, and the value when the pulse output stops is stored.
- In the case of system stop, the value when the pulse output stops is stored.

12.3 Pause function

12.3.1 Pause Function

- The pause function temporarily stops operation. Toggle between the pause function and the deceleration stop function for use.
- The pause function performs a deceleration stop in the deceleration time of operation when the deceleration stop request contact turns ON. After that, the stopped state is kept while the deceleration stop request contact (Y38 to Y3F) is on, and the control stopped is restarted by turning off the deceleration stop request contact.



◆ KEY POINTS

- **No deceleration stop can be executed while the pause function is in use. Use the emergency stop function in the case of executing a stop while the pause function is in use.**
- **The pause function is enabled only when the positioning unit is in automatic operation (positioning control). During a manual operation (JOG operation/home return/pulser operation), it is the same operation as a deceleration stop.**
- **Like other stop functions, the pause function will maintain the stop state while the deceleration stop (pause) request signal is ON. The pause will be canceled if an emergency stop or system stop is executed while the positioning unit is not operating, and the positioning unit will go into the emergency stop or system stop state.**

12.3.2 Setting of Pause

- The operations of deceleration stop and pause are switched by setting the system operation setting area (UM00389) of unit memory by user programs.

System operation setting area

Unit memory no. (Hex)	Name	Default	Description
UM 00389	Deceleration stop operation	0	<p>Specify the operation of the positioning unit with the deceleration stop request signal activated (turned ON).</p> <p>0: Deceleration stop</p> <p>While the positioning unit is in repetitive control, the positioning unit will come to a stop after the position moves to E point of the repetitive target.</p> <p>1: Pause</p> <ul style="list-style-type: none"> ● Performs a deceleration stop, and positioning will restart when the deceleration stop request signal is canceled (turned OFF). ● The positioning unit will perform the same operation as a deceleration stop unless the positioning unit is in positioning operation. ● While the positioning unit is in repetitive operation, the positioning unit will come to a stop after the position moves to the E point of the repetitive target, and repetitive control will restart when the deceleration stop request signal is canceled (turned OFF). ● If a system stop or emergency stop is executed while the positioning unit is paused, the pause state will be canceled and the operation will not restart with the deceleration stop request signal is canceled (turned OFF).

13

Supplementary Functions

13.1 Dwell Time

The time taken until the next operation after the completion of an executed positioning table in the automatic operation is called dwell time.

■ For E-point control

The dwell time is the time taken from the completion of the position reference until the operation done flag turns ON.

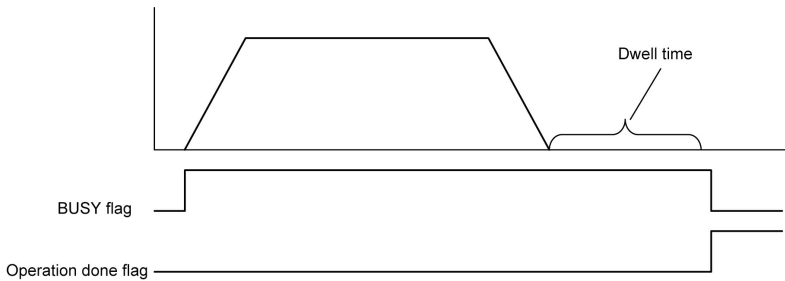

■ For P-point control

While the positioning unit is in P-point control, the positioning table will operate consecutively, and the dwell time will be ignored. For the last table (E point), like E-point control, dwell time is a period required from the completion of the position reference until the operation done flag turns ON.

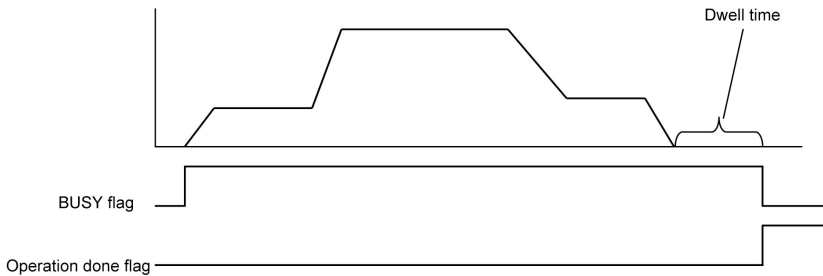

■ For C-point control

The dwell time is the waiting time for executing the next table from the completion of the positioning table (deceleration stop). For the last table (E point), like E-point control, dwell time is a period required from the completion of the position reference until the operation done flag turns ON.

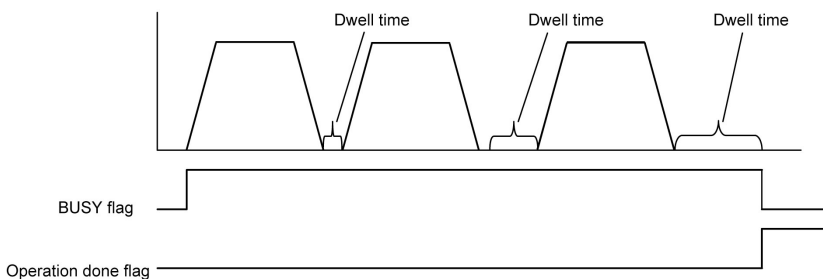

13.2 Software Limit

The system is designed to mechanically set the limit (+) and limit (-) to restrict the moving range of a motor.

Separately from the mechanical limits (+) and (-), the software limit is a function to add the limits for the absolute coordinate managed within the positioning unit. As the software limit is a function for the protection of the motor and AMP, it is recommended to set them to the values within the range of the mechanical limits (+) and (-) as below.

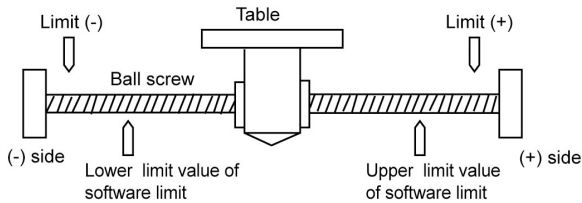

If the operating range of the motor exceeds the setting range of the software limit (upper and lower limit values), an error will occur, and the deceleration stop will be executed. It is necessary to clear the error and move the motor into the range of the software limit using an operation such as JOG operation after the stop.

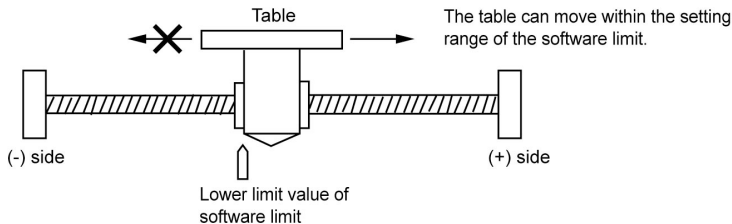

Whether the software limit enabled or disabled can be specified individually for the positioning control, JOG operation, and home return operation. For example, it is possible to disable the limit software only in home return operation.

13.3 Auxiliary Output Code and Auxiliary Output Contact

The auxiliary output contact is a function to announce externally which table is in operation when the automatic operation (E-point control, C-point control, P-point control, and J-point control) is executed.

The auxiliary output contact and auxiliary output code are available by setting parameter auxiliary output to With mode or Delay mode on an axis-by-axis basis.

■ Auxiliary output contact

The auxiliary output contact operates either in With mode or Delay mode.

Auxiliary output mode	Operation
With mode	When the automatic operation starts, the auxiliary contact flag of the corresponding axis allocated to I/O will turn ON.
Delay mode	<p>The auxiliary contact flags for corresponding axes allocated to the I/O area will turn ON according to the ratio of positioning movement (%) while the positioning unit is in automatic operation.</p> <p>The turn ON ratio while the positioning unit is in Delay mode is set in the Delay ratio area of auxiliary output in the unit memory.</p> <p>There will be no difference between the With mode and Delay mode in operation if J-point control is set for the automatic operation of the positioning unit.</p>

The ON time of the auxiliary contact flag can be specified in ms increments.



◆ NOTE

There will be no difference between the Delay mode and With mode in operation while the positioning unit is in J-point control.

■ Auxiliary output data

The auxiliary output data (1 word) can be set for each table of the positioning data. The content of the process currently carried out can be confirmed by setting auxiliary output.

The values in the auxiliary output data are held until the next positioning table is executed. The auxiliary output data that was output just before the completion of the automatic operation is held.

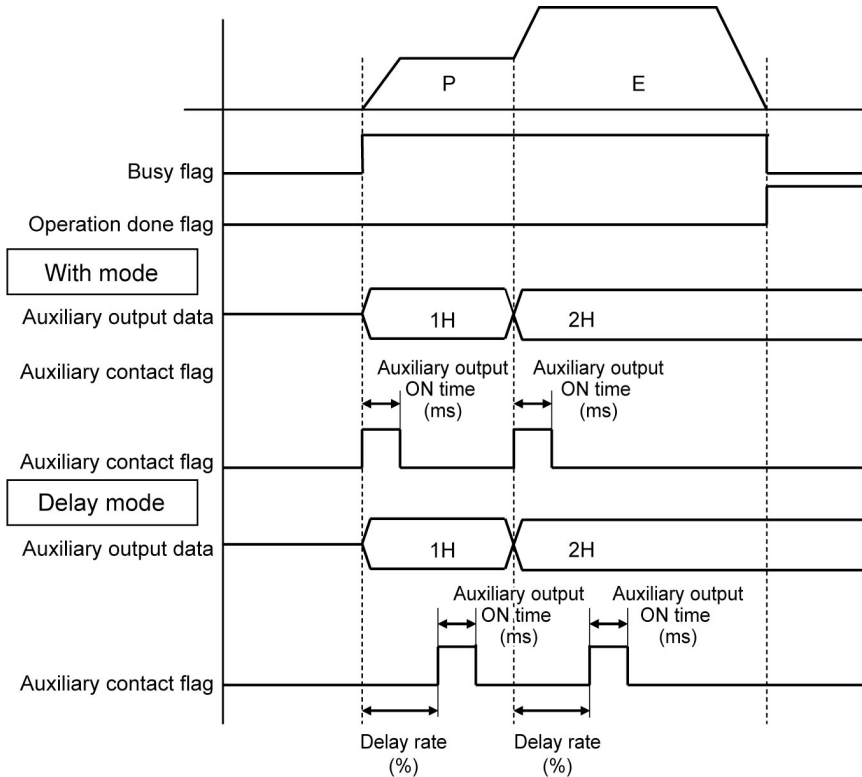

◆ NOTE

Auxiliary output data will maintain the value regardless of the type of auxiliary output mode (the with mode or delay mode) until the next positioning table is executed.

13.4 Current Value Update

The current value update function is a function to change the current value controlled by the positioning unit to a desired (preset) value.

Refreshing the current value requires data writing to the unit memory.

■ Current value update area (Unit memory)

Unit memory no. (Hex)	Name	Description																																	
UM 000C0	Current value update request flag	Only when the corresponding bit for each axis changes to 1 from 0, the current coordinate controlled by the positioning unit to the following current value. After the change, the positioning unit will clear the corresponding bits to 0 automatically.																																	
		<table border="1"> <thead> <tr> <th>bit</th> <th>Name</th> <th>Default</th> <th>Description</th> </tr> </thead> <tbody> <tr> <td>0</td> <td>Current value update request for 1st axis</td> <td>0</td> <td rowspan="8">0: No change 1: Changes the corresponding coordinate origin. (After change, the positioning unit clears the corresponding bits to 0 automatically.)</td> </tr> <tr> <td>1</td> <td>Current value update request for 2nd axis</td> <td>0</td> </tr> <tr> <td>2</td> <td>Current value update request for 3rd axis</td> <td>0</td> </tr> <tr> <td>3</td> <td>Current value update request for 4th axis</td> <td>0</td> </tr> <tr> <td>4</td> <td>–</td> <td>–</td> </tr> <tr> <td>5</td> <td>–</td> <td>–</td> </tr> <tr> <td>6</td> <td>–</td> <td>–</td> </tr> <tr> <td>7</td> <td>Current value update request for virtual axis</td> <td>0</td> </tr> <tr> <td>15 to 8</td> <td>–</td> <td>–</td> <td>–</td> </tr> </tbody> </table>	bit	Name	Default	Description	0	Current value update request for 1st axis	0	0: No change 1: Changes the corresponding coordinate origin. (After change, the positioning unit clears the corresponding bits to 0 automatically.)	1	Current value update request for 2nd axis	0	2	Current value update request for 3rd axis	0	3	Current value update request for 4th axis	0	4	–	–	5	–	–	6	–	–	7	Current value update request for virtual axis	0	15 to 8	–	–	–
		bit	Name	Default	Description																														
		0	Current value update request for 1st axis	0	0: No change 1: Changes the corresponding coordinate origin. (After change, the positioning unit clears the corresponding bits to 0 automatically.)																														
		1	Current value update request for 2nd axis	0																															
		2	Current value update request for 3rd axis	0																															
		3	Current value update request for 4th axis	0																															
		4	–	–																															
		5	–	–																															
		6	–	–																															
7	Current value update request for virtual axis	0																																	
15 to 8	–	–	–																																
UM 000C8	Current value update coordinate of 1st axis	Stores the coordinate to be preset as the current value of 1st axis.																																	
UM 000C9																																			
UM 000CA	Current value update coordinate of 2nd axis	Stores the coordinate to be preset as the current value of 2nd axis.																																	
UM 000CB																																			
UM 000CC	Current value update coordinate of 3rd axis	Stores the coordinate to be preset as the current value of 3rd axis.																																	
UM 000CD																																			
UM 000CE	Current value update coordinate of 4th axis	Stores the coordinate to be preset as the current value of 4th axis.																																	
UM 000CF																																			
UM 000D6	Current value update coordinate of virtual axis	Stores the coordinate to be preset as the current value of virtual axis..																																	
UM 000D7																																			

■ Current value update procedure

1. Write a coordinate to be preset in the current value update coordinate area of the axis to update the current value.
2. Preset the target axis bit to 1 in the current value update request flag area. As the current value update process is performed for the axis that is 1 in the current value request flag area, do not set any bit to 1 other than the target axis.
3. The current value after unit conversion in each axis information and monitor area is changed to the specified current value.



◆ **NOTE**

The value to be changed by updating the current value is the current value after unit conversion.

13.5 Coordinate Origin

The positioning unit performs a home return to set the managing coordinate to 0.

The coordinate origin is a function that allows to set the coordinate to a desired value after home return processing.

■ **Coordinate origin processing procedure**

1. Write a coordinate to be the home in the home coordinate area of the target axis for which the coordinate is to be changed after a home return.
2. Execute the home return process. After the completion of the home return, the coordinate specified in the above 1 will become the home position.

Unit memory no. (Hex)	Name	Default	Setting range and description
UM 0084A UM 0084B	Coordinate origin of 1st axis	-	Stores the value of coordinate origin after the home return.
UM 0304A UM 0304B	Coordinate origin of 2nd axis		
UM 0584A UM 0584B	Coordinate origin of 3rd axis		
UM 0804A UM 0804B	Coordinate origin of 4th axis		
UM 1204A UM 1204B	Coordinate origin of virtual axis		



◆ **NOTE**

Set the coordinate origin in the specified unit.

13.6 Pulse Input

13.6.1 Pulse Input Types

Each axis of the positioning unit has pulse input, thus connecting to a variety of input devices. Select the desired type of pulse input in the positioning setting menu of the tool software.

■ Purpose of pulse input

Input target	Description
Pulser	<ul style="list-style-type: none"> • Select this to use manual pulsers. • The use of a pulser operation setting code allows to specify the target axis (ch) where the pulser will be used.
Feedback pulse	<p>Set feedback pulse input in the case of connecting an encoder in order to monitor the rotation of the motor.</p> <ul style="list-style-type: none"> • When feedback pulse input is selected, the positioning unit uses pulse input to perform the feedback pulse count of its own axis, thus detecting the difference between the instruction value and pulse input value. (Automatic check function of movement amount)
High-speed counter	<ul style="list-style-type: none"> • Set high-speed counter input to be used as general-purpose counter input. High-speed counter input supports a variety of input types (i.e., two-phase input, direction discrimination input, and individual input). • The positioning unit stores the number of input pulses in the monitor area.

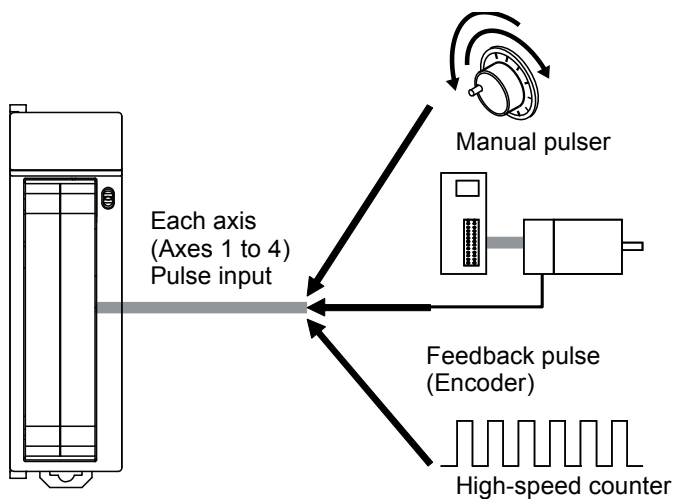

13.6.2 Restrictions on Combinations of Pulse Inputs

■ Restrictions on combinations of pulse inputs

			Pulse input purpose		
			Pulsar	Feedback pulse	High-speed counter
Pulse input mode parameter	Rotation direction	Forward	Available	Available	Available
		Reverse	Available	Available	Available
	Input mode	2-phase input	Available	Available	Available
		Direction discrimination input	Not available	Not available	Available
		Individual input	Not available	Not available	Available
	Multiple	1 multiple	Not available	Available	Available
		2 multiple	Not available	Available	Available
		4 multiple	Available	Available	Available
	Pulse input	Enable	Available	Available	Available
		Disable	Not available	Not available	Available
	Pulse count value	Clear	Not available	Available	Not available
		Set	Not available	Available	Available

13.6.3 Input Mode to Pulse Input

- Select from the following three types according to input devices to be connected.
- The count operation varies depending on the settings of multiplication factor as shown on the next page.

■ Input method to pulse input

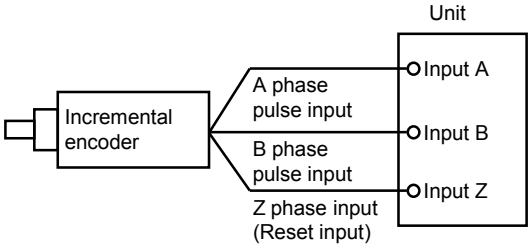
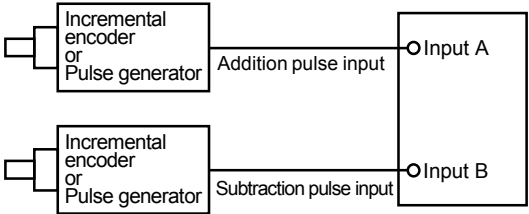
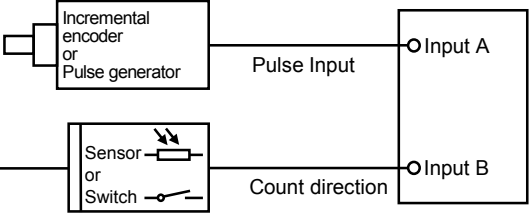
Method	Connection	Count
2-phase (Phase difference)		<p>For the 2-phase input, the input A signal and input B signal of each counter are connected to the phase A and phase B of an encoder.</p> <p>The count direction depends on the phase difference between phases A and B. When the phase A is proceeding by 90 degrees in electrical angle than the phase B, the count value is incremented. When the phase A is delayed by 90 degrees in electrical angle than the phase B, the count value is decremented.</p>
Individual		<p>In the individual input method, the counter is incremented when the input A signal rises or falls, and decremented when the input B signal rises or falls.</p>
Direction discrimination		<p>For the direction detection input, the count signal is connected to the input A signal. The count direction is controlled by the level of the direction signal of input B signal.</p> <p>When the input B signal is off, the counter is incremented when the input A signal rises or falls. When the input B signal is on, the counter is decremented.</p>

Supplementary Functions

Count operation of 2-phase input (Phase difference input)

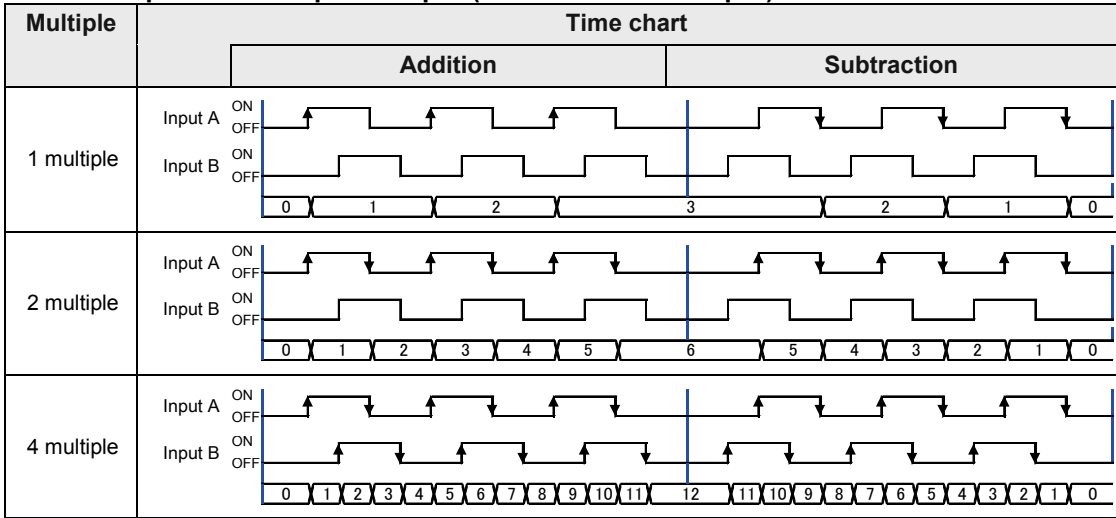

Count operation of individual input

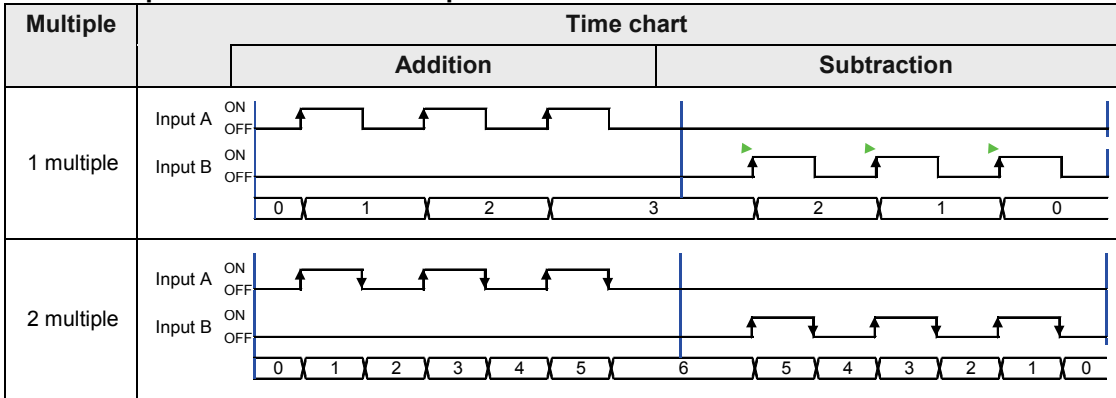

Count operation of direction discrimination input

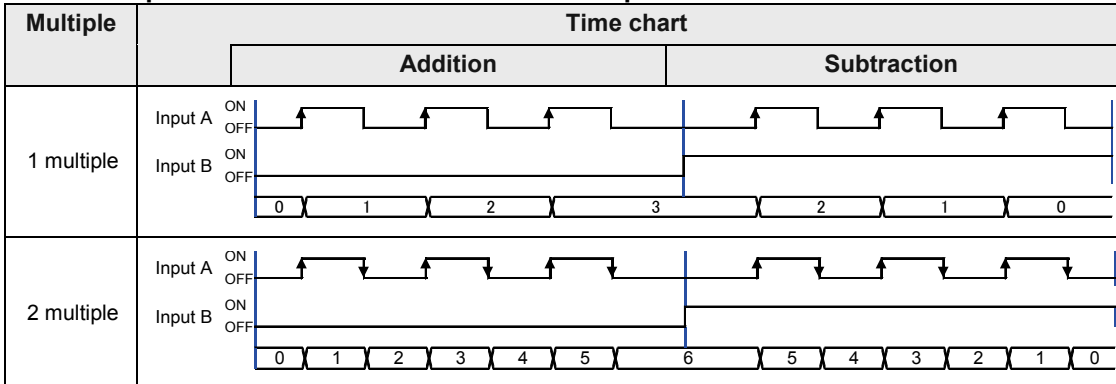

13.6.4 Monitoring Pulse Input Values

The positioning unit can monitor pulse input from programs.

Pulse input monitoring uses the following areas.

Unit memory no. (Hex)	Name	Description
UM 00436	Pulse input value of 1st axis	Pulse input values are stored according to the pulse input application (e.g., pulser, feedback pulse, or high-speed counter). (Unit: pulse) Pulse input values are integrated and stored, and will be cleared if the pulse input application is changed or when the pulse input values are cleared.
UM 00437		
UM 00476	Pulse input value of 2nd axis	
UM 00477		
UM 004B6	Pulse input value of 3rd axis	
UM 004B7		
UM 004F6	Pulse input value of 4th axis	
UM 004F7		

13.6.5 Pulsar Input Function

By setting the positioning unit to pulsar for the pulse input application, a manual pulsar can be used.

Settings allow manual pulsars to connect to different axes. Therefore, a single pulsar can operate a number of axes simultaneously. However, pay attention to settings for the axis connected to the pulsar and the axes operated by the pulsar.

Refer to the following table and make settings for the pulse input application.

Settings for pulse input application		Pulsar operation	
Pulsar connecting axis	Pulsar operating axis	Operation	Outline
Feedback pulse	Feedback pulse	No	The positioning unit does not recognize pulse input as the manual pulsar, thus not allowing the operation of the pulsar.
High-speed counter	High-speed counter Pulsar		
Pulsar	Feedback pulse	Yes	The pulsar operates. The feedback pulse function is available while the pulsar is in operation.
	High-speed counter	Yes	The pulsar operates. The high-speed counter function is available while the pulsar is in operation.
	Pulsar	Yes	The pulsar operates.

13.6.6 Feedback Pulse Function

By setting the pulse input application to feedback pulse, the positioning unit can use the function to utilize feedback pulses from the encoder.

■ Automatic check function of movement amount

The automatic check function of movement amount is used to check whether each axis in operation is operating according to the instruction value, and the function compares the difference between the current value (absolute) under the internal control of the unit and the feedback pulse input (deviation) with a threshold preset. The automatic check function of movement amount works for all types of operation.

The automatic check function of movement amount will work only if the pulse input application is set to feedback pulse, and will not work if it is set to pulsar or high-speed counter.

- The movement amount automatic check function can also be used during synchronous control. (This function is available for the unit of Ver.1.50 or later.) However, when the pulse input is used as the master axis, do not use the movement amount automatic check function for that axis..

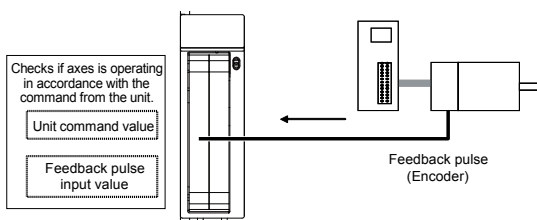

The automatic check function of movement amount is set in the following areas.

1st axis

Unit memory no. (Hex)	Name	Description
UM 00808	Numerator of automatic movement amount check correction	Set a correction value of pulse input at the time of making an automatic movement amount check.
UM 00809	Denominator of automatic movement amount check correction	The following formula is used to calculate a deviation feedback value (pulse input value with a correction) from pulse input and make an automatic movement amount check. Deviation feedback value = (Correction numerator/Correction denominator) x Pulse input
UM 0080A	Automatic movement amount checking	Set an action when the difference between the instruction value and feedback value exceeds the movement check value at the time of automatic movement amount check. 0: Error An error will occur and the operation of the positioning unit will come to a stop if the difference between the feedback value and reference movement exceeds the movement check value (threshold). The pulse input will be cleared when the error is cleared. 1: Warning A warning will occur and the operation of the positioning unit will come to a stop if the difference between the feedback value and reference movement exceeds the movement check value (threshold). The pulse input will be cleared when the warning is cleared. 2: No No movement check is made.
UM 00818	Automatic movement amount check value	Set the threshold to use the automatic check function of movement amount.
UM 0081A	Automatic movement amount check interval	Set the interval of automatic movement amount checking (Unit: ms)

2nd axis

Unit memory no. (Hex)	Name	Description
UM 03008	Numerator of automatic movement amount check correction	Refer to the description for the 1st axis.
UM 03009	Denominator of automatic movement amount check correction	
UM 0300A	Automatic movement amount checking	
UM 03018	Automatic movement amount check value	
UM 0301A	Automatic movement amount check interval	

3rd axis

Unit memory no. (Hex)	Name	Description
UM 05808	Numerator of automatic movement amount check correction	Refer to the description for the 1st axis.
UM 05809	Denominator of automatic movement amount check correction	
UM 0580A	Automatic movement amount checking	
UM 05818	Automatic movement amount check value	
UM 0181A	Automatic movement amount check interval	

4th axis

Unit memory no. (Hex)	Name	Description
UM 08008	Numerator of automatic movement amount check correction	Refer to the description for the 1st axis.
UM 08009	Denominator of automatic movement amount check correction	
UM 0800A	Automatic movement amount checking	
UM 08018	Automatic movement amount check value	
UM 0801A	Automatic movement amount check interval	

■ Operation of automatic check function of movement amount

The automatic check function of movement amount operates in the following procedure while the positioning unit is in operation.

1. The current position of the positioning unit will be saved in the unit the moment the positioning unit starts operating.
2. After the positioning unit starts operating, the automatic check function of movement amount will come to a stop until the automatic movement check interval elapses.
3. After the movement amount automatic interval elapses, the deviation feedback value calculated from the current pulse input value will be compared with the saved pulse input value, and the difference (deviation) will be checked whether it is in excess of the value set for the automatic movement check value.
4. The current position of the positioning unit will be saved in the unit.
5. Steps 2 to 4 above will be repeated.



◆ NOTE

Set the automatic movement check interval with consideration of the response time of the encoder in use.

■ Deviation monitoring

The value (deviation) calculated by the automatic check function of movement amount can be checked with the program.

The deviation monitor uses the following areas.

Unit memory no. (Hex)	Name	Description
UM 00434	Deviation of 1st axis	The maximum value of the deviation (the difference between the pulse input value and instruction value) will be stored.
UM 00435		
UM 00474	Deviation of 2nd axis	
UM 00475		
UM 004B4	Deviation of 3rd axis	
UM 004B5		
UM 004F4	Deviation of 4th axis	
UM 004F5		

■ Clearing pulse input value

Pulses input as feedback pulses are integrated and stored as a pulse input value.

The pulse input value will be cleared at completion of home return when feedback pulses are used for the pulse input application.

Supplementary Functions

■ Changing pulse input value

If the pulse input application is set to feedback pulse, the pulse input value can be changed to a desired value.

The following areas are used to change the pulse input value.

Unit memory no. (Hex)	Name	Description																					
UM 00241	Pulse count value change request flag	<p>The pulse input value will be changed to the set pulse count when the corresponding bit for each axis is set to 1 from 0.</p> <p>This flag is an edge trigger. Be sure to change the flag to 1 from 0 at the time of the change. After the change, the positioning unit will clear the corresponding bits to 0 automatically.</p> <table border="1"> <thead> <tr> <th>bit</th> <th>Name</th> <th>Default</th> <th>Description</th> </tr> </thead> <tbody> <tr> <td>0</td> <td>Pulse count change of 1st axis</td> <td>0</td> <td rowspan="4">0: The pulse input value is not changed. 0→1: Pulse input value change</td> </tr> <tr> <td>1</td> <td>Pulse count change of 2nd axis</td> <td>0</td> </tr> <tr> <td>2</td> <td>Pulse count change of 3rd axis</td> <td>0</td> </tr> <tr> <td>3</td> <td>Pulse count change of 4th axis</td> <td>0</td> </tr> <tr> <td>15 to 4</td> <td>–</td> <td>–</td> <td>–</td> </tr> </tbody> </table>	bit	Name	Default	Description	0	Pulse count change of 1st axis	0	0: The pulse input value is not changed. 0→1: Pulse input value change	1	Pulse count change of 2nd axis	0	2	Pulse count change of 3rd axis	0	3	Pulse count change of 4th axis	0	15 to 4	–	–	–
bit	Name	Default	Description																				
0	Pulse count change of 1st axis	0	0: The pulse input value is not changed. 0→1: Pulse input value change																				
1	Pulse count change of 2nd axis	0																					
2	Pulse count change of 3rd axis	0																					
3	Pulse count change of 4th axis	0																					
15 to 4	–	–	–																				
UM 00248	Pulse input value change of 1st axis	Set the desired pulse input value for the 1st axis.																					
UM 00249																							
UM 0024A	Pulse input value change of 2nd axis	Set the desired pulse input value for the 2nd axis.																					
UM 0024B																							
UM 0024C	Pulse input value change of 3rd axis	Set the desired pulse input value for the 3rd axis.																					
UM 0024D																							
UM 0024E	Pulse input value change of 4th axis	Set the desired pulse input value for the 4th axis.																					
UM 0024F																							

13.6.7 High-speed Counter Function

By setting the positioning unit to high-speed counter for the pulse input application, pulse input can be used as an external counter.

■ Controlling pulse input

By setting the positioning unit to high-speed counter for the pulse input application, the pulse input count can be stopped as desired. The current pulse input value will be kept on hold when the pulse input count is stopped.

The pulse input count is enabled or disabled with settings in the following areas.

Unit memory no. (Hex)	Name	Description																					
UM 00240	Pulse count enable flag	<p>The pulse input value will be changed to the set pulse count when the corresponding bit for each axis is set to 0 from 1.</p> <table border="1"> <thead> <tr> <th>bit</th> <th>Name</th> <th>Default</th> <th>Description</th> </tr> </thead> <tbody> <tr> <td>0</td> <td>1st axis pulse count enabled</td> <td>0</td> <td rowspan="4">0: Pulse count enabled 1: Pulse count disabled</td> </tr> <tr> <td>1</td> <td>2nd axis pulse count enabled</td> <td>0</td> </tr> <tr> <td>2</td> <td>3rd axis pulse count enabled</td> <td>0</td> </tr> <tr> <td>3</td> <td>4th axis pulse count enabled</td> <td>0</td> </tr> <tr> <td>15 to 4</td> <td>–</td> <td>–</td> <td>–</td> </tr> </tbody> </table>	bit	Name	Default	Description	0	1st axis pulse count enabled	0	0: Pulse count enabled 1: Pulse count disabled	1	2nd axis pulse count enabled	0	2	3rd axis pulse count enabled	0	3	4th axis pulse count enabled	0	15 to 4	–	–	–
bit	Name	Default	Description																				
0	1st axis pulse count enabled	0	0: Pulse count enabled 1: Pulse count disabled																				
1	2nd axis pulse count enabled	0																					
2	3rd axis pulse count enabled	0																					
3	4th axis pulse count enabled	0																					
15 to 4	–	–	–																				

■ Changing pulse input value

If the pulse input application is set to high-speed counter, the pulse input value can be changed to a desired value.

The following areas are used to change the pulse input value.

Unit memory no. (Hex)	Name	Description																					
UM 00241	Pulse count value change request flag	<p>The pulse input value will be changed to the set pulse count when the corresponding bit for each axis is set to 1 from 0.</p> <p>This flag is an edge trigger. Be sure to change the flag to 1 from 0 at the time of the change. After the change, the positioning unit will clear the corresponding bits to 0 automatically.</p> <table border="1"> <thead> <tr> <th>bit</th> <th>Name</th> <th>Default</th> <th>Description</th> </tr> </thead> <tbody> <tr> <td>0</td> <td>Pulse count change of 1st axis</td> <td>0</td> <td rowspan="4">0: Pulse input value not changed. 0→1: Pulse input value change</td> </tr> <tr> <td>1</td> <td>Pulse count change of 2nd axis</td> <td>0</td> </tr> <tr> <td>2</td> <td>Pulse count change of 3rd axis</td> <td>0</td> </tr> <tr> <td>3</td> <td>Pulse count change of 4th axis</td> <td>0</td> </tr> <tr> <td>15 to 4</td> <td>–</td> <td>–</td> <td>–</td> </tr> </tbody> </table>	bit	Name	Default	Description	0	Pulse count change of 1st axis	0	0: Pulse input value not changed. 0→1: Pulse input value change	1	Pulse count change of 2nd axis	0	2	Pulse count change of 3rd axis	0	3	Pulse count change of 4th axis	0	15 to 4	–	–	–
bit	Name	Default	Description																				
0	Pulse count change of 1st axis	0	0: Pulse input value not changed. 0→1: Pulse input value change																				
1	Pulse count change of 2nd axis	0																					
2	Pulse count change of 3rd axis	0																					
3	Pulse count change of 4th axis	0																					
15 to 4	–	–	–																				
UM 00248	Pulse input value change of 1st axis	Set the desired pulse input value for the 1st axis.																					
UM 00249																							
UM 0024A	Pulse input value change of 2nd axis	Set the desired pulse input value for the 2nd axis.																					
UM 0024B																							
UM 0024C	Pulse input value change of 3rd axis	Set the desired pulse input value for the 3rd axis.																					
UM 0024D																							
UM 0024E	Pulse input value change of 4th axis	Set the desired pulse input value for the 4th axis.																					
UM 0024F																							

13.7 Startup speed

The positioning unit allows startup speed settings for the startup of each type of operation. The startup speed is available for positioning, JOG operation, and home return control.

■ Setting method of startup speed

Set the startup speed in the parameter-setting menu for each axis of the Configurator PM7.

■ Cautions for start speed settings

1. The startup speed will apply to the end of operation as well. The speed at the end of operation cannot be changed.
2. The home return creep speed at the time of a home return will not be influenced by the start speed.
3. The start speed.
4. The target speed of each type of operation is not influenced by the start speed. The positioning unit operates at the preset target speed regardless of the preset startup speed.

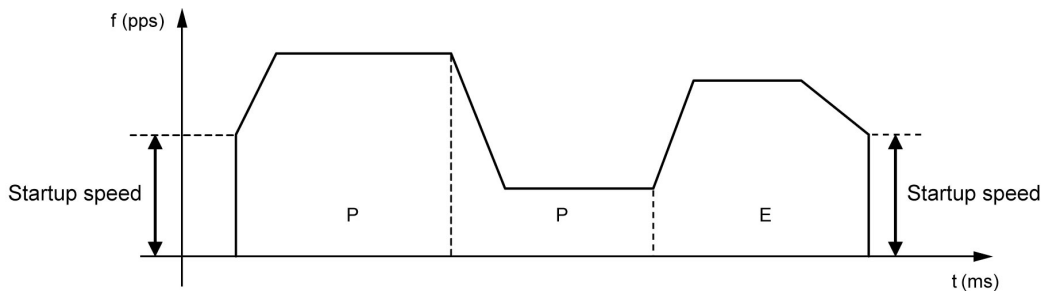

13.8 Target Speed Change Function (For unit version Ver.1.3 or later only)

13.8.1 Function Explanation

The target speed change function is used to change the target speed on an active positioning table to an arbitrary speed. Even when the speed changes, the operation amount in the table does not change.

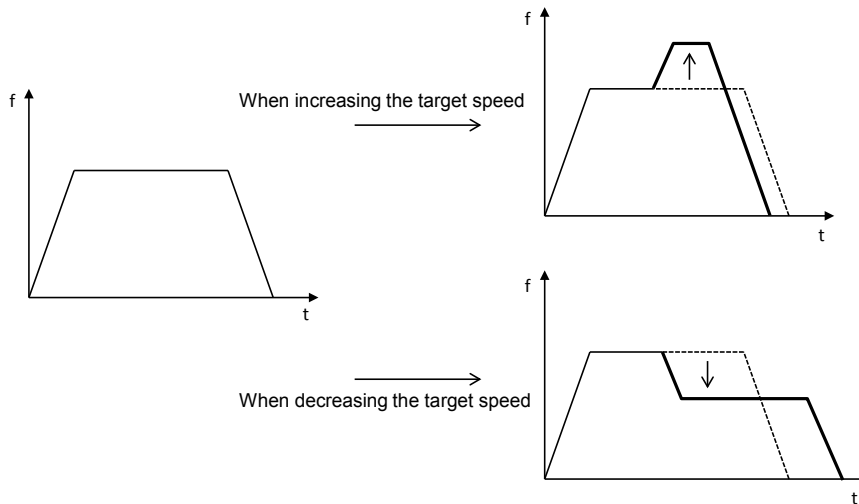

■ Use Conditions

The use conditions of the target speed change function are as follows.

A: Available, N/A: Not available

Control method	Single axis control	A	<ul style="list-style-type: none"> In the case of the synchronous control, the speed can be changed only for the master axis. (Slave axes operate according to the master axis.)
	Interpolation control	N/A	
	Synchronous control	A	
Operation pattern	E point	A	<ul style="list-style-type: none"> The speed can be changed more than once in one table. The speed cannot be changed during the deceleration in accordance with the stop operation.
	P point	A	
	C point	A	
	J point	N/A	<ul style="list-style-type: none"> The speed cannot be changed during the deceleration in the C point control. The speed cannot be changed during the dwell time in the C point control. For the J point control, use "J point speed change contact" to change the speed. For the JOG operation, change "JOG operation target speed" directly to change the speed.
	JOG operation	N/A	
	Repeat control	A	

■ Speed change method

Speed direct specification	<p>This is a method in which a desired speed is specified directly and the change is requested by I/O.</p> <p>The valid range of the function can be selected from two patterns, which are "Active table only" and "Active table to completion of operation".</p>
Ratio specification (Override)	<p>This is a function to change a set speed using a specified ratio (%).</p> <p>The change request by I/O is not necessary, and the change is reflected when the set value (ratio) is changed.</p> <p>The function is valid for all the positioning operations after the set timing.</p> <p>The ratio specification also becomes valid when the speed is changed by the speed direct specification.</p>

13.8.2 Setting Procedures and Operations (Speed Direct Specification Method)

■ Setting procedures and operations of speed direct specification method

The target speed change function in the speed direct specification method is activated by the following procedure during a positioning operation.

1. Set "Change mode selection" and "Change speed" in the shared memory.
 2. Turn on the "Speed change request" contact during a positioning operation.
- * "Speed change reception annunciation" turns ON when the speed change is actually started.
 * Once the "Speed change request" contact turns OFF, the "Speed change reception annunciation" also turns OFF.

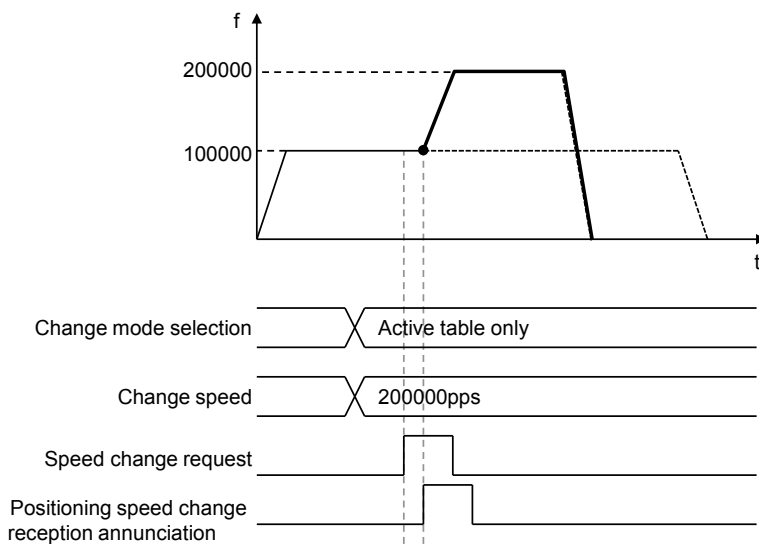

(Note 1) The acceleration time to the change speed and the deceleration time from the change speed follows the setting values of the active table.

(Note 2) The movement amount does not change when the speed change is performed.

■ Setting parameters of speed direct specification method

The following parameters are used in the target speed change function of the speed direction specification method.

Positioning operation change setting area

Unit memory No. (Hex)	Name	Default	Description
UM17C01	Positioning speed change Change mode selection	H0	Area for setting the range of the positioning speed change. 0000H: Active table only 0001H: Active table to E point table (until the completion of the operation) In the case of other values, the unit operates as the setting of 0000H (Active table only).
UM17C11			
UM17C21			
UM17C31			
UM17C71			
UM17C02 UM17C03 UM17C12 - UM17C13 UM17C22 - UM17C23 UM17C32 - UM17C33 UM17C72 - UM17C73	Positioning speed change Change speed	K100	Area for setting a change speed for changing the positioning speed. Set using unit system conversion values. 1 to 32,767,000 (Specified unit system)

(Note): The unit memory numbers in the above table are for the axis 1, axis 2, axis 3, axis 4 and virtual axis from the top.

13.8 Target Speed Change Function (For unit version Ver.1.3 or later only)

■ Example of operation (1) Speed direct specification, Active table only

Parameter	Setting value
Change mode selection	0000H (Active table only)
Change speed	150,000 (pps)

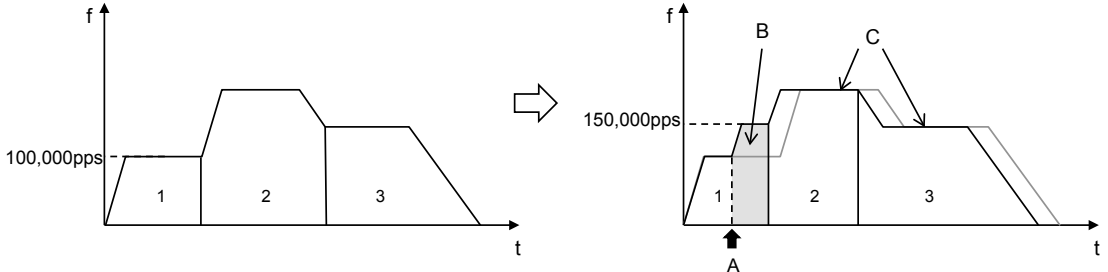

A	Speed change request contact turns ON.
B	Only the speed of the table 1 is changed to 150,000 pps.
C	The speeds of the table 2 and 3 do not change.

■ Example of operation (2) Speed direct specification, Active table to E point table (until the completion of the operation)

Parameter	Setting value
Change mode selection	0001H (Active table to E point table)
Change speed	150,000 (pps)

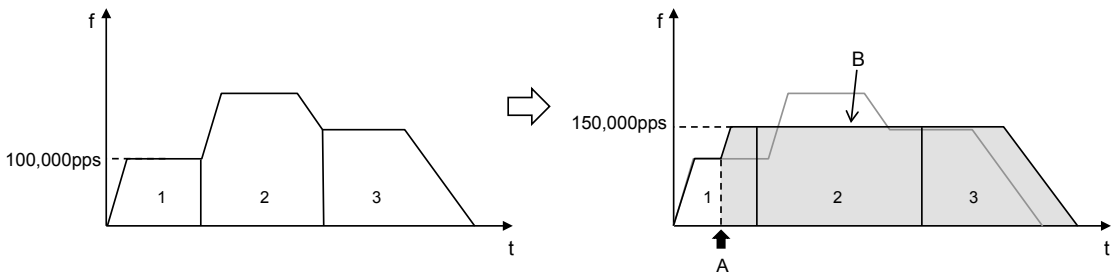

A	Speed change request contact turns ON.
B	The speeds of all consecutive tables are changed to 150,000 pps.

■ Example of operation (For repetitive operations)

When the speed change (speed direct specification, active table only) is performed during the positioning repeat operation, only the speed of the active table in an active repeat period is changed.

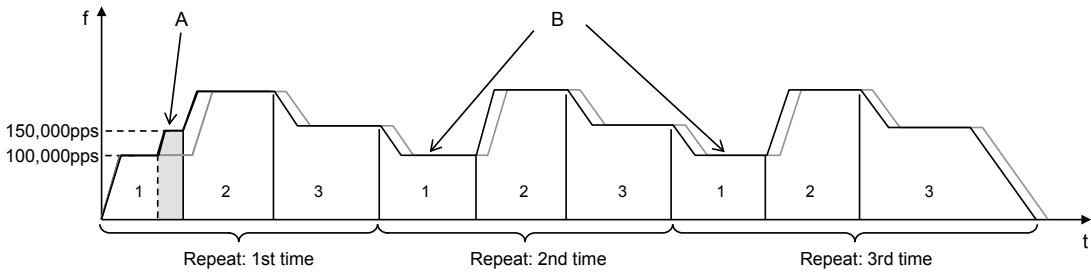
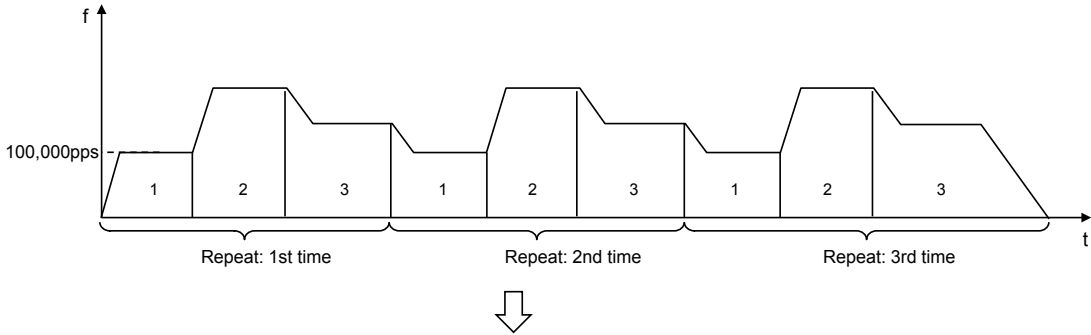

A	Only the speed of the table 1 in the first repeat period is changed to 150,000 pps.
B	The speeds of the table 1 in the second and third repeat periods are not changed.

13.8.3 Setting Procedures and Operations (Ratio Specification Method)

■ Setting procedures and operations of ratio specification method (Override)

When setting the ratio specification, the command speed is immediately reflected in the specified ratio once the "Ratio specification" in the shared memory is changed.

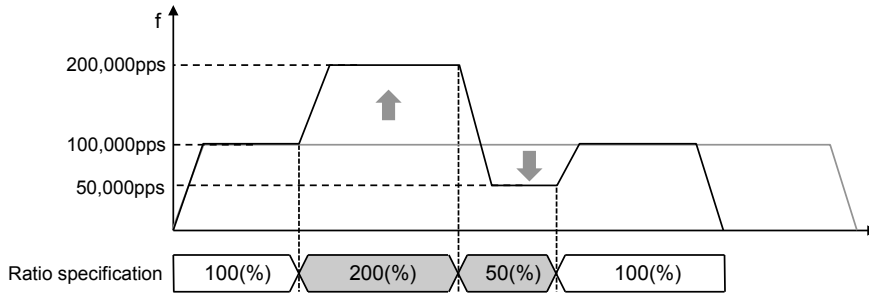

(Note 1) The acceleration time to the change speed and the deceleration time from the change speed follows the setting values of the active table.

(Note 2) The movement amount does not change when the speed change is performed.

■ Setting parameters of ratio specification method

The following parameters are used in the target speed change function of the ratio specification method.

Positioning operation change setting area

Unit memory No. (Hex)	Name	Default	Description
UM17C00	Positioning speed change Ratio specification (Override)	K100	Area for setting the change ratio (override) to the command speed for the positioning speed change. The speed change request by I/O is not necessary, and the change becomes valid when the set value (ratio) is set. 1 to 300 (%)
UM17C10			
UM17C20			
UM17C30			
UM17C70			

(Note) : The unit memory numbers in the above table are for the axis 1, axis 2, axis 3, axis 4 and virtual axis from the top.

■ Example of Operation

When changing the ratio from 100% to 150%

Parameter	Setting value
Ratio specification	100 (%) to 150 (%)

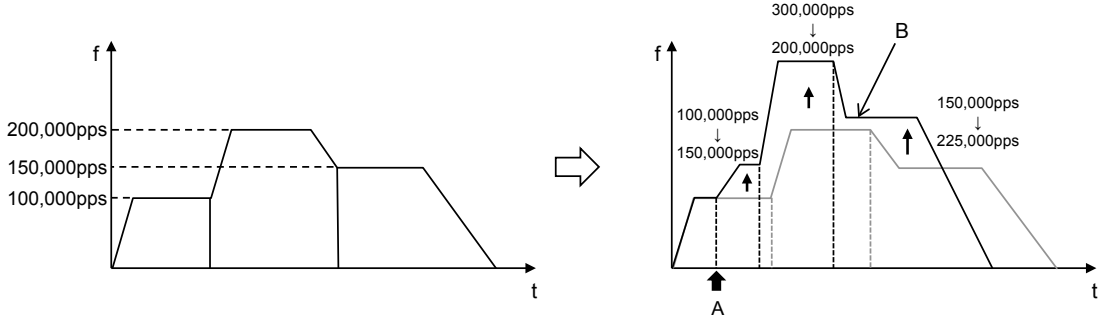

A	The ratio specification is changed from 100 to 150 (%).
B	All consecutive tables follow the set ratio.

13.9 Movement Amount Change Function (For unit version Ver.1.3 or later only)

13.9.1 Function Explanation

- The movement amount change function is used to change the movement amount on an active positioning table to an arbitrary amount.
- Even when the movement amount is changed, the target speed is the same.

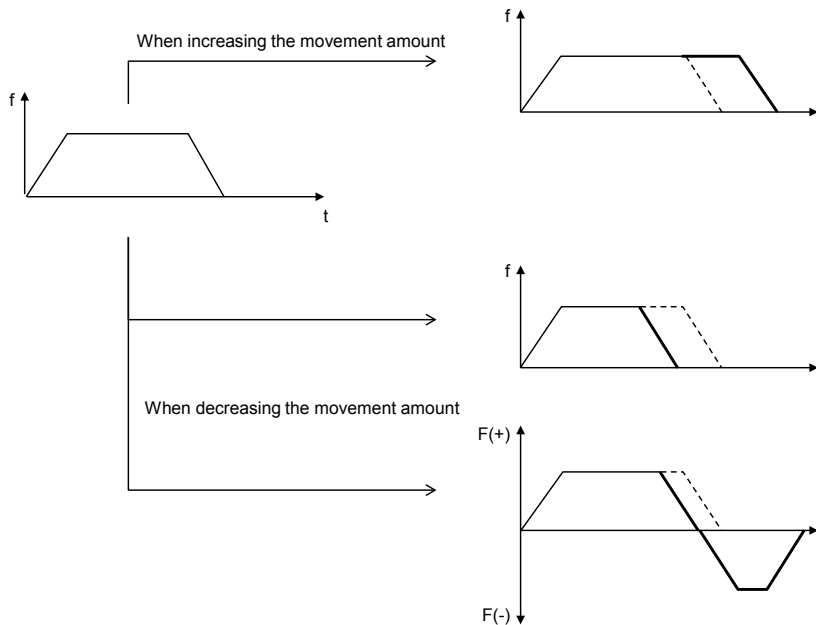

■ Use Conditions

The use conditions of the movement amount change function are as follows.

A: Available, N/A: Not available

Control method	Single axis control	A	• In the case of the synchronous control, the movement amount can be changed only for the master axis. (Slave axes operate according to the master axis.)
	Interpolation control	N/A	
	Synchronous control	A	
Operation pattern	E point	A	• The movement amount can be changed more than once in one table.
	P point	A	
	C point	A	• The movement amount cannot be changed during the deceleration in accordance with the stop operation.
	J point	N/A	
	JOG operation	N/A	• The movement amount cannot be changed during the deceleration in the C point control.
	Repeat control	A	

13.9.2 Setting Procedures and Operations

■ Setting procedures and operations of movement amount change function

The movement amount change function is activated by the following procedure during a positioning operation.

1. Set "Change movement amount" in the shared memory.
2. Turn on the "Movement amount change request" contact during a positioning operation.

* "Movement amount change reception annunciation" turns ON when the movement amount change is actually started.

* Once the "Speed change request" contact turns OFF, the "Speed change reception annunciation" also turns OFF.

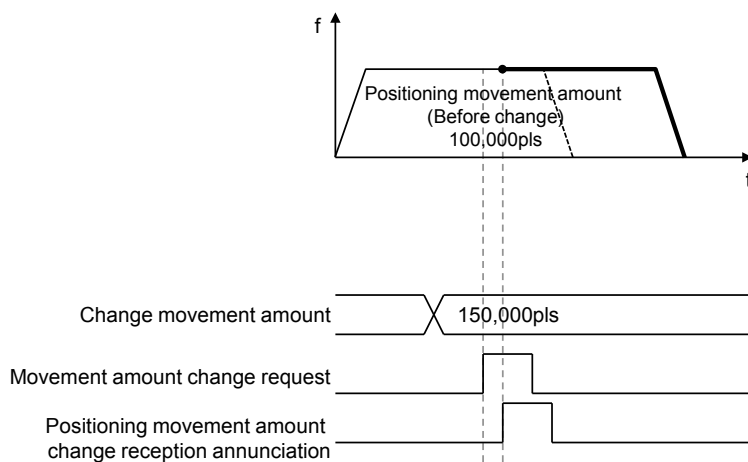

■ Setting parameters

The following parameters are used in the movement amount change function.

Positioning operation change setting area

Unit memory No. (Hex)	Name	Default	Description
UM17C0A - UM17C0B	Positioning movement amount change Change movement amount	H0	Area for setting a change movement amount for changing the positioning movement amount. -1,073,741,823 to 1,073,741,823 (Specified unit system)
UM17C1A - UM17C1B			
UM17C2A - UM17C2B			
UM17C3A - UM17C3B			
UM17C7A - UM17C7B			

(Note): The unit memory numbers in the above table are for the axis 1, axis 2, axis 3, axis 4 and virtual axis from the top.

13.9 Movement Amount Change Function (For unit version Ver.1.3 or later only)

■ Example of operation (1) When reducing the movement amount (Change movement amount > Current value)

Parameter	Setting value
Control method	Incremental
Positioning movement amount (Before change)	10,000 (pls)
Positioning movement amount (After change)	7,000 (pls)

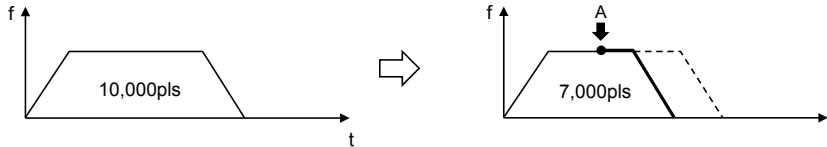

A	Movement amount change request contact ON
---	---

■ Example of operation (2) When reducing the movement amount (Change movement amount < Current value)

Parameter	Setting value
Control method	Incremental
Positioning movement amount (Before change)	10,000 (pls)
Positioning movement amount (After change)	1,000 (pls)

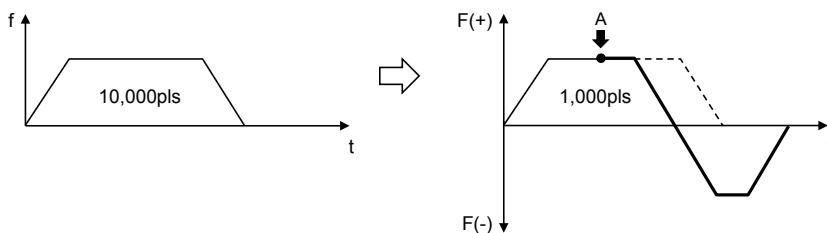

A	Movement amount change request contact ON
---	---

■ Example of operation (3) When a continuous table operation is performed (Incremental)

Parameter	Setting value
Control method	Incremental
First table positioning movement amount (Before change)	5,000 (pls)
First table positioning movement amount (After change)	8,000 (pls)

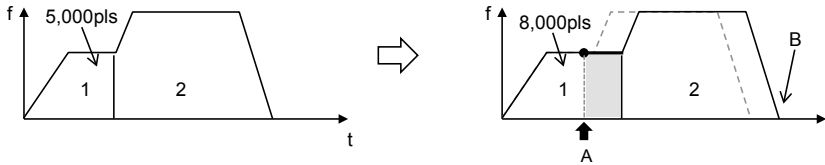

A	Movement amount change request contact ON
B	Because of the increment setting, the stop position of the table 2 also changes.

■ Example of operation (4) When a continuous table operation is performed (Absolute)

Parameter	Setting value
Control method	Absolute
First table positioning movement amount (Before change)	5,000 (pls)
First table positioning movement amount (After change)	8,000 (pls)

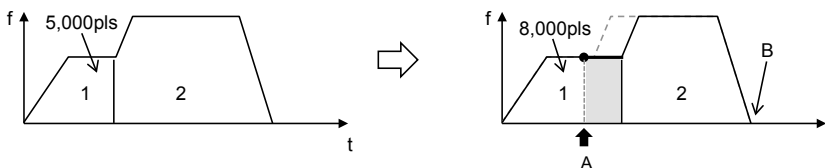

A	Movement amount change request contact ON
B	Because of the absolute setting, the stop position of the table 2 does not change.

13.9 Movement Amount Change Function (For unit version Ver.1.3 or later only)

■ Example of operation (For repetitive operations)

When the movement amount change is performed during the positioning repeat operation, only the movement amount of the active table in an active repeat period is changed.

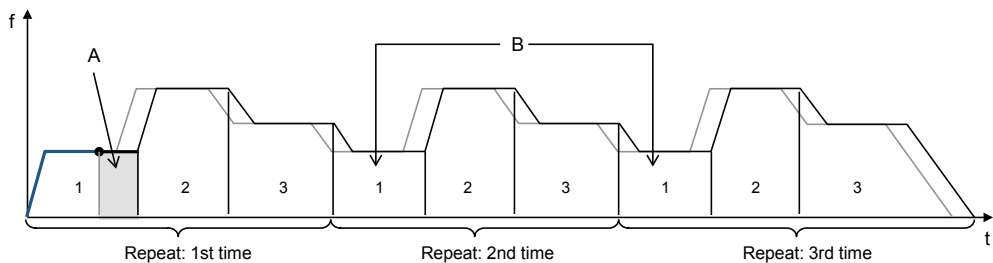
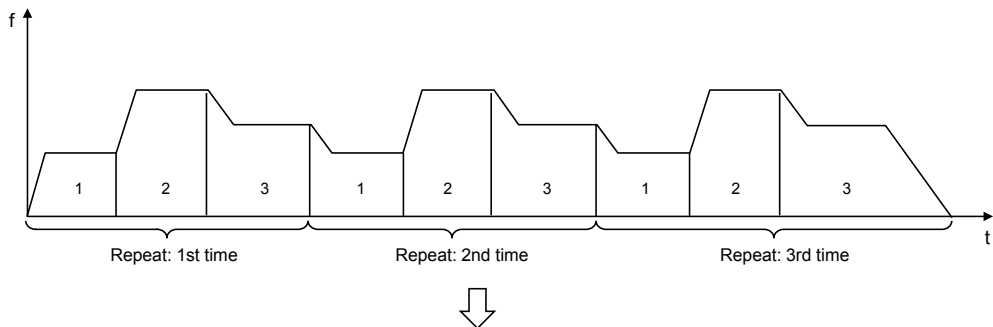

A	Only the movement amount of the table 1 in the first repeat period is changed to 8,000 pls.
B	The movement amounts of the table 1 in the second and third repeat periods are not changed.

■ Auxiliary output when changing movement amounts

Even if the movement amount is changed when the auxiliary output is set in the delay mode, the auxiliary contact turns ON at the position of the delay ratio to the movement amount before the change. If the delay ratio is set to 100%, however, the auxiliary contact turns ON on the completion of the operation.

14

Programming Cautions

14.1 Programming Cautions

14.1.1 Turning Off Power Supply Clears Contents of Unit Memory

The unit memory data of the positioning unit will be cleared when the PLC is turned off.

14.1.2 Not Going to Other Operation from Current Operation

Automatic operation (positioning control) or manual operation (JOG operation, home return, or pulser operation) that has started with the start contact turned ON will continue even if the contact of other operation turns ON.

However, the stop operation (deceleration stop, emergency stop, system stop) can be executed during other types of operation.

14.1.3 Operation with the PLC Set to PROG. Mode from RUN Mode

Automatic operation (positioning control) or manual operation (JOG operation, home return, or pulser operation) that has started with the start contact turned ON will continue even if the PLC is switched to PROG. mode from RUN mode.

14.1.4 Types of Positioning Data Setting Areas

The positioning unit has a standard 600-point positioning data setting area and 25-point extended area with the following characteristics. There are a standard area and an expansion area in the positioning data setting area, and they have the following characteristics. Use either of them according to the application.

■ Comparison of standard area and expansion area

Items	Standard area	Extended area
No. of positioning data tables	600 tables	25 tables +75 tables (Note 3)
Table number	1 to 600	10001 to 10100 (Note 3)
Positioning parameter settings on Configurator PM7 (note 1)	Available	Available
Positioning data settings on Configurator PM7 (note 2)	Available Data that has been set is downloaded along with other project data including the program to the CPU unit. Positioning data will be calculated and each type of operation will be ready to start when the power is turned on or the CPU unit is set to RUN mode.	Not available
Positioning data setting with user program (note 2)	Available Each type of operation will be ready to start after the data is transferred to the unit memory (UM) area with the user program and a recalculation request is made.	Available Each type of operation will be ready to start after the data is transferred to the unit memory (UM) area with the user program. No recalculation request is required.
Characteristics	In the case of setting positioning data with the Configurator PM7, the start will be quicker than that with the extended area used.	In the case of setting positioning data with a user program, the start will be quicker than that with the standard area used.
Application	Suitable to applications where the movement amount, target speed, and other positioning data are determined.	This is suitable for cases where positioning data fluctuates according to the operation results of the PLC.

(Note 1): Positioning parameters refer to operating conditions, such as the JOG operation and home return conditions along with the limit input logic, and deceleration stop time.

(Note 2): Positioning data refers to the individual positioning information such as the movement amount, target speed, acceleration and deceleration time, and operating pattern data, and other individual positioning information.

(Note 3): Table numbers 10026 to 10100 are available for the unit Ver.1.5 or later.

■ Calculation of reconstructing of standard area

The calculation of reconstruction (recalculation) will be required if the standard positioning data area is overwritten with a user program. If the data is not recalculated after rewriting the positioning table by the program, note that the operation will be executed with the previous positioning table. The recalculation procedure is as follows:

1. Change the positioning table in the unit memory.
2. Turn ON the recalculation request signal (Y7) in the I/O area.
3. Check that the recalculation completion signal (X7) in the I/O area turns ON, and start a desired type of operation.

(Note) The I/O numbers of the recalculation request signal (Y7) and the recalculation completion signal (X7) vary with the first word number allocated to the unit.



◆ REFERENCE

For the difference in programming method between the standard area and extended area, refer to Section 18 Sample program.

■ Unit memories of expansion areas

- In the expansion area, there are two areas, which are an expansion area 1 (for table numbers 10001 to 10025) and an expansion area 2 (for table numbers 10026 to 10100).
- The expansion area 2 (for table numbers 10026 to 10100) is available for the unit Ver.1.5 or later.

Expansion area 1

Table no.	1st axis	2nd axis	3rd axis	4th axis	Virtual axis
10001	UM 02E70	UM 05670	UM 07E70	UM 0A670	UM 14670
10002	UM 02E80	UM 05680	UM 07E80	UM 0A680	UM 14680
-	-	-	-	-	-
-	-	-	-	-	-
10024	UM 02FE0	UM 057E0	UM 07FE0	UM 0A7E0	UM 147E0
10025	UM 02FF0	UM 057F0	UM 07FF0	UM 0A7F0	UM 147F0

Expansion area 2

Table no.	1st axis	2nd axis	3rd axis	4th axis	Virtual axis
10026	UM 0A850	UM 0AD00	UM 0B1B0	UM 0B660	UM 0C920
10027	UM 0A860	UM 0AD10	UM 0B1C0	UM 0B670	UM 0C930
-	-	-	-	-	-
-	-	-	-	-	-
10099	UM 0ACE0	UM 0B190	UM 0B640	UM 0BAF0	UM 0CDB0
10100	UM 0ACF0	UM 0B1A0	UM 0B650	UM 0BB00	UM 0CDC0



◆ KEY POINTS

- There are two areas in the expansion area of positioning table. It is recommended to select an area with consecutive UM numbers according to the number of used tables.

Number of necessary tables	Area and table numbers to be used
1 to 25	Expansion area 1: Table numbers 10001 to 10025
26 to 75	Expansion area 2: Table numbers 10026 to 10100
76 to 100	Both the expansion areas 1 and 2 are used.



◆ REFERENCE

- For details of unit memory (UM) numbers in the expansion area, refer to "17.6.3 Positioning Data Setting Areas".
- For details of the difference in program methods between the standard area and expansion area, refer to Sample program in Chapter 18.

15

Errors and Warnings

15.1 About Errors and Warnings

15.1.1 Errors and Warnings

If any operational unconformity occurs in the positioning unit, an error or warning will occur. When an error or warning occurs, the following operation will be performed.

Errors	Occurs in any abnormal conditions. When a motor is operating, the operation stops. The motor stopped due to the occurrence of error will not be activated until the error clear is executed.
Warnings	Occurs if there is any operational unconformity but not abnormal. The operation can continue even after the occurrence of warnings, and the motor continues running if the motor is operating.

15.1.2 Check and Clearing with Configurator PM7

It is possible to check and clear data on an axis-by-axis basis by selecting [Online] → [Data monitor] on the Configurator PM7 programming tool.

Axis [Group]	Virtual axis	1 axis	2 axis	3 axis	4 axis
Synchronous master axis	Master	-----	Virtual axis	-----	-----
Synchronized output	-----	Cam	-----	-----	-----
Synchronous state	Synchronous	Asynchronous	Synchronous	Asynchronous	Asynchronous
Table number executing	1	0	0	0	0
Auxiliary output code	0	0	0	0	0
Current value	0	0	1887122	0	-82820
Unit conversion current value	0 pulse	0 pulse	1887122 pulse	0 pulse	-82820 pulse
Pulse input value	-----	0	0	0	0
Deviation	-----	0	0	0	0
Axis state	Stopped	Error	Error	Stopped	Stopped
Error code	-----	00000-E3012	00000-E3043	-----	-----
	Clear errors	Clear errors	Clear errors	Clear errors	Clear errors
Warning code	-----	-----	-----	-----	-----
	Clear warning	Clear warning	Clear warning	Clear warning	Clear warning

15.1.3 Check and Clearing with User Program

■ Check on error and warning information

- Use the dedicated command PERED (to get errors and warnings) and read information.

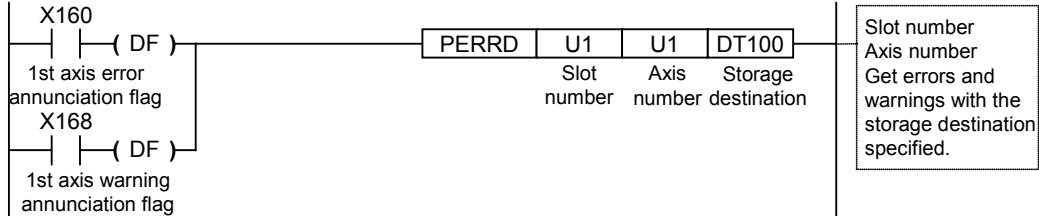

Error and warning codes are stored as shown below.

DT100	Error code
DT101	Warning code

■ Clearing all axes with UCLR command

- When the dedicated UCLR command (to clear errors and warnings), the errors and warnings on all the axes of the positioning unit will be cleared.



■ Clearing each axis by I/O signals

- It is possible to clear errors and warnings on an axis-by-axis basis by turning ON the error/warning clear request flags allocated to the I/O area. The following program shows the clearing of errors on each axis.

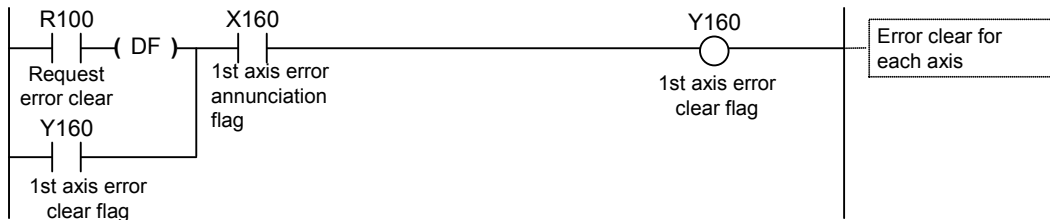

■ I/O signal allocation

Signal name	1st axis	2nd axis	3rd axis	4th axis	Virtual axis
Error annunciation	X60	X61	X62	X63	X67
Warning annunciation	X68	X69	X6A	X6B	X6F
Request error clear	Y60	Y61	Y62	Y63	Y67
Request warning clear	Y68	Y69	Y6A	Y6B	Y6F

(Note 1): The I/O numbers in the above table show relative addresses based on the base word number. I/O numbers actually used vary with the number of the slot where the unit is installed and the first word number.

15.1.4 Error and Warning Logs

There are log areas to store the error/warning logs within the positioning unit.

Error log	Up to 7 error codes can be stored for each axis.
Warnings log	Up to 7 warning codes can be stored for each axis.

- Once an error/warning occurs, the error/warning code will be stored in the log area of the axis causing the error.
- When an error/warning that is not related to axes occurs, such as a failure in the unit, the error/warning code will be stored in the log areas of all the axes.
- The positioning setting menu of the programming tool makes it possible to check only the latest error and warning codes on each axis.
- When referring the error and warning logs for each axis, read the following memory from the PLC.

Error log area (unit memory)

Warning log area (unit memory)

UM 00128 ~ UM 00137	Error log area of axis 1	UM 00128	—
UM 00138 ~ UM 00147	Error log area of axis 2	UM 00129	No. of occurrences of errors
UM 00148 ~ UM 00157	Error log area of axis 3	UM 0012A	Error code annunciation buffer 1
UM 00158 ~ UM 00167	Error log area of axis 4	UM 0012B	Error code annunciation buffer 2
UM 00198 ~ UM 001A7	Error log area of virtual axis	UM 0012C	Error code annunciation buffer 3
		UM 0012D	Error code annunciation buffer 4
		UM 0012E	Error code annunciation buffer 5
		UM 0012F	Error code annunciation buffer 6
		UM 00130	Error code annunciation buffer 7
		UM 00131	
		UM 00132	
		UM 00133	
		UM 00134	
		UM 00135	
		UM 00136	
		UM 00137	

UM 001C0 ~ UM 001CF	Warning log area of axis 1	UM 001C0	—
UM 001D0 ~ UM 001DF	Warning log area of axis 2	UM 001C1	No. of occurrences of warnings
UM 001E0 ~ UM 001EF	Warning log area of axis 3	UM 001C2	Warning code annunciation buffer 1
UM 001F0 ~ UM 001FF	Warning log area of axis 4	UM 001C3	Warning code annunciation buffer 2
UM 00230 ~ UM 0023F	Warning log area of virtual axis	UM 001C4	Warning code annunciation buffer 3
		UM 001C5	Warning code annunciation buffer 4
		UM 001C6	Warning code annunciation buffer 5
		UM 001C7	Warning code annunciation buffer 6
		UM 001C8	Warning code annunciation buffer 7
		UM 001C9	
		UM 001CA	
		UM 001CB	
		UM 001CC	
		UM 001CD	
		UM 001CE	
		UM 001CF	

Number of occurrences of errors/warnings	Stores the number of occurrences of errors and warnings.
Error/warning annunciation buffers	Stores error and warning codes. Errors and warnings are stored in chronological order beginning with buffer 1, followed by buffer 2, 3, etc.

15.2 Changes in Recovery from Errors

15.2.1 Outline

The method to recover from error occurrence varies according to the states when errors occur.

Status if an error occurs	Description	Error type
Recoverable state (Yes)	<ul style="list-style-type: none">• After an error occurs, the operating axes stop.• After an error occurs, the Positioning Unit can recover from the error at any timing.	All errors Type
Unrecoverable state (No)	<ul style="list-style-type: none">• A critical error on the positioning unit system• If an unrecoverable error occurs, the power supply of the positioning unit should be turned off and on.	System Error Axis operation error

15.3 Error Code Table

15.3.1 System Error (from 1000H)

These are the errors that occur due to any failure within the positioning unit. The system errors are defined as fatal errors for the system. Except for some items, the power supply must be turned off and on again to recover from the errors.

Error code	Error name	Description	Object	Recovered	Countermeasures
1000H	System runaway	System runaway If the error occurs, the ALARM LED on the positioning unit will be lit.	All axes	No	Turn off the power supply and turn it on again. If an error occurs repeatedly, consult your Panasonic representative.
1001H	Hardware error	An error has occurred in a hardware test with the power supply turned on.	All axes	No	
1002H	Unit error	Any error has occurred in the internal processing.	All axes	No	
1003H	System processing error	An error has occurred in the system processing due to some reason.	All axes	Yes	Check the settings. If an error occurs repeatedly with the correct set values, consult your Panasonic representative.
1020H	Tool operation abnormal end	An error in communication with the PC has occurred while operating the programming tool with the positioning setting menu.	All axes	Yes	Check the connection of the cable connecting the PC and PLC. Reboot the PC.
1030H	CPU unit error	An alarm has occurred to the CPU unit.	All axes	No	Check the condition of the CPU unit. Turn off the power supply and turn it on again.
1031H	CPU unit operation mode error	The system in operation has come to a stop because the CPU unit is switched to PROG. Mode.	All axes	Yes	Check the condition of the CPU unit. Set the CPU unit to RUN Mode.

15.3.2 Axis operation error (from 3000H)

These are the errors that will occur while various operations are being executed.

Error code	Error name	Description	Object	Recovered	Countermeasures
3010H	Limit + signal detection	The input on the positive side of the limit has turned ON.	Each axis	Yes	Move the motor into the range of the limit by an appropriate mode, such as JOG operation. Check the limit signal is correct.
3011H	Limit – signal detection	The input on the negative side of the limit has turned ON.	Each axis	Yes	
3012H	Limit signal error	Both inputs on the positive and negative sides of the limit have turned ON.	Each axis	Yes	Check the status of the limit signal.
3020H	Software limit (positive side) detection	The movement amount of the motor has exceeded the upper limit of the software limit.	Each axis	Yes	Move the motor into the range of the software limit by an appropriate mode, such as JOG operation. Check the set values of the software limit.
3021H	Software limit (negative side) detection	The movement amount of the motor has exceeded the lower limit of the software limit.	Each axis	Yes	
3025H	Command speed operation error 1	The internal operation of command speed failed due to overflow.	Each axis	Yes	Lower the set speed. Check the settings of the pulse number per rotation and movement amount per rotation.
3026H	Command speed operation error 2		Each axis	Yes	
3027H	Command speed operation error 3		Each axis	Yes	
3030H	Axis operation error	An error has occurred in the operation processing of each axis due to some reason.	Each axis	Yes	Check the set values and parameters for the positioning unit. If an error occurs repeatedly with the correct set values, consult your Panasonic representative.
3031H	Operation abnormal end	An error has occurred in the operation processing of each axis due to some reason.	Each axis All axes	Yes	If an error occurs repeatedly, consult your Panasonic representative.
3032H	Axis group operation error	Axis group settings are changed while the positioning unit is in operation or a stop request is being made. Axis group settings are outside the range.	Each axis	Yes	Changing the axis group should be performed when the axes are not in operation. Do not make a stop request, either. Check the axis group settings.
3033H	Interpolation operation error	The operation has stopped due to an error in another interpolation axis during interpolation.	Each axis	Yes	Check the set values for positioning data on interpolation. If an error occurs repeatedly with the correct set values, consult your Panasonic representative.

Errors and Warnings

Error code	Error name	Description	Object	Recovered	Countermeasures
3034H	Axis group not settable (In pulser operation)	The axis group settings are changed while the positioning unit is in pulser operation.	Each axis	Yes	Changing the axis group should be performed when the pulser operation enabled signal is OFF.
3035H	Positioning movement amount error	The positioning movement amount has exceeded the upper or lower limit.	Each axis	Yes	Check the set value.
3040H	Synchronous operation group error	The synchronous group is changed while the positioning unit is in synchronous operation or a stop request is being made. The settings of axis groups are outside the range. An error has occurred during a home return while the positioning unit is in synchronous operation.	Each axis	Yes	Changing the synchronous group should be performed when the busy signal for the axes to be synchronized is OFF. It should be performed when various stop request signals (system stop, emergency stop, deceleration stop) are OFF.
3042H	Synchronous operation home return error	The home return processing is executed in synchronous operation.	Each axis	Yes	When performing the home return processing, cancel the synchronous control.
3043H	Synchronous operation error	The operation has stopped as an error occurred on another axis while the positioning unit is in synchronous operation.	Each axis	Yes	Check the unit setting of the stopped axis. If an error occurs repeatedly with the correct set values, consult your Panasonic representative.
3044H	Synchronous operation not settable (In pulser operation)	The setting of the synchronous operation was changed while the positioning unit is in pulser operation.	Each axis	Yes	Changing the setting of the synchronous operation should be performed when the pulser operation enabled signal is OFF.
3045H	Synchronous axis difference check error	The difference between the movement amounts of the target axes under synchronous control exceeded the specified difference.	Each axis	Yes	Check the operation of the target axes for the synchronous operation.
3046H	Automatic movement amount check error	The automatic movement amount check function has detected that the difference between the instruction value and feedback value is in excess of the preset automatic movement amount.	Each axis	Yes	Check the operation of the target axes. Check the parameters of the automatic check function of movement amount.

15.3.3 Set Value Error (from 4000H)

The following errors occur to various set values made in the positioning setting menu of the programming tool and ladder programs.

Error code	Error name	Description	Object	Recovered	Countermeasures
4000H	The settings of axis groups are not correct	The settings of axis groups are not correct.	Each axis	Yes	<p>Check the following items in the settings of the axis group and independent axis.</p> <ul style="list-style-type: none"> • The same axis number has been registered in more than one group. • Four or more axes have been set in one group. • The group is composed of one axis only.
4002H	Unit setting error	The unit system for the axis setting is out of the range.	Each axis	Yes	<p>Check if the unit is one of the followings.</p> <p>pulse, μm, inch, degree</p>
4004H	Pulse number error per rotation	The pulse number is out of the range.	Each axis	Yes	<p>Check the set value.</p> <p>If the set value is out of the range, reduce it by the following formula.</p>
4005H	Movement amount error per rotation	The movement amount is out of the range.	Each axis	Yes	<p>(Pulse number per rotation) / (Movement amount per rotation)</p>

Errors and Warnings

Error code	Error name	Description	Object	Recovered	Countermeasures
4010H	Software limit setting error	The upper or lower limit value of software limit is out of the range.	Each axis	Yes	Check the set value. If an error occurs repeatedly with the correct set values, consult your Panasonic representative.
4020H	Limit stop deceleration time error	The limit stop deceleration time is out of the range.	Each axis	Yes	
4021H	Error stop deceleration time error	The error stop deceleration time is out of the range.	Each axis	Yes	
4022H	Emergency stop deceleration time error	The emergency stop deceleration time is out of the range.	Each axis	Yes	
4028H	Auxiliary output setting error	The settings of auxiliary output are not correct. A mode other than With mode or Delay mode for the auxiliary output mode has been set. The auxiliary output delay ratio while the positioning unit is in Delay mode is not 0 to 100 (%).	Each axis	Yes	
4030H	Synchronous group setting error	The same axis has been set for the synchronous groups 1 and 2. Either master axis or slave axis has not been set. Multiple axes have been set for the master or slave axis. The same axis has been set for the master and slave axes. The slave axis has been set to the interpolation group.	Each axis	Yes	
4031H	Synchronous operation mode setting error	Operation settings for the synchronous operation differential check function are incorrect.	Each axis	Yes	Check the set value. If an error occurs repeatedly with the correct set values, consult your Panasonic representative.
4042H	Pulser setting error	The pulser input mode is incorrect. Pulser operation method is incorrect. Pulser operation max. speed is incorrect.	Each axis	Yes	
4043H	Pulse operation disabled error	The pulse input application is not set to pulser for the axis for which pulse input is permitted.	Each axis	Yes	

15.3 Error Code Table

Error code	Error name	Description	Object	Recovered	Countermeasures
4044H	Speed factor error	The setting of the speed factor is out of the range.	Each axis	Yes	Check the set value. If an error occurs repeatedly with the correct set values, consult your Panasonic representative.
4050H	Startup speed error	The startup speed is out of the range.	Each axis	Yes	
4080H	JOG positioning acceleration/deceleration type error	The acceleration/deceleration method of the JOG positioning is out of the range.	Each axis	Yes	
4081H	JOG positioning deceleration time error	The deceleration time of the JOG positioning is out of the range.	Each axis	Yes	
4082H	JOG positioning acceleration time error	The acceleration time of the JOG positioning is out of the range.	Each axis	Yes	
4083H	JOG positioning target speed error	The target speed of the JOG positioning is out of the range.	Each axis	Yes	
4102H	Home return target speed error	The target speed of the home return is out of the range.	Each axis	Yes	
4105H	Home return acceleration time error	The acceleration time of the home return is out of the range.	Each axis	Yes	
4106H	Home return deceleration time error	The deceleration time of the home return is out of the range.	Each axis	Yes	
4107H	Home return setting code error	The home return setting code is incorrect.	Each axis	Yes	
4110H	Home return creep speed error	The creep speed of the home return is out of the range.	Each axis	Yes	
4111H	Home return returning direction error	The moving direction of the home return is incorrect	Each axis	Yes	
4112H	Home return limit error	The limit switch is disabled. (It occurs when the home return method is set to the limit method 1 or 2.)	Each axis	Yes	
4113H	Home return disable error by synchronous setting	The pulse input application for the target axis is set to feedback and the pulse input is set to synchronous master.	Each axis	Yes	
4120H	Coordinate origin error	The coordinate origin is out of the range.	Each axis	Yes	
4201H	JOG operation target speed error	The target speed of the JOG operation is out of the range.	Each axis	Yes	
4203H	JOG operation acceleration/deceleration type error	The acceleration/deceleration type of the JOG operation is incorrect.	Each axis	Yes	
4204H	JOG operation acceleration time error	The acceleration time of the JOG operation is out of the range.	Each axis	Yes	
4205H	JOG operation deceleration time error	The deceleration time of the JOG operation is out of the range.	Each axis	Yes	

Errors and Warnings

Error code	Error name	Description	Object	Recovered	Countermeasures
4250H	Current value update error	The set value of the current value update is out of the range.	Each axis	Yes	Check the set value. If an error occurs repeatedly with the correct set values, consult your Panasonic representative.
4301H	Absolute/incremental setting error	A value other than the absolute/increment is set for the move method.	Each axis	Yes	
4302H	Dwell time error	The set value of the dwell time is out of the range.	Each axis	Yes	
4303H	Positioning starting table No. error	The specified table number is 0, or it exceeds the maximum table number.	Each axis	Yes	
4304H	Table setting error	The last table of the positioning setting tables is not the E point.	Each axis	Yes	
4400H	Positioning movement amount setting error	The movement amount of the positioning operation is out of the range.	Each axis	Yes	
4401H	Positioning acceleration/deceleration type error	The acceleration/deceleration type of the positioning operation is incorrect.	Each axis	Yes	
4402H	Positioning acceleration time error	The acceleration time of the positioning operation is out of the range.	Each axis	Yes	
4403H	Positioning deceleration time error	The deceleration time of the positioning operation is out of the range.	Each axis	Yes	
4404H	Positioning target speed error	The target speed of the positioning operation is out of the range.	Each axis	Yes	
4500H	Interpolation type error	The setting of the interpolation type is incorrect.	Each axis	Yes	
4504H	Circular interpolation not executable	The parameter of the circular interpolation (such as center point or pass point) is incorrect.	Each axis	Yes	
4505H	Spiral interpolation not executable	The error occurred while the positioning unit is in spiral interpolation operation as the set value is incorrect.	Each axis	Yes	

15.3 Error Code Table

Error code	Error name	Description	Object	Recovered	Countermeasures
4600H	Pulse input setting error	The pulse input settings are incorrect.	Each axis	Yes	Check the set value. Check the combination of the input type, input multiplication, and input application.
4605H	Pulse count value change setting error	The set pulse count change value is out of the range.	Each axis	Yes	Check the set value.
4609H	Automatic movement amount check method setting error	The operation of the automatic check function of movement amount is incorrect.	Each axis	Yes	
4610H	Automatic movement amount correction numerator setting error	The automatic movement amount correction numerator is out of the range.	Each axis	Yes	
4611H	Automatic movement amount correction denominator setting error	The automatic movement amount correction denominator is out of the range.	Each axis	Yes	
4613H	Automatic movement amount check interval setting error	The automatic movement amount check interval is out of the range.	Each axis	Yes	

15.3.4 Synchronous Parameter Setting Error (from 5000H)

■ **Synchronous parameter: Common error (from 5000H)**

Error code	Error name	Description	Object	Recovered	Countermeasures
5000H	Synchronous master setting value error	The setting for the synchronous master axis is incorrect. → Setting error (Value is incorrect.) → Own axis setting	Each axis	Yes	Check the set value. If the error occurs repeatedly with the correct set values, consult your Panasonic representative.
5001H	Synchronous master pulse input application error	The pulse input other than "High-speed counter" application was selected when setting the synchronous master axis to pulse input.	Each axis	Yes	
5002H	Synchronous setting disable error	The synchronous setting request was made in the following axis setting . - Its own axis (slave axis) is set as the master of another axis. - The master axis is set as the slave axis of another axis. - Its own axis (slave axis) belongs to the interpolation group.	Each axis	Yes	
5006H	Synchronous slave single deceleration stop deceleration time	The setting for the synchronous slave single deceleration stop time is incorrect.	Each axis	Yes	

■ **Synchronous parameter: Electronic gear related error (from 5100H)**

Error code	Error name	Description	Object	Recovered	Countermeasures
5100H	Electronic gear - Gear ratio numerator setting error	The setting for the gear ratio numerator of the electronic gear is incorrect.	Each axis	Yes	Check the set value. If the error occurs repeatedly with the correct set values, consult your Panasonic representative.
5101H	Electronic gear - Gear ratio denominator setting error	The setting for the gear ratio denominator of the electronic gear is incorrect.	Each axis	Yes	
5102H	Electronic gear - Gear ratio change time setting error	The setting for the gear ratio change time of the electronic gear is incorrect.	Each axis	Yes	

■ Synchronous parameter: Clutch related error (from 5200H)

Error code	Error name	Description	Object	Recovered	Countermeasures
5200H	Clutch - Clutch ON trigger type setting error	The setting for the clutch ON trigger type is incorrect.	Each axis	Yes	Check the set value. If the error occurs repeatedly with the correct set values, consult your Panasonic representative.
5201H	Clutch - Clutch ON edge selection setting error	The setting for the clutch ON edge selection is incorrect.	Each axis	Yes	
5203H	Clutch - Clutch OFF trigger type setting error	The setting for the clutch OFF trigger type is incorrect.	Each axis	Yes	
5204H	Clutch - Clutch OFF edge selection setting error	The setting for the clutch OFF edge selection is incorrect.	Each axis	Yes	
5207H	Clutch - Clutch ON method setting error	The setting for the clutch ON method is incorrect.	Each axis	Yes	
5208H	Clutch - Clutch ON slip method setting error	The setting for the clutch ON slip method is incorrect.	Each axis	Yes	
5209H	Clutch - Clutch ON slip time setting error	The setting for the clutch ON slip time is incorrect.	Each axis	Yes	
5210H	Clutch - Clutch ON slip curve selection setting error	The setting for the clutch ON slip curve is incorrect.	Each axis	Yes	
5211H	Clutch - Clutch OFF method setting error	The setting for the clutch ON method is incorrect.	Each axis	Yes	
5212H	Clutch - Clutch OFF slip method setting error	The setting for the clutch OFF slip method is incorrect.	Each axis	Yes	
5213H	Clutch - Clutch OFF slip time setting error	The setting for the clutch OFF slip time is incorrect.	Each axis	Yes	
5214H	Clutch - Clutch OFF slip curve selection setting error	The setting for the clutch OFF slip curve is incorrect.	Each axis	Yes	

Errors and Warnings

■ Synchronous parameter: Electronic cam related error (from 5300H)

Error code	Error name	Description	Object	Recovered	Countermeasures
5300H	Electronic cam - Cam control synchronous master axis cycle setting error	The setting for the cam control synchronous master axis cycle is incorrect.	Each axis	Yes	Check the set value. If the error occurs repeatedly with the correct set values, consult your Panasonic representative.
5301H	Electronic cam - Used cam pattern no. setting error	The used cam pattern number is out of the range. The used cam pattern number is not registered.	Each axis	Yes	
5302H	Electronic cam - Cam stroke amount setting error	The setting for the cam stroke amount is incorrect.	Each axis	Yes	

■ Cam pattern related error (from 5400H)

Error code	Error name	Description	Object	Recovered	Countermeasures
5400H	Cam pattern resolution setting error	The setting for the cam pattern resolution is out of the range.	Each axis	Yes	Check the set value. If the error occurs repeatedly with the correct set values, consult your Panasonic representative.
5401H	Cam pattern set number setting error	The cam pattern set number is out of the range.	Each axis	Yes	
5402H	Cam pattern section function setting error	The setting for the cam pattern section function is out of the range.	Each axis	Yes	
5403H	Cam pattern control start position setting error	The setting for the cam pattern control start position is out of the range.	Each axis	Yes	
5404H	Cam pattern start phase setting error	The start phase setting for each section of cam pattern is out of the range.	Each axis	Yes	
5405H	Cam pattern displacement setting error	The displacement for each section of cam pattern is out of the range.	Each axis	Yes	
5406H	Cam pattern cam curve no. setting error	The curve number for each section of cam pattern is out of the range.	Each axis	Yes	
5410H	Adjustment data total no. setting error	The total number of cam pattern adjustment data is out of the range.	Each axis	Yes	
5411H	Adjustment data no. setting error	The number of cam pattern adjustment data is out of the range. (cam pattern unit)	Each axis	Yes	
5413H	Adjustment data control point setting error	The control point of cam pattern adjustment data is out of the range.	Each axis	Yes	
5414H	Out-of-range adjustment data setting error	The adjustment value of cam pattern adjustment data is out of the range.	Each axis	Yes	

15.4 List of Warning Codes

15.4.1 Unit Warning (from B000H)

These are the warning codes to be given when the warnings occurred in the positioning unit.

Error code	Error name	Description	Object	Recovered	Countermeasures
B000H	Tool operation	<p>The following request signals were turned ON by the host PLC while the positioning unit is in tool operation.</p> <ul style="list-style-type: none"> • Positioning start request flag (each axis) • Home return request flag (each axis) • JOG forward/reverse rotation request flag (each axis) 	Each axis	Yes	<p>No requests from the PLC can be executed while the positioning unit is in tool operation.</p> <p>The following requests, however, can be executed from the PLC while the positioning unit is in tool operation.</p> <ul style="list-style-type: none"> • Deceleration stop request flag (each axis) • Emergency stop request flag (each axis) • System stop request flag (all axes) • Pulser operation enabled flag (each axis)
B010H	Duplicate start	<p>The same axis was requested to start even though the axis operation has not completed.</p>	Each axis	Yes	<p>No requests to any axes in operation can be executed.</p> <p>The following requests, however, can be executed while the positioning unit is in operation.</p> <ul style="list-style-type: none"> • Deceleration stop request flag (each axis) • Emergency stop request flag (each axis) • System stop request flag (all axes)
B030H	J-point simultaneous start warning	<p>The J-point speed change contact and J-point positioning start contact turn ON simultaneously during the JOG positioning (J-point) operation.</p> <p>The J-point contact are turned ON while the system is accelerating or decelerating the speed</p>	Each axis	Yes	<p>When the both contacts turn ON simultaneously, the J-point positioning start contact will have a priority, and the J-point speed change contact will be ignored.</p> <p>Make settings so that the J-point speed change contact will be turned ON while the positioning unit is in operation at constant speed.</p>

Errors and Warnings

Error code	Error name	Description	Object	Recovered	Countermeasures
B031H	J-point speed change request warning	The J-point speed change contact turned ON when J-point operation is not active.	Each axis	Yes	Check the timing that the J-point speed change request contact turns ON.
B032H	J-point positioning start request warning	The J-point positioning start contact turned ON when J-point operation is not active.	Each axis	Yes	Check the timing that the J-point positioning start contact turns ON.
B045H	Synchronous axis difference check warning	<p>The difference between the movement amounts of the target axes in synchronous operation has exceeded the specified difference threshold.</p> <p>This warning occurs when the synchronous operation mode and synchronous difference check function are set to Warning.</p>	Each axis	Yes	Check the operation of the target axes for the synchronous operation.
B046H	Automatic movement amount check warning	<p>The automatic movement amount check function has detected that the difference between the instruction value and feedback value is in excess of the preset automatic movement amount.</p> <p>This warning occurs when the operation of the automatic check function of movement amount is set to Warning.</p>	Each axis	Yes	Check the operation of the target axes.

15.4 List of Warning Codes

Error code	Error name	Description	Object	Recovered	Countermeasures
B048H	Movement amount automatic check warning 2	<p>The difference between the command value and feedback value exceeded the specified movement amount automatic check value with the movement amount automatic check function.</p> <p>This warning occurs under the following conditions.</p> <ul style="list-style-type: none"> - When the command value and feedback value (pulse input) exceeds the check value when the pulse count value has been changed. - When the command value and feedback value exceeds the check value while home return is not performed. 	Each axis	Yes	Check the operation of the target axes.
B050H	Out-of-range output speed upper limit warning	<p>The output exceeds the upper limit for each model by over 10%.</p> <p>Transistor type: 500 Kpps Line driver type: 4 Mpps</p>	Each axis	Yes	Check the setting for the operation speed of the target axes.
B100H	Synchronous setting change disable warning	The change of the synchronous setting was requested on an operating axis.	Each axis	Yes	Changing the synchronous setting should be performed when the busy signal for the axes to be synchronized is off.
B110H	Cam pattern table reading error warning	The operation for the cam pattern table reading request ended abnormally as an incorrect value was set or the execution condition was not satisfied.	All axes	Yes	<ul style="list-style-type: none"> • Confirm the setting values of the parameters required for reading cam patterns. • Confirm if any axes are in synchronous operation. If any, cancel the synchronous operation and read the cam pattern tables. <p>* The details about the cause of the occurrence of this warning are stored in the "cam pattern reading result" area of unit memories.</p>

Errors and Warnings

Error code	Error name	Description	Object	Recovered	Countermeasures
B1111H	Cam pattern table rewriting error warning	The operation for the cam pattern table rewriting request ended abnormally as an incorrect value was set or the execution condition was not satisfied.	All axes	Yes	<ul style="list-style-type: none">• Confirm the setting values of the parameters required for rewriting cam patterns.• Confirm if any axes are in synchronous operation. If any, cancel the synchronous operation and rewrite the cam pattern tables. * The details about the cause of the occurrence of this warning are stored in the "cam pattern rewriting result" area of unit memories.
B304H	Recalculation error warning	An error has occurred while recalculation processing is in process.	Each axis	Yes	Check the settings for each axis parameter and interpolation group.

16

Troubleshooting

16.1 What to Do If an Error Occurs

16.1.1 Motor is not Rotating or Operating (Pulse Output A and B LEDs are Flashing or Lit)

■ **Solution 1: Servo motor**

Check that the servo input is ON.

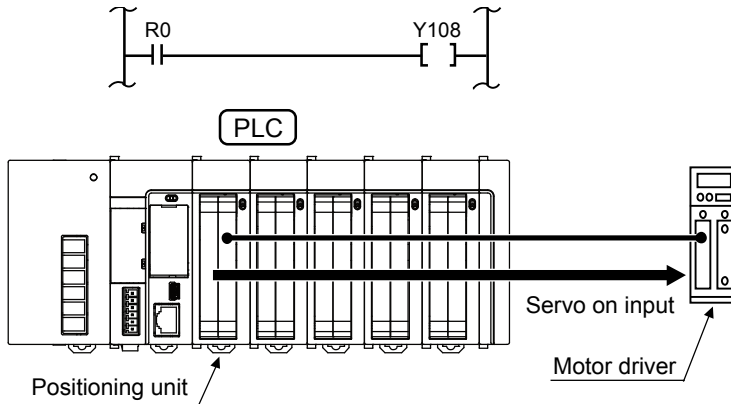

■ **Solution 2**

Check that the power to the driver is turned on.

■ **Solution 3**

Check that the positioning unit and driver are wired correctly.

■ **Solution 4**

Check that the pulse output coincides in setting (CW/CCW or Pulse/Sign setting) with the driver.

16.1.2 Motor is not Rotating or Operating (Pulse Output A and B LEDs are Off)

■ **Solution**

Review the program.

Points of confirmation

1. Check that the I/O numbers are correct.
2. Check that the start contact has not been overwritten in the program.
3. Check the input logic of the over limit switch. (The error LED is lit if the logic is incorrect.)

16.1.3 Reversed Rotation or Movement Direction

[Example of reversed rotation or movement direction]

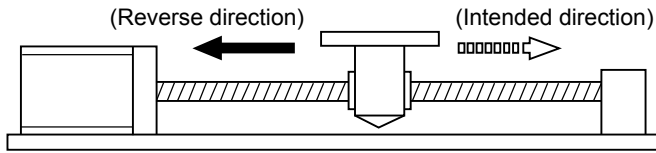

■ Solution 1

Check that the positioning unit and driver are wired correctly.

Points of confirmation

Check that the CW/CCW output or Pulse/Sign output is connected to the corresponding input of the driver.

■ Solution 2

Change the pulse output rotation direction of each axis parameter to set the reversed rotating direction.

17

Specifications

17.1 Specifications

17.1.1 General Specifications

Items	Description
Operating ambient temperature	0°C to +55°C
Storage ambient temperature	-40°C to +70°C
Operating ambient humidity	10% to 95%RH (at 25°C with no-condensing)
Storage ambient humidity	10% to 95%RH (at 25°C with no-condensing)
Breakdown voltage	Each external connector pin and entire power supply terminals of CPU unit 500 V AC for 1 minute
Insulation resistance	Each external connector pin and entire power supply terminals of CPU unit 100 MΩ min. (at 500 V DC)
Vibration resistance	Conforming to JIS B 3502 and IEC 61131-2 5 to 8.4 Hz, 3.5-mm single amplitude 8.4 to 150 Hz, acceleration of 9.8 m/s ² 10 sweeps each in X, Y and Z directions (1 octave/min)
Shock resistance	Conforming to JIS B 3502 and IEC 61131-2 147 m/s ² min in X, Y, and Z directions three times each.
Noise resistance	1,000 V [p-p], pulse width of 50 ns/1 μs (by noise simulator)
Environment	Free from corrosive gases and excessive dust.
EC Directive applicable standard	EMC directive: EN 61131-2
Overvoltage category	Category II or lower
Pollution degree	Pollution degree 2 or lower
Internal current consumption	120 mA or less
Weight	Approx. 145g

Specifications

17.1.2 Performance Specifications

Items		Description					
		2-axis type		4-axis type			
Product no.		AFP7PP02T	AFP7PP02L	AFP7PP04T	AFP7PP04L		
Voltage output type		Transistor	Line driver	Transistor	Line driver		
No. of control axes		2-axis		4-axis			
Interpolation control		2-axis linear interpolation 2-axis circular interpolation		2-axis linear interpolation, 3-axis linear interpolation, 2-axis circular interpolation and 3-axis spiral interpolation			
No. of occupied I/O points		Input: 192 points/Output: 192 points					
Startup speed		3 ms max. in standard area and 5 ms max. in expansion area					
Automatic operation	Positioning control	Position specification method		Increment (specified relative position), Absolute (absolute positioning)			
		Position specified unit		Pulse μm (select a minimum instruction unit of 0.1 μm or 1 μm) inch (select a minimum instruction unit of 0.00001 inch or 0.0001 inch) degree (select a minimum instruction unit of 0.1 degree or 1 degree)			
		Position reference range		Pulse: -1,073,741,823 to +1,073,741,823 pulses μm (0.1 μm): -107,374,182.3 to +107,374,182.3 μm μm (1 μm): -1,073,741,823 to +1,073,741,823 μm inch (0.00001 inch): -10,737.41823 to +10,737.41823 inches inch (0.0001 inch): -107,374.1823 to +107,374.1823 inches degree (0.1 degree): -107,374,182.3 to +107,374,182.3 degrees degree (1 degree): -1,073,741,823 to +1,073,741,823 degrees			
		Speed reference range		Pulse: 1 to 32,767,000 pps μm: 1 to 32,767,000 μm/s inch: 0.001 to 32,767.000 inch/s degree: 0.001 to 32,767.000 rev/s			
		Operation max. speed		500 kpps	4 Mpps	500 kpps	4 Mpps
		Acceleration/deceleration pattern		Linear acceleration/deceleration S-shaped acceleration/deceleration			
		Acceleration time		0 to 10,000 ms (adjustable in 1-ms increments)			
		Deceleration time		0 to 10,000 ms (adjustable in 1-ms increments)			
		No. of positioning tables		Each axis: 600 points in standard area and 25 points in extended area 100 points (Note 1)			
		Control method	Independent		PTP control (E- and C-point control) CP control (P-point control) Speed control (J-point control) JOG positioning control (J-point control)		
			2-axis interpolation	Linear interpolation: E-, P-, C-point control; composite speed or long-axis speed specification			
				Circular interpolation: E-, P-, C-point control; center or passing point specification			
			3-axis interpolation	Linear interpolation: E-, P-, C-point control; composite speed or long-axis speed specification			
		Circular interpolation: E-, P-, C-point control; center or passing point specification					
		Other functions		Dwell time: 0 to 32,767 ms (Settable by 1 ms), auxiliary output contact, auxiliary output code			

(Note 1): From the unit Ver.1.5 or later, the positioning table expansion area has been increased from 25 points to 100 points.

Items			Description		
			2-axis type	4-axis type	
Product no.			AFP7PP02T, AFP7PP02L	AFP7PP04T, AFP7PP04L	
Automatic operation	Synchronous operation	Master axis	Selectable from real axes, virtual axes and pulse inputs.		
		Slave axis	Max. 2 axes	Slave axis	
		Electronic gear	Operation setting	Gear ratio setting	
			Operation method	Direct method, acceleration/deceleration method	
		Electronic clutch	Clutch ON trigger: Contact input		
			Direct method: Direct method, linear slide method		
		Electronic cam	Cam curve	Select from 20 types. Multiple curves can be specified within phase (0 to 100%)	
Resolution	1024, 2048, 4096, 8192, 16384, 32768				
No. of cam patterns	4 to 16 (According to resolution)				
Manual operation	JOG operation	Speed reference range	Pulse: 1 to 32,767,000 pps μm: 1 to 32,767,000 μm/s inch: 0.001 to 32,767.000 inch/s degree: 0.001 to 32,767.000 rev/s		
		Acceleration/deceleration pattern	Linear acceleration/deceleration S-shaped acceleration/deceleration		
		Acceleration time	0 to 10,000 ms (adjustable in 1-ms increments)		
		Deceleration time	0 to 10,000 ms (adjustable in 1-ms increments)		
	Home return	Speed reference range	Pulse: 1 to 32,767,000 pps μm: 1 to 32,767,000 μm/s inch: 0.001 to 32,767.000 inch/s degree: 0.001 to 32,767.000 rev/s		
		Acceleration/deceleration pattern	Linear acceleration/deceleration		
		Acceleration time	0 to 10,000 ms (adjustable in 1-ms increments)		
		Deceleration time	0 to 10,000 ms (adjustable in 1-ms increments)		
		Return method	DOG methods (3 types), limit methods (2 types), data set method, and home position method		
	Pulser operation (Note 2)		Operates in synchronization with pulser input		
	Stop functions	Stop operation type	System stop, emergency stop, limit stop, error stop, deceleration stop, pause		
Stop deceleration time		The system stops when the deceleration time of all axes reaches 0. The deceleration time of emergency stop, limit stop, error stop, deceleration stop and pause is 0 to 10,000 ms. (Settable by 1 ms.)			

Specifications

Items		Description	
		2-axis type	4-axis type
Other specifications	High-speed counter function (Note 2)	Counting range	Counting range -2,147,483,648 to 2,147,483,648 pulses
		Max. counting speed	1 MHz
		Input mode	2-phase (phase difference) input, direction discrimination input, and individual input (with multiplier function for each mode)
			2-point limit inputs, home input, near home input, servo ON output, deviation counter output, software limit function

(Note 2): The pulser operation function and high-speed counter function use the same pulse input terminal. Therefore, the both functions cannot be used simultaneously.

17.2 I/O Number Allocation

The following I/O numbers indicate offset addresses. The I/O numbers actually allocated are based on the first word number allocated to the unit.

Example) If the first word number of the unit is 10, the positioning ready signal will be X100.

Contact allocation	Target axis	Name	Description	
WX0	X0	All axes	Ready announce	Indicates that the unit is ready to operate internally, and announces the start of the system.
	X1	–	–	–
	X2	All axes	Cam table reading completion annunciation	Reads cam tables when the cam table reading request contact (Y2) turns ON. This contact turns ON after the completion of the reading of cam tables.
	X3	All axes	Cam table rewriting completion annunciation	Rewrites cam tables when the cam table rewriting request contact (Y3) turns ON. This contact turns ON after the completion of the rewriting of cam tables.
	X4	All axes	Tool operation in progress	Contact to indicate that the positioning unit is in tool operation. The start from I/O is not available during the Tool operation. A warning will occur if you attempt to do so.
	X5	All axes	Axis group setting done	Makes axis group setting changes in the unit with the axis group setting request contact (Y5) turned ON after making setting changes in the axis group with the program. The contact turns ON upon completion of the setting changes.
	X6	–	–	–
	X7	All axes	Recalculation done	If the recalculation request contact (Y7) turns ON, the positioning data of the unit memory (standard area) will be restructured. This contact will turn ON after restructuring completes. If the recalculation request contact (Y7) turns ON again, this contact will be off once. Note) It is used only when the positioning data has been rewritten by ladder programs.
	X8-XF	–	–	–
WX1	X10	1st axis	Servo lock	Turns ON only if there is servo ON output with servo ON signals (Y8 to YB).
	X11	2nd axis		
	X12	3rd axis		
	X13	4th axis		
	X14-X17	–	–	–
	X18	1st axis	BUSY	Turns ON when the corresponding axis is operating.
	X19	2nd axis		
	X1A	3rd axis		
	X1B	4th axis		
X1C-X1E	–	–	–	
X1F	Virtual axis	BUSY	Turns ON when the virtual axis is operating.	

Specifications

Contact allocation	Target axis	Name	Description	
WX2	X20	1st axis	Operation done Turns on when an operation command for the corresponding axis is completed. Turns ON when the operation for all the tables completed for P-point control and C-point control of the automatic operation. After this contact turns ON, the ON-state will continue until the next control is activated.	
	X21	2nd axis		
	X22	3rd axis		
	X23	4th axis		
	X24- X26	–	–	–
	X27	Virtual axis	Operation done	Turns ON when the operation instruction to the virtual axis is completed.
	X28	1st axis	Home return done Turns ON when the home return operation for the corresponding axis is completed. After this contact turns ON, the ON-state will continue until the next control is activated.	
	X29	2nd axis		
	X2A	3rd axis		
	X2B	4th axis		
	X2C- X2E	–	–	–
X2F	Virtual axis	Home return done	Turns ON when the home return operation for the virtual axis is completed.	
WX3	X30	1st axis	Home position A contact to monitor external home position input signal for the corresponding axis. The input logic can be changed in the parameter-setting menu of the Configurator PM7.	
	X31	2nd axis		
	X32	3rd axis		
	X33	4th axis		
	X34- X37	–	–	–
	X38	1st axis	Near home A contact to monitor external near home position input signal for the corresponding axis. The input logic can be changed in the parameter-setting menu of the Configurator PM7.	
	X39	2nd axis		
	X3A	3rd axis		
	X3B	4th axis		
X3C- X3F	–	–	–	
WX4	X40- X47	–	–	–
	X48	1st axis	Auxiliary contact Turns ON when the corresponding positioning table of the corresponding axis is executed.	
	X49	2nd axis		
	X4A	3rd axis		
	X4B	4th axis		
	X4C- X4E	–	–	–
	X4F	Virtual axis	Auxiliary contact	Turns ON when the corresponding positioning table of the virtual axis is executed.

Contact allocation	Target axis	Name	Description		
WX5	X50	1st axis	Limit +	Monitor contact of the limit + and limit –.	
	X51		Limit -		
	X52	2nd axis	Limit +	Decelerates to stop when the limit input that is on an extension of the operating direction turns ON while the positioning unit is in positioning operation, JOG operation, or pulser operation.	
	X53		Limit -		
	X54	3rd axis	Limit +	The deceleration stop time during the limit input can be changed in the unit memory.	
	X55		Limit -		
	X56	4th axis	Limit +	It will be the contact for the automatic inversion when performing a home return.	
	X57		Limit -		
	X58-X5F	–	–	–	
WX6	X60	1st axis	Error annunciation	Turns ON when an error occurs on the corresponding axis. The contacts of all axes turn ON if all axes have errors. The details of the error can be confirmed in the error annunciation area of the unit memory.	
	X61	2nd axis			
	X62	3rd axis			
	X63	4th axis			
	X64-X66	–	–	–	–
	X67	Virtual axis	Error annunciation	Turns ON when an error occurs on the virtual axis.	
	X68	1st axis	Warning annunciation	Turns ON when a warning occurs on the corresponding axis. The contacts of all axes turn ON if a warning occurs on all axes. The details of the warning can be confirmed in the warning annunciation area of the unit memory.	
	X69	2nd axis			
	X6A	3rd axis			
	X6B	4th axis			
X6C-X6E	–	–	–	–	
X6F	Virtual axis	Warning annunciation	Turns ON when a warning occurs on the virtual axis.		
WX7	X70-X7F	–	–	–	
	WX8	X80	1st axis	Synchronous setting done	Changes synchronous settings in the unit with the synchronous setting request contact (Y80 to Y83) turned ON after changing the settings of synchronous control with the program. The contact turns ON upon completion of the setting changes. This contact turns OFF with the synchronous setting request contact (Y80 to Y83) turned OFF.
X81		2nd axis			
X82		3rd axis			
X83		4th axis			
X84-X87		–	–	–	–
X88		1st axis	Synchronous cancel alarm	Turns ON when the synchronous operation of the positioning unit is canceled with the synchronous setting cancel request contact (Y88 to Y8B) turned ON. The synchronous operation axes cannot be executed if this contact is ON for the axes.	
X89		2nd axis			
X8A		3rd axis			
X8B		4th axis			
X8C-X8F		–	–	–	–

Specifications

Contact allocation	Target axis	Name	Description	
WX9	X90	1st axis	Slave axis gear ratio change annunciation Makes gear ratio changes with the slave axis gear ratio change request contact (Y90 to Y93) The contact for the corresponding axis will turn ON after the gear ratio is changed.	
	X91	2nd axis		
	X92	3rd axis		
	X93	4th axis		
	X94-X97	-	-	-
	X98	1st axis	Slave axis clutch operation annunciation The clutch will start operating when the slave axis clutch ON re-request contact (Y98 to Y9B) or clutch OFF request contacts (Y100 to 103) turn ON. The contact for the corresponding axis will turn ON after completion of the operation of the clutch.	
	X99	2nd axis		
	X9A	3rd axis		
	X9B	4th axis		
	X9C-X9F	-	-	-
WX10	X100-X10F	-	-	
WX11	X110	1st axis	Positioning speed change request reception annunciation Starts the speed change operation when the positioning speed change request contact (Y110 to Y113) turns ON. Contacts for corresponding axes (X110 to X113) will turn ON when he request is accepted.	
	X111	2nd axis		
	X112	3rd axis		
	X113	4th axis		
	X114-X116	-	-	-
	X117	Virtual axis	Positioning speed change request reception annunciation Starts the speed change operation when the positioning speed change request contact (Y117) turns ON. The contact for the corresponding axis (X117) will turn ON when he request is accepted.	
	X118	1st axis	Positioning movement amount change request reception annunciation Starts the movement amount change operation when the positioning movement amount change request contact (Y118 to Y11B) turns ON. Contacts for corresponding axes (X118 to X11B) will turn ON when he request is accepted.	
	X119	2nd axis		
	X11A	3rd axis		
	X11B	4th axis		
	X11C-X11E	-	-	-
X11F	Virtual axis	Positioning movement amount change request reception annunciation Starts the movement amount change operation when the positioning movement amount change request contact (Y11F) turns ON. The contact for the corresponding axis (X11F) will turn ON when he request is accepted.		

Contact allocation	Target axis	Name	Description	
WY0	Y0	All axes	System stop	Contact for requesting the system stop. When it turns ON, all axes will stop at the deceleration time 0.
	Y1	–	–	–
	Y2	All axes	Cam table reading request	Turn ON this signal for reading cam tables. The cam table of a specified cam pattern number will be read when this signal turns ON.
	Y3	All axes	Cam table rewriting request	Turn ON this signal for rewriting cam tables. The cam table of a specified cam pattern number will be rewritten when this signal turns ON.
	Y4	–	–	–
	Y5	All axes	Axis group setting change request	This contact will turn ON after the axis group settings are changed.
	Y6	–	–	–
	Y7	All axes	Request recalculation	Turns ON this signal when each positioning data (standard area) in the unit memory was changed. The positioning data after the table number starting the recalculation specified in the unit memory can be restructured and will be executable by turning ON this signal. When restructuring of the positioning data completes, the recalculation done contact (X7) will turn ON. Note) It is used only when the positioning data has been rewritten by ladder programs.
	Y8	1st axis	Servo ON	The servo ON signal for the corresponding axis turns ON at the ON edge of this contact. The servo ON signal will not turn OFF automatically while the positioning unit is in program mode. To turn OFF the servo ON signal, turn ON the servo OFF request (Y50 to Y53). (The operation is the edge type.)
	Y9	2nd axis		
	YA	3rd axis		
YB	4th axis			
YC- YF	–	–	–	
WY1	Y10	1st axis	Positioning start	Requests the positioning control of the corresponding axis. The starting table is specified in the area for specifying the positioning control starting table number in the unit memory. (The operation is the edge type.) If this contact turns ON while the positioning unit is in tool operation, a warning will be output.
	Y11	2nd axis		
	Y12	3rd axis		
	Y13	4th axis		
	Y14- Y16	–	–	–
	Y17	Virtual axis	Positioning start	Requests the positioning control of the virtual axis.
	Y18	1st axis	Home return start	Requests the home return of the corresponding axis. (The operation is the edge type.) If this contact turns ON while the positioning unit is in tool operation, a warning will be output.
	Y19	2nd axis		
	Y1A	3rd axis		
	Y1B	4th axis		
Y1C- Y1E	–	–	–	
Y1F	Virtual axis	Home return start	Requests the home return of the virtual axis. The home return of the virtual axis is possible only by data setting.	

Specifications

Contact allocation	Target axis	Name	Description	
WY2	Y20	1st axis	JOG forward	
	Y21		JOG reverse	
	Y22	2nd axis	JOG forward	
	Y23		JOG reverse	
	Y24	3rd axis	JOG forward	
	Y25		JOG reverse	
	Y26	4th axis	JOG forward	
	Y27		JOG reverse	
	Y28- Y2E	-	-	-
	Y2E	Virtual axis	JOG forward	
Y2F	JOG reverse			
WY3	Y30	1st axis	Emergency stop Requests the emergency stop of the corresponding axis. (The operation is of level type.) Note) The deviation counter cannot be cleared.	
	Y31	2nd axis		
	Y32	3rd axis		
	Y33	4th axis		
	Y34- Y36	-	-	-
	Y37	Virtual axis	Emergency stop	Requests the emergency stop of the virtual axis.
	Y38	1st axis	Deceleration stop Requests the deceleration stop of the corresponding axis. (The operation is of level type.) Note) The deviation counter cannot be cleared.	
	Y39	2nd axis		
	Y3A	3rd axis		
	Y3B	4th axis		
Y3C- Y3E	-	-	-	
Y3F	Virtual axis	Deceleration stop	Requests the deceleration stop of the virtual axis.	
WY4	Y40	1st axis	Pulser operation enabled Requests the permission for the pulser operation of the corresponding axis. (The operation is of level type.)	
	Y41	2nd axis		
	Y42	3rd axis		
	Y43	4th axis		
	Y44- Y46	-	-	-
	Y47	Virtual axis	Pulser operation enabled	Requests the permission for the pulser operation of the virtual axis.
	Y48	1st axis	J-point speed change contact By turning ON this signal while the positioning unit is in J-point operation, the speed changes to the target speed in the specified acceleration/deceleration time and pattern. (The operation is the edge type.)	
	Y49	2nd axis		
	Y4A	3rd axis		
	Y4B	4th axis		
Y4C- Y4E	-	-	-	
Y4F	Virtual axis	J-point speed change contact	By turning ON this signal while the JOG positioning (J-point) operation is performed for the virtual axis, the speed changes to the target speed in the specified acceleration/deceleration time and pattern.	

Contact allocation	Target axis	Name	Description	
WY5	Y50	1st axis	Servo OFF request Turns OFF the servo ON signal for the corresponding axis. The servo ON signal is turned OFF at the ON edge of this contact. (The operation is the edge type.)	
	Y51	2nd axis		
	Y52	3rd axis		
	Y53	4th axis		
	Y54- Y57	—	—	—
	Y58	1st axis	J-point positioning start The positioning unit will go to the next table processing when this signal turns ON during the JOG (J-point) positioning of the corresponding axis. (The operation is the edge type.)	
	Y59	2nd axis		
	Y5A	3rd axis		
	Y5B	4th axis	—	—
	Y5C- Y5E	—	—	—
	Y5F	Virtual axis	J-point positioning start The positioning unit will go to the next table processing when this signal turns ON during the JOG (J-point) positioning of the virtual axis.	
WY6	Y60	1st axis	Error clear request Requests the error clear of the corresponding axis. The processing to recover from errors is performed and the error logs are cleared by turning ON this signal. Note) Unrecoverable errors cannot be recovered even if this signal turns ON.	
	Y61	2nd axis		
	Y62	3rd axis		
	Y63	4th axis		
	Y64- Y66	—	—	—
	Y67	Virtual axis	Error clear request Requests the error clear of the virtual axis.	
	Y68	1st axis	Request warning clear Requests the warning clear of the corresponding axis. The warning logs are cleared by turning ON this signal.	
	Y69	2nd axis		
	Y6A	3rd axis		
	Y6B	4th axis	—	—
	Y6C- Y6E	—	—	—
Y6F	Virtual axis	Request warning clear Requests the warning clear of the virtual axis.		
WY7	Y70- Y7F	—	—	
WY8	Y80	1st axis	Synchronous setting request This contact will turn ON after the synchronous operation settings are changed. Turn ON this contact for reflecting the setting changes in the synchronous control common area of the unit memory. This flag is an edge trigger.	
	Y81	2nd axis		
	Y82	3rd axis		
	Y83	4th axis		
	Y84- Y87	—	—	—
	Y88	1st axis	Synchronous cancel request Turns ON the contact for the axis to cancel the synchronous operation. The unit will not perform the synchronous operation of the axis for which this contact is ON. Turn ON this contact for canceling the synchronous state temporarily during synchronous control. To make the synchronous state, turn OFF this contact.	
	Y89	2nd axis		
	Y8A	3rd axis		
	Y8B	4th axis		
Y8C- Y8F	—	—	—	

Specifications

Contact allocation	Target axis	Name	Description	
WY9	Y90	1st axis	Slave axis gear ratio change request A gear ratio change is made with the contact for the corresponding axis turned ON while the positioning unit is in synchronous operation. (The operation is the edge type.)	
	Y91	2nd axis		
	Y92	3rd axis		
	Y93	4th axis		
	Y94- Y97	—	—	—
	Y98	1st axis	Slave axis clutch ON request The engagement of the clutch starts by turning ON the contact for the corresponding axis while the positioning unit is in synchronous operation. No axes start unless the clutch is used. (Set the operation to level type, rising edge, or falling edge.)	
	Y99	2nd axis		
	Y9A	3rd axis		
	Y9B	4th axis		
	Y9C- Y9F	—	—	—
WY10	Y100	1st axis	Slave axis clutch OFF request The disengagement of the clutch starts by turning ON the contact for the corresponding axis while the positioning unit is in synchronous operation. No axes start unless the clutch is used. (Set the operation to rising edge or falling edge.) These signals will be disabled while the slave axis clutch ON request signal is set to level type.	
	Y101	2nd axis		
	Y102	3rd axis		
	Y103	4th axis		
	Y104- Y10F	—	—	—
WY11	Y110	1st axis	Positioning speed change request Starts the speed change operation when the positioning speed change request contact (Y110 to Y113) turns ON.	
	Y111	2nd axis		
	Y112	3rd axis		
	Y113	4th axis		
	Y114 -Y116	—	—	—
	Y117	Virtual axis	Positioning speed change request Starts the speed change operation when the positioning speed change request contact (Y117) turns ON.	
	Y118	1st axis	Positioning movement amount change request Starts the movement amount change operation when the positioning movement amount change request contact (Y118 to Y11B) turns ON.	
	Y119	2nd axis		
	Y11A	3rd axis		
	Y11B	4th axis		
Y11C -Y11E	—	—	—	
Y11F	Virtual axis	Positioning movement amount change request Starts the movement amount change operation when the positioning movement amount change request contact (Y11F) turns ON.		

17.3 Entire Configuration of Memory Unit Area

The unit memory is in control of parameter and positioning data set values for the positioning unit.

All set values are set with the programming tool software or a user program.

Area name	Unit memory address	Name of each individual area	
Common area	UM 0000 to UM 003FF	Setting parameter control area	
		Operating speed factor area	
		Axis group setting area	
		Current value update data area	
		Positioning table setting area	
		Positioning control area	
		Error annunciation & clear area	
		Warning annunciation & clear area	
		Pulse count control area	
		Synchronous control monitor area	
		System operation setting area	
Each axis information area (Note)	UM 00400 to UM 007FF	1st axis	Each axis information & monitor area
		2nd axis	Each axis information & monitor area
		3rd axis	Each axis information & monitor area
		4th axis	Each axis information & monitor area
		Virtual axis	Each axis information & monitor area
Each axis setting	UM 00800 to UM 02FFF	1st axis	Parameter setting area
			Positioning data setting area (600 standard points and 25 expansion points)
	UM 03000 to UM 057FF	2nd axis	Parameter setting area
			Positioning data setting area (600 standard points and 25 expansion points)
	UM 05800 to UM 07FFF	3rd axis	Parameter setting area
			Positioning data setting area (600 standard points and 25 expansion points)
	UM 08000 to UM 0A7FF	4th axis	Parameter setting area
			Positioning data setting area (600 standard points and 25 expansion points)
	UM 0A850 to UM 0CFFF	1st axis -4th axis Virtual axis	Positioning data setting area (75 expansion points)
	UM 12000 to UM 147FF	Virtual axis	Parameter setting area
Positioning data setting area (600 standard points and 25 expansion points)			

(Note): Check that the positioning done flag (X0) is turned ON in the case of reading each axis information area with a program.

Specifications

Area name	Unit memory address	Name of each individual area	
Synchronous control setting area	UM 16000 to UM 1606F	1st axis	Synchronous control common setting area
			Electronic gear setting area
			Clutch setting area
			Electronic cam setting area
	UM 16070 to UM 160DF	2nd axis	Synchronous control common setting area
			Electronic gear setting area
			Clutch setting area
			Electronic cam setting area
	UM 160E0 to UM 1614F	3rd axis	Synchronous control common setting area
			Electronic gear setting area
			Clutch setting area
			Electronic cam setting area
UM 16150 to UM 161BF	4th axis	Synchronous control common setting area	
		Electronic gear setting area	
		Clutch setting area	
		Electronic cam setting area	
Positioning operation change setting area	UM 17C00 to UM 17C0F	1st axis	Speed change setting area Movement amount change setting area
	UM 17C10 to UM 17C1F	2nd axis	Speed change setting area Movement amount change setting area
	UM 17C20 to UM 17C2F	3rd axis	Speed change setting area Movement amount change setting area
	UM 17C30 to UM 17C3F	4th axis	Speed change setting area Movement amount change setting area
	UM 17C70 to UM 17C7F	Virtual axis	Speed change setting area
Cam pattern editing area	UM 18000 to UM 1805F	-	Cam pattern setting area Cam pattern reading/rewriting execution confirmation area



NOTE

- Be sure not to execute writing in the reserved area for the system.
- For reading each axis information area with the program, check if the ready positioning flag (X0) turns ON before reading it.

17.4 Details of Common Area in Unit Memory

17.4.1 Common Area Configuration

The common area is allocated to the head of the unit memory to make common settings for each axis.

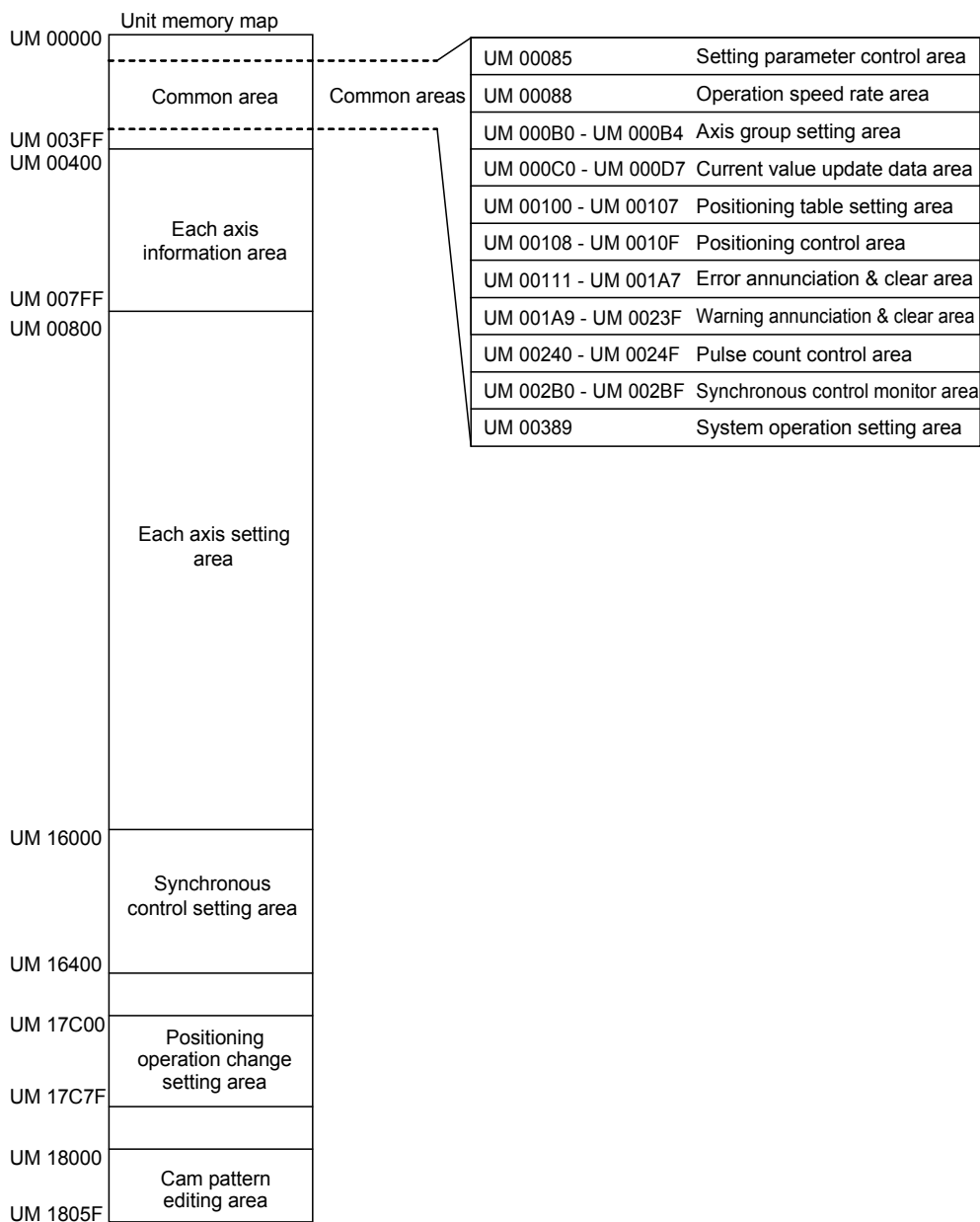

Specifications

17.4.2 Setting Parameter Control Area

Set a recalculation starting table number in order to recalculate the positioning data in the standard area.

Unit memory no. (Hex)	Name	Default	Description
UM 00085	Recalculation starting table number	U1	If the ON state of the recalculation request signal (contact Y7) is detected, the positioning unit will recalculate positioning data on all axes beginning with this table number up to number 600.

17.4.3 Operating Speed Factor Area

This is an area that all operations related to axis operations are performed at a specified rate of operation speed.

Unit memory no. (Hex)	Name	Default	Description
UM 00088	Operating speed factor	U100	All operations relating to axes (positioning, JOG, home return) can be performed at the specified rate. Setting range: 1 to 100, Unit: %

17.4.4 Axis Group Setting Area

Set an interpolation group on an axis-by-axis basis in this area.

Unit memory no. (Hex)	Name	Default	Description																					
UM 000B0	Group A axis settings	H0	<p>Make independent and interpolation settings for each axis in this area. In the case of interpolation, each axis belongs to group A, B, C, or D. For example, if the 1st, 2nd, and 3rd axes belong to group A for three-axis interpolation, set the three corresponding bits for the interpolation settings for group A to 1. In the case of single independent settings, the axis will not belong to any group. Then turn ON the corresponding bit for the following independent axis settings. Maximum number of interpolation axis per group is 3. The same axis cannot be set in more than one group.</p> <p>A maximum of three axes can be set for interpolation per group. Duplicated settings for the same axis in different groups are not possible.</p> <table border="1"> <thead> <tr> <th>bit</th> <th>Name</th> <th>Default</th> <th>Description</th> </tr> </thead> <tbody> <tr> <td>0</td> <td>Group attribute of 1st axis</td> <td>0</td> <td rowspan="4"> 0: Not belong to the interpolation group. 1: An error occurs if more than 4 bits are set to 1 in the group belonging to the interpolation group, or the same axis is set to 1 in another group.. </td> </tr> <tr> <td>1</td> <td>Group attribute of 2nd axis</td> <td>0</td> </tr> <tr> <td>2</td> <td>Group attribute of 3rd axis</td> <td>0</td> </tr> <tr> <td>3</td> <td>Group attribute of 4th axis</td> <td>0</td> </tr> <tr> <td>15 to 4</td> <td>—</td> <td>—</td> <td>—</td> </tr> </tbody> </table>	bit	Name	Default	Description	0	Group attribute of 1st axis	0	0: Not belong to the interpolation group. 1: An error occurs if more than 4 bits are set to 1 in the group belonging to the interpolation group, or the same axis is set to 1 in another group..	1	Group attribute of 2nd axis	0	2	Group attribute of 3rd axis	0	3	Group attribute of 4th axis	0	15 to 4	—	—	—
bit	Name	Default		Description																				
0	Group attribute of 1st axis	0		0: Not belong to the interpolation group. 1: An error occurs if more than 4 bits are set to 1 in the group belonging to the interpolation group, or the same axis is set to 1 in another group..																				
1	Group attribute of 2nd axis	0																						
2	Group attribute of 3rd axis	0																						
3	Group attribute of 4th axis	0																						
15 to 4	—	—	—																					
UM 000B1	Group B axis settings	H0																						
UM 000B2	Group C axis settings	H0																						
UM 000B3	Group D axis settings	H0																						

17.4 Details of Common Area in Unit Memory

Unit memory no. (Hex)	Name	Default	Description			
UM 000B4	Independent axis settings	H0	Set the corresponding bit to 1 in this area if the axis is not related to interpolation.			
			bit	Name	Default	Description
			0	Group attribute of 1st axis	0	0: Belong to the interpolation group, or not set as used axes. 1: An error occurs when setting the interpolation group of independent axis (that does not belong to the interpolation group).
			1	Group attribute of 2nd axis	0	
			2	Group attribute of 3rd axis	0	
			3	Group attribute of 4th axis	0	
15 to 4	—	—	—			

17.4.5 Current Value Update Data Area

To change the current value of each axis under the control of the positioning unit, store the changed coordinates in this area and turn ON the current value update request flag.

Unit memory no. (Hex)	Name	Default	Description			
UM 000C0	Current value update request flag	H0	Only when the corresponding bit for each axis changes to 1 from 0, the current coordinate controlled by the positioning unit to the following current value. After the change, the positioning unit will clear the corresponding bits to 0 automatically.			
			bit	Name	Default	Description
			0	Current value update request for 1st axis	0	0: No change 1: Update the current value of the corresponding axis (The positioning unit will set the value to 0 automatically after execution.)
			1	Current value update request for 2nd axis	0	
			2	Current value update request for 3rd axis	0	
			3	Current value update request for 4th axis	0	
			6 to 4	—	—	
			7	Current value update request for virtual axis	0	
15 to 8	—	—	—			
UM 000C8 -UM 000C9	Current value update coordinate of 1st axis	K0	Stores the coordinate value to be preset as the current value of each axis.			
UM 000CA -UM 000CB	Current value update coordinate of 2nd axis	K0				
UM 000CC -UM 000CD	Current value update coordinate of 3rd axis	K0				
UM 000CE -UM 000CF	Current value update coordinate of 4th axis	K0				
UM 000D6 -UM 000D7	Current value update coordinate of virtual axis	K0				

17.4.6 Positioning Control Starting Table Number Setting Area

Set the starting table number of positioning data on each axis at the time of starting positioning control.

The setting ranges are 1 to 600 for the standard area and 10001 to 10100 for the extended area.

Unit memory no. (Hex)	Name	Default	Description
UM 00100	The starting table number for the positioning control of 1st axis	U1	Stores the table number of each axis starting the position control. Setting range: Standard area: 1 to 600, Expansion area: 10001 to 10100
UM 00101	The starting table number for the positioning control of 2nd axis	U1	
UM 00102	The starting table number for the positioning control of the 3rd axis	U1	
UM 00103	The starting table number for the positioning control of 4th axis	U1	
UM 00107	The starting table number for the positioning control of the virtual axis	U1	

(Note 1):Table numbers 10026 to 10100 are available for the unit Ver.1.5 or later.

17.4.7 Positioning Control Area

Set the number of repetitions of positioning control per axis. The positioning control operation will be complete after repeating the operation for a specified number of times. The repeat count is changed to the default value on completion of the operation.

Unit memory no. (Hex)	Name	Default	Description
UM 00108	Number of 1st axis positioning repetitions	U0	Stores the number of times for repeating the operation starting from the position control starting table number until the E point. Setting range: 0 to 255 When 255 is stored, the positioning control is repeated unlimitedly until the operation is stopped.
UM 00109	Number of 2nd axis positioning repetitions	U0	
UM 0010A	Number of 3rd axis positioning repetitions	U0	
UM 0010B	Number of 4th axis positioning repetitions	U0	
UM 0010F	Number of Virtual axis positioning repetitions	U0	

17.4.8 Error Annunciation & Clear Area

This is an area in which the number of occurrences of errors and error codes are stored. For details of the operation, refer to “Chapter15 Errors and Warnings”.

Unit memory no. (Hex)	Name	Description																													
UM 00111	Error clear settings on an axis-by-axis basis	Clears errors on an axis-by-axis basis.																													
		<table border="1"> <thead> <tr> <th>bit</th> <th>Name</th> <th>Default</th> <th>Description</th> </tr> </thead> <tbody> <tr> <td>0</td> <td>Error clear for 1st axis</td> <td>0</td> <td rowspan="4">0: No error clear 0 to 1: Error clear executed (The positioning unit will set the value to 0 automatically after execution.)</td> </tr> <tr> <td>1</td> <td>Error clear for 2nd axis</td> <td>0</td> </tr> <tr> <td>2</td> <td>Error clear for 3rd axis</td> <td>0</td> </tr> <tr> <td>3</td> <td>Error clear for 4th axis</td> <td>0</td> </tr> <tr> <td>6 to 4</td> <td>–</td> <td>–</td> <td></td> </tr> <tr> <td>7</td> <td>Error clear for virtual axis</td> <td>0</td> <td></td> </tr> <tr> <td>15 to 8</td> <td>–</td> <td>–</td> <td>–</td> </tr> </tbody> </table>	bit	Name	Default	Description	0	Error clear for 1st axis	0	0: No error clear 0 to 1: Error clear executed (The positioning unit will set the value to 0 automatically after execution.)	1	Error clear for 2nd axis	0	2	Error clear for 3rd axis	0	3	Error clear for 4th axis	0	6 to 4	–	–		7	Error clear for virtual axis	0		15 to 8	–	–	–
		bit	Name	Default	Description																										
		0	Error clear for 1st axis	0	0: No error clear 0 to 1: Error clear executed (The positioning unit will set the value to 0 automatically after execution.)																										
		1	Error clear for 2nd axis	0																											
		2	Error clear for 3rd axis	0																											
		3	Error clear for 4th axis	0																											
6 to 4	–	–																													
7	Error clear for virtual axis	0																													
15 to 8	–	–	–																												
UM 00129	No. of occurrences of errors on 1st axis	Annunciates the number of occurrences of errors on the 1st axis.																													
UM 0012A- UM 0012B	1st axis error code annunciation buffer 1	The latest error codes are stored in order from buffer number 1.																													
UM 0012C- UM 0012D	1st axis error code annunciation buffer 2																														
UM 0012E- UM 0012F	1st axis error code annunciation buffer 3																														
UM 00130 -UM 00131	1st axis error code annunciation buffer 4																														
UM 00132 -UM 00133	1st axis error code annunciation buffer 5																														
UM 00134 -UM 00135	1st axis error code annunciation buffer 6																														
UM 00136 -UM 00137	1st axis error code annunciation buffer 7																														
UM 00139	No. of occurrences of errors on 2nd axis	Annunciates the number of occurrences of errors on the 2nd axis.																													
UM 0013A -UM 0013B	2nd axis error code annunciation buffer 1	The latest error codes are stored in order from buffer number 1.																													
UM 0013C -UM 0013D	2nd axis error code annunciation buffer 2																														
UM 0013E -UM 0013F	2nd axis error code annunciation buffer 3																														
UM 00140 -UM 00141	2nd axis error code annunciation buffer 4																														
UM 00142 -UM 00143	2nd axis error code annunciation buffer 5																														
UM 00144 -UM 00145	2nd axis error code annunciation buffer 6																														
UM 00146 -UM 00147	2nd axis error code annunciation buffer 7																														

Specifications

Unit memory no. (Hex)	Name	Description
UM 00149	No. of occurrences of errors on 3rd axis	No. or occurrences of errors on the 3rd axis.
UM 0014A -UM 0014B	3rd axis error code annunciation buffer 1	The latest error codes are stored in order from buffer number 1.
UM 0014C -UM 0014D	3rd axis error code annunciation buffer 2	
UM 0014E -UM 0014F	3rd axis error code annunciation buffer 3	
UM 00150 -UM 00151	3rd axis error code annunciation buffer 4	
UM 00152 -UM 00153	3rd axis error code annunciation buffer 5	
UM 00154 -UM 00155	3rd axis error code annunciation buffer 6	
UM 00156 -UM 00157	3rd axis error code annunciation buffer 7	
UM 00159	No. of occurrences of errors on 4th axis	
UM 0015A -UM 0015B	4th axis error code annunciation buffer 1	The latest error codes are stored in order from buffer number 1.
UM 0015C -UM 0015D	4th axis error code annunciation buffer 2	
UM 0015E -UM 0015F	4th axis error code annunciation buffer 3	
UM 00160 vUM 00161	4th axis error code annunciation buffer 4	
UM 00162 -UM 00163	4th axis error code annunciation buffer 5	
UM 00164 -UM 00165	4th axis error code annunciation buffer 6	
UM 00166 -UM 00167	4th axis error code annunciation buffer 7	
UM 00199	No. of occurrences of errors on virtual axis	
UM 0019A UM 0019B	Virtual axis error code annunciation buffer 1	The latest error codes are stored in order from buffer number 1.
UM 0019C UM 0019D	Virtual axis error code annunciation buffer 2	
UM 0019E UM 0019F	Virtual axis error code annunciation buffer 3	
UM 001A0 UM 001A1	Virtual axis error code annunciation buffer 4	
UM 001A2 UM 001A3	Virtual axis error code annunciation buffer 5	
UM 001A4 UM 001A5	Virtual axis error code annunciation buffer 6	
UM 001A6 UM 001A7	Virtual axis error code annunciation buffer 7	

17.4.9 Warning Annunciation & Clear Area

This is an area in which the number of occurrences of warnings and warning codes are stored. For details of the operation, refer to “Chapter15 Errors and Warnings”.

Unit memory no. (Hex)	Name	Description																										
UM 001A9	Warning clear settings on axis-by-axis basis	Clears warnings on an axis-by-axis basis																										
		<table border="1"> <thead> <tr> <th>bit</th> <th>Name</th> <th>Default</th> <th>Description</th> </tr> </thead> <tbody> <tr> <td>0</td> <td>Warning clear on 1st axis</td> <td>0</td> <td rowspan="7">0: No warning clear 0 to 1: Warning clear executed (The positioning unit will set the value to 0 automatically after execution.)</td> </tr> <tr> <td>1</td> <td>Warning clear on 2nd axis</td> <td>0</td> </tr> <tr> <td>2</td> <td>Warning clear on 3rd axis</td> <td>0</td> </tr> <tr> <td>3</td> <td>Warning clear on 4th axis</td> <td>0</td> </tr> <tr> <td>6 to 4</td> <td>–</td> <td>–</td> </tr> <tr> <td>7</td> <td>Warning clear for virtual axis</td> <td>0</td> </tr> <tr> <td>15 to 8</td> <td>–</td> <td>–</td> </tr> </tbody> </table>	bit	Name	Default	Description	0	Warning clear on 1st axis	0	0: No warning clear 0 to 1: Warning clear executed (The positioning unit will set the value to 0 automatically after execution.)	1	Warning clear on 2nd axis	0	2	Warning clear on 3rd axis	0	3	Warning clear on 4th axis	0	6 to 4	–	–	7	Warning clear for virtual axis	0	15 to 8	–	–
		bit	Name	Default	Description																							
		0	Warning clear on 1st axis	0	0: No warning clear 0 to 1: Warning clear executed (The positioning unit will set the value to 0 automatically after execution.)																							
		1	Warning clear on 2nd axis	0																								
		2	Warning clear on 3rd axis	0																								
		3	Warning clear on 4th axis	0																								
		6 to 4	–	–																								
7	Warning clear for virtual axis	0																										
15 to 8	–	–																										
UM 001C1	No. of occurrences of warnings	Annunciates the number of occurrences of warnings on the 1st axis																										
UM 001C2 -UM 001C3	1st axis warning code annunciation buffer 1	The latest warning codes are stored in order from buffer number 1.																										
UM 001C4 -UM 001C5	1st axis warning code annunciation buffer 2																											
UM 001C6 -UM 001C7	1st axis warning code annunciation buffer 3																											
UM 001C8 -UM 001C9	1st axis warning code annunciation buffer 4																											
UM 001CA -UM 001CB	1st axis warning code annunciation buffer 5																											
UM 001CC -UM 001CD	1st axis warning code annunciation buffer 6																											
UM 001CE -UM 001CF	1st axis warning code annunciation buffer 7																											
UM 001D1	No. of occurrences of warnings on the 2nd axis	Annunciates the number of occurrences of warnings on the 2nd axis.																										
UM 001D2 -UM 001D3	2nd axis warning code annunciation buffer 1	The latest warning codes are stored in order from buffer number 1.																										
UM 001D4 -UM 001D5	2nd axis warning code annunciation buffer 2																											
UM 001D6 -UM 001D7	2nd axis warning code annunciation buffer 3																											
UM 001D8 UM 001D9	2nd axis warning code annunciation buffer 4																											
UM 001DA UM 001DB	2nd axis warning code annunciation buffer 5																											

Specifications

Unit memory no. (Hex)	Name	Description
UM 001DC UM 001DD	2nd axis warning code annunciation buffer 6	The latest warning codes are stored in order from buffer number 1.
UM 001DE -UM 001DF	2nd axis warning code annunciation buffer 7	
UM 001E1	No. of occurrences of warnings on the 3rd axis	Annunciates the number of occurrences of warnings on the 3rd axis.
UM 001E2 -UM 001E3	3rd axis warning code annunciation buffer 1	The latest warning codes are stored in order from buffer number 1.
UM 001E4 -UM 001E5	3rd axis warning code annunciation buffer 2	
UM 001E6 -UM 001E7	3rd axis warning code annunciation buffer 3	
UM 001E8 -UM 001E9	3rd axis warning code annunciation buffer 4	
UM 001EA -UM 001EB	3rd axis warning code annunciation buffer 5	
UM 001EC -UM 001ED	3rd axis warning code annunciation buffer 6	
UM 001EE -UM 001EF	3rd axis warning code annunciation buffer 7	
UM 001F1	No. of occurrences of warnings on the 4th axis	
UM 001F2 -UM 001F3	4th axis warning code annunciation buffer 1	The latest warning codes are stored in order from buffer number 1.
UM 001F4 -UM 001F5	4th axis warning code annunciation buffer 2	
UM 001F6 -UM 001F7	4th axis warning code annunciation buffer 3	
UM 001F8 -UM 001F9	4th axis warning code annunciation buffer 4	
UM 001FA -UM 001FB	4th axis warning code annunciation buffer 5	
UM 001FC -UM 001FD	4th axis warning code annunciation buffer 6	
UM 001FE -UM 001FF	4th axis warning code annunciation buffer 7	
UM 00231	No. of occurrences of warnings on the virtual axis	
UM 00232 -UM 00233	Virtual axis warning code annunciation buffer 1	The latest warning codes are stored in order from buffer number 1.
UM 00234 -UM 00235	Virtual axis warning code annunciation buffer 2	
UM 00236 -UM 00237	Virtual axis warning code annunciation buffer 3	
UM 00238 -UM 00239	Virtual axis warning code annunciation buffer 4	
UM 0023A -UM 0023B	Virtual axis warning code annunciation buffer 5	
UM 0023C -UM 0023D	Virtual axis warning code annunciation buffer 6	
UM 0023E -UM 0023F	Virtual axis warning code annunciation buffer 7	

17.4.10 Pulse Count Control Area

Performs the control of pulse input according to a selected pulse input application.

Unit memory no. (Hex)	Name	Default	Description			
UM 00240	Pulse count enable flag	H0	This flag is valid when "High-speed counter" is selected for the pulse input application. When the corresponding bit to each axis is 0, the count of pulse input will start.			
			bit	Name	Default	Description
			0	1st axis pulse count enabled	0	0: Pulse input count enabled 1: Pulse input count disabled
			1	2nd axis pulse count enabled	0	
			2	3rd axis pulse count enabled	0	
			3	4th axis pulse count enabled	0	
15 to 4	–	–				
UM 00241	Pulse count value change request flag	H0	This flag is valid when "Feedback pulse" or "High-speed counter" is selected for the pulse input application. This flag is an edge trigger. When the corresponding bit to each axis changes to 1 from 0, the pulse input counter value of each axis will be changed to the value stored in "pulse input change value (UM00248 to UM0024F)".			
			bit	Name	Default	Description
			0	1st axis pulse count change	0	0: Pulse input count change disabled 0→1: Pulse input count change enabled
			1	2nd axis pulse count change	0	
			2	3rd axis pulse count change	0	
			3	4th axis pulse count change	0	
15 to 4	–	–				
UM 00248 -UM 00249	Pulse input change value of 1st axis	K0	Set the desired pulse input value to replace the current value for each axis.			
UM 0024A -UM 0024B	Pulse input change value of 2nd axis	K0				
UM 0024C -UM 0024D	Pulse input change value of 3rd axis	K0				
UM 0024E -UM 0024F	Pulse input change value of 4th axis	K0				

17.4.11 Synchronous Control Monitor Area

This is an area for monitoring the setting status of synchronous control.

Unit memory no. (Hex)	Name	Description																																						
UM 002B0	Monitoring information of synchronous master axis for the 1st axis	Stores the setting status of the master axis under synchronous control.																																						
		<table border="1"> <thead> <tr> <th colspan="2">Stored value</th> <th rowspan="2">Master axis</th> </tr> <tr> <th>Under synchronization</th> <th>Under synchronous cancellation</th> </tr> </thead> <tbody> <tr> <td>HFFFF</td> <td>H FFFF</td> <td>No synchronous settings</td> </tr> <tr> <td>H0000</td> <td>H 8000</td> <td>The master axis is subject to monitoring.</td> </tr> <tr> <td>H 0001</td> <td>H 8001</td> <td>1st axis</td> </tr> <tr> <td>H 0002</td> <td>H 8002</td> <td>2nd axis</td> </tr> <tr> <td>H 0003</td> <td>H 8003</td> <td>3rd axis</td> </tr> <tr> <td>H 0004</td> <td>H 8004</td> <td>4th axis</td> </tr> <tr> <td>H 0010</td> <td>H 8010</td> <td>Virtual axis</td> </tr> <tr> <td>H 0021</td> <td>H 8021</td> <td>Pulse input 1</td> </tr> <tr> <td>H 0022</td> <td>H 8022</td> <td>Pulse input 2</td> </tr> <tr> <td>H 0023</td> <td>H 8023</td> <td>Pulse input 3</td> </tr> <tr> <td>H 0024</td> <td>H 8024</td> <td>Pulse input 4</td> </tr> </tbody> </table>	Stored value		Master axis	Under synchronization	Under synchronous cancellation	HFFFF	H FFFF	No synchronous settings	H0000	H 8000	The master axis is subject to monitoring.	H 0001	H 8001	1st axis	H 0002	H 8002	2nd axis	H 0003	H 8003	3rd axis	H 0004	H 8004	4th axis	H 0010	H 8010	Virtual axis	H 0021	H 8021	Pulse input 1	H 0022	H 8022	Pulse input 2	H 0023	H 8023	Pulse input 3	H 0024	H 8024	Pulse input 4
		Stored value		Master axis																																				
		Under synchronization	Under synchronous cancellation																																					
		HFFFF	H FFFF	No synchronous settings																																				
		H0000	H 8000	The master axis is subject to monitoring.																																				
		H 0001	H 8001	1st axis																																				
		H 0002	H 8002	2nd axis																																				
		H 0003	H 8003	3rd axis																																				
		H 0004	H 8004	4th axis																																				
		H 0010	H 8010	Virtual axis																																				
H 0021	H 8021	Pulse input 1																																						
H 0022	H 8022	Pulse input 2																																						
H 0023	H 8023	Pulse input 3																																						
H 0024	H 8024	Pulse input 4																																						
UM 002B1	Monitoring selection state of synchronous output function for 1st axis	The state of the synchronous operating function set for the axis is stored.																																						
		<table border="1"> <thead> <tr> <th>bit</th> <th>Functions</th> <th>Setting</th> </tr> </thead> <tbody> <tr> <td>0</td> <td>Electronic gear setting</td> <td rowspan="5">0: No 1: Yes</td> </tr> <tr> <td>1</td> <td>Clutch operation settings</td> </tr> <tr> <td>2</td> <td>Electronic cam operation settings</td> </tr> <tr> <td>3</td> <td>Advance angle correction synchronous setting</td> </tr> <tr> <td>15 to 4</td> <td></td> </tr> </tbody> </table>	bit	Functions	Setting	0	Electronic gear setting	0: No 1: Yes	1	Clutch operation settings	2	Electronic cam operation settings	3	Advance angle correction synchronous setting	15 to 4																									
		bit	Functions	Setting																																				
		0	Electronic gear setting	0: No 1: Yes																																				
		1	Clutch operation settings																																					
		2	Electronic cam operation settings																																					
3	Advance angle correction synchronous setting																																							
15 to 4																																								
UM 002B2	Monitoring information of synchronous master axis for the 2nd axis	Refer to the description for the 1st axis.																																						
UM 002B3	Monitoring selection state of synchronous output function for 2nd axis																																							
UM 002B4	Monitoring information of synchronous master axis for the 3rd axis																																							
UM 002B5	Monitoring selection state of synchronous output function for 3rd axis																																							
UM 002B6	Monitoring information of synchronous master axis for the 4th axis																																							
UM 002B7	Monitoring selection state of synchronous output function for 4th axis																																							
UM 002BE	Monitoring information of synchronous master axis for the virtual axis		Refer to the description for the 1st axis.																																					
UM 002BF	Monitoring selection state of synchronous output function for virtual axis	H0000 (fixed)																																						

17.4.12 System Operation Setting Area

This is an area for changing the operation of the positioning unit.

Unit memory no. (Hex)	Name	Default	Description
UM 00389	Deceleration stop operation	U0	<p>Specify the operation of the positioning unit with the deceleration stop request signal activated (turned ON).</p> <p>0: Deceleration stop While the positioning unit is in repetitive operation, the positioning unit will come to a stop after the position moves to E-point of the repetitive target.</p> <p>1: Pause</p> <ul style="list-style-type: none"> • Performs a deceleration stop, and positioning will restart when the deceleration stop request signal is canceled (turned OFF). • The positioning unit will perform the same operation as a deceleration stop unless the positioning unit is in positioning operation. • While the positioning unit is in repetitive operation, the positioning unit will come to a stop after the position moves to the E-point of the repetitive target, and repetitive operation will restart when the deceleration stop request signal is canceled (turned OFF). • If a system stop or emergency stop is executed while the positioning unit is paused, the pause state will be canceled and the operation will not restart with the deceleration stop request signal is canceled (turned OFF).

17.5 Details of Each Axis Information Area in Unit Memory

17.5.1 Each Axis Information & Monitor Area

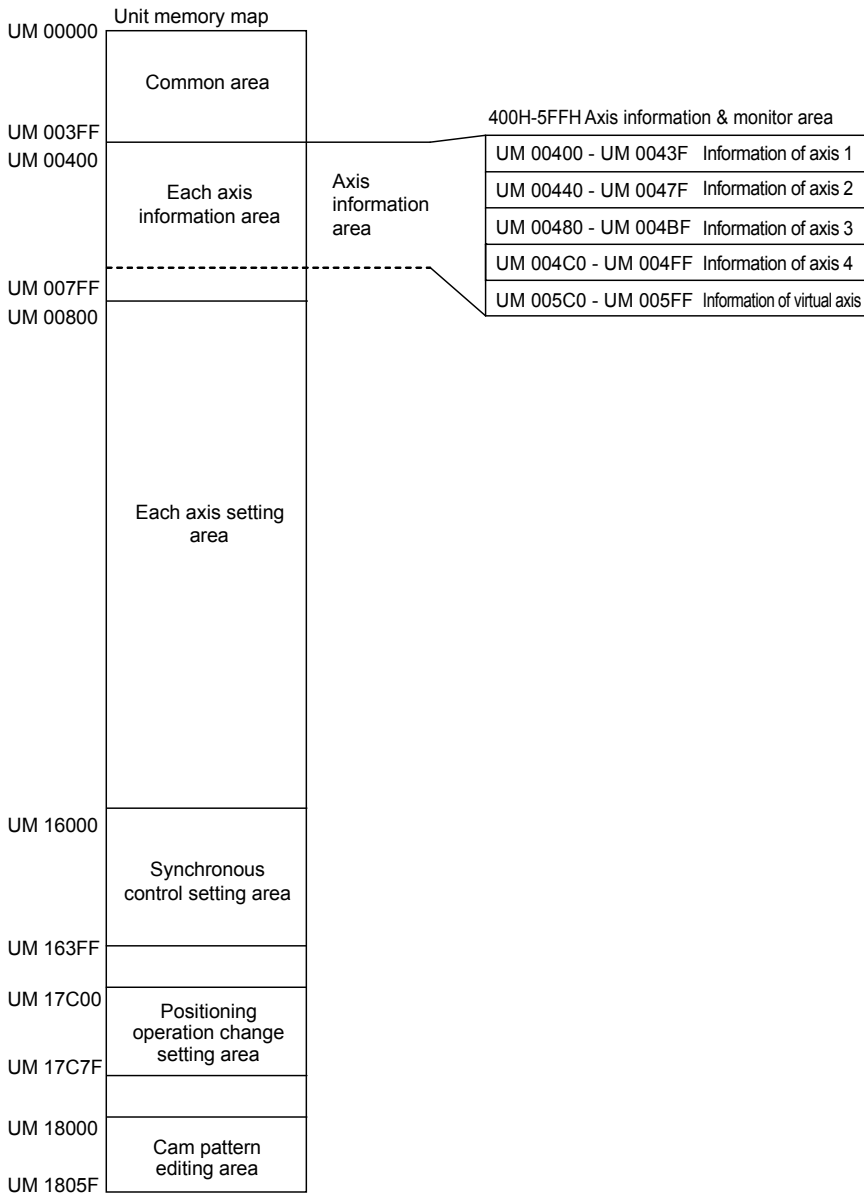

NOTE

Check that the positioning ready flag (X0) is turned ON in the case of reading each axis information area with a program.

17.5.2 Each Axis Information & Monitor Area

■ 1st axis information

Unit memory no. (Hex)	Name	Description																					
UM00424 -UM00425	Advance angle correction amount of 1st axis	Stores the advance angle correction amount. Stores values converted with the unit system (pulse, μm , inch, degree) selected for the master axis.																					
UM 00431	External terminal input monitor of 1st axis	Stores I/O information connected to each axis. <table border="1" style="width: 100%; border-collapse: collapse;"> <thead> <tr> <th>bit</th> <th>Name</th> <th>Default</th> <th>Description</th> </tr> </thead> <tbody> <tr> <td>0</td> <td>Limit +</td> <td>0</td> <td rowspan="5">0: Non-active 1: Active</td> </tr> <tr> <td>1</td> <td>Limit -</td> <td>0</td> </tr> <tr> <td>2</td> <td>Near home</td> <td>0</td> </tr> <tr> <td>3</td> <td>Home position</td> <td>0</td> </tr> <tr> <td>15 to 4</td> <td>-</td> <td>-</td> <td>-</td> </tr> </tbody> </table>	bit	Name	Default	Description	0	Limit +	0	0: Non-active 1: Active	1	Limit -	0	2	Near home	0	3	Home position	0	15 to 4	-	-	-
bit	Name	Default	Description																				
0	Limit +	0	0: Non-active 1: Active																				
1	Limit -	0																					
2	Near home	0																					
3	Home position	0																					
15 to 4	-	-		-																			
UM 00434 -UM 00435	Deviation of 1st axis	Stores the maximum value of the deviation (the difference between the pulse input value and instruction value).																					
UM 00436 -UM 00437	Pulse input value of 1st axis	Stores pulse input values according to the pulse input application (pulser, feedback pulse, or counter). Pulse input values will be integrated and stored until the pulse input application is changed or the pulse input is cleared. Unit: Pulse																					
UM 00438	Implementation or implementation done table of 1st axis	Stores the positioning table number being executed or done. Range: 1 to 600, 10001 to 10100																					
UM 00439	Auxiliary output code of 1st axis	Stores the auxiliary output code.																					
UM 0043A	Repeat count set value of 1st axis	Stores the set value for the number of positioning repeat count. This area will be set to 1 if the positioning repeat is not implemented. Stores 255 if the number of positioning repeat times is unlimited. Range: 0 to 255																					
UM 0043B	Repeat count current value 1st axis	Stores the number of repeat count in operation. Stores 1 if the positioning repeat is not implemented. Returns to "0" when the repeat count exceeds the upper limit. Range: 0 to 255																					
UM 0043C -UM 0043D	Current value of 1st axis	Stores the current value based on a mechanical origin in pulse units. It will be reset to "0" on the completion of home return. The value will not be updated when the current value update function is executed. Unit: Pulse																					
UM 0043E -UM 0043F	Unit system conversion current value of 1st axis	Stores the current value based on an electric origin (value set as home position coordinate). Values converted with the unit system (pulse, μm , inch, degree) selected in each axis setting area are stored. When the home return is completed, the value set as home position coordinate will be stored. When "0" is set as home position coordinate, it will be reset to "0". This area is also updated when the current value update function is used.																					

Specifications

■ 2nd axis information

Unit memory no. (Hex)	Name	Description
UM 00464 -UM 00465	Advance angle correction amount of 2nd axis	Refer to the description for the 1st axis.
UM 00471	External terminal input monitor of 2nd axis	Refer to the description for the 1st axis.
UM 00474	Deviation of 2nd axis	Refer to the description for the 1st axis.
UM 00476 -UM 00477	Pulse input value of 2nd axis	Refer to the description for the 1st axis.
UM 00478	Implementation or implementation done table of 2nd axis	Refer to the description for the 1st axis.
UM 00479	Auxiliary output code of 2nd axis	Refer to the description for the 1st axis.
UM 0047A	Repeat count set value of 2nd axis	Refer to the description for the 1st axis.
UM 0047B	Repeat count current value of 2nd axis	Refer to the description for the 1st axis.
UM 0047C -UM 0047D	Current value of 2nd axis	Refer to the description for the 1st axis.
UM 0047E -UM 0047F	Unit system conversion current value of 2nd axis	Refer to the description for the 1st axis.

■ 3rd axis information

Unit memory no. (Hex)	Name	Description
UM 004A4 -UM 004A5	Advance angle correction amount of 3rd axis	Refer to the description for the 1st axis.
UM 004B1	External terminal input monitor of 3rd axis	Refer to the description for the 1st axis.
UM 004B4	Deviation of 3rd axis	Refer to the description for the 1st axis.
UM 004B6 -UM 004B7	Pulse input value of 3rd axis	Refer to the description for the 1st axis.
UM 004B8	Implementation or implementation done table of 3rd axis	Refer to the description for the 1st axis.
UM 004B9	Auxiliary output code of 3rd axis	Refer to the description for the 1st axis.
UM 004BA	Repeat count set value of 3rd axis	Refer to the description for the 1st axis.
UM 004BB	Repeat count current value of 3rd axis	Refer to the description for the 1st axis.
UM 004BC -UM 004BD	Current value of 3rd axis	Refer to the description for the 1st axis.
UM 004BE -UM 004BF	Unit system conversion current value of 3rd axis	Refer to the description for the 1st axis.

17.5 Details of Each Axis Information Area in Unit Memory

■ 4th axis information

Unit memory no. (Hex)	Name	Description
UM 004E4 -UM 004E5	Advance angle correction amount of 4th axis	Refer to the description for the 1st axis.
UM 004F4	Deviation of 4th axis	Refer to the description for the 1st axis.
UM 004F6 -UM 004F7	Pulse input value of 4th axis	Refer to the description for the 1st axis.
UM 004F8	Implementation or implementation done table of 4th axis	Refer to the description for the 1st axis.
UM 004F9	Auxiliary output code of 4th axis	Refer to the description for the 1st axis.
UM 004FA	Repeat count set value of 4th axis	Refer to the description for the 1st axis.
UM 004FB	Repeat count current value of 4th axis	Refer to the description for the 1st axis.
UM 004FC -UM 004FD	Current value of 4th axis	Refer to the description for the 1st axis.
UM 004FE -UM 004FF	Unit system conversion current value of 4th axis	Refer to the description for the 1st axis.

■ Virtual axis information

Unit memory no. (Hex)	Name	Description
UM 005F8	Implementation or implementation done table of virtual axis	Refer to the description for the 1st axis.
UM 005F9	Auxiliary output code of virtual axis	Refer to the description for the 1st axis.
UM 005FA	Repeat count set value of virtual axis	Refer to the description for the 1st axis.
UM 005FB	Repeat count current value of virtual axis	Refer to the description for the 1st axis.
UM 005FC -UM 005FD	Current value of virtual axis	Refer to the description for the 1st axis.
UM 005FE -UM 005FF	Unit system conversion current value of virtual axis	Refer to the description for the 1st axis.

17.6 Details of Each Axis Setting Area in Unit Memory

17.6.1 Configuration of Each Axis Setting Area

Each axis setting area stores the parameter setting area and positioning data. The positioning data setting area of each axis consists of a standard area with 600 tables and extended area with 100 tables.

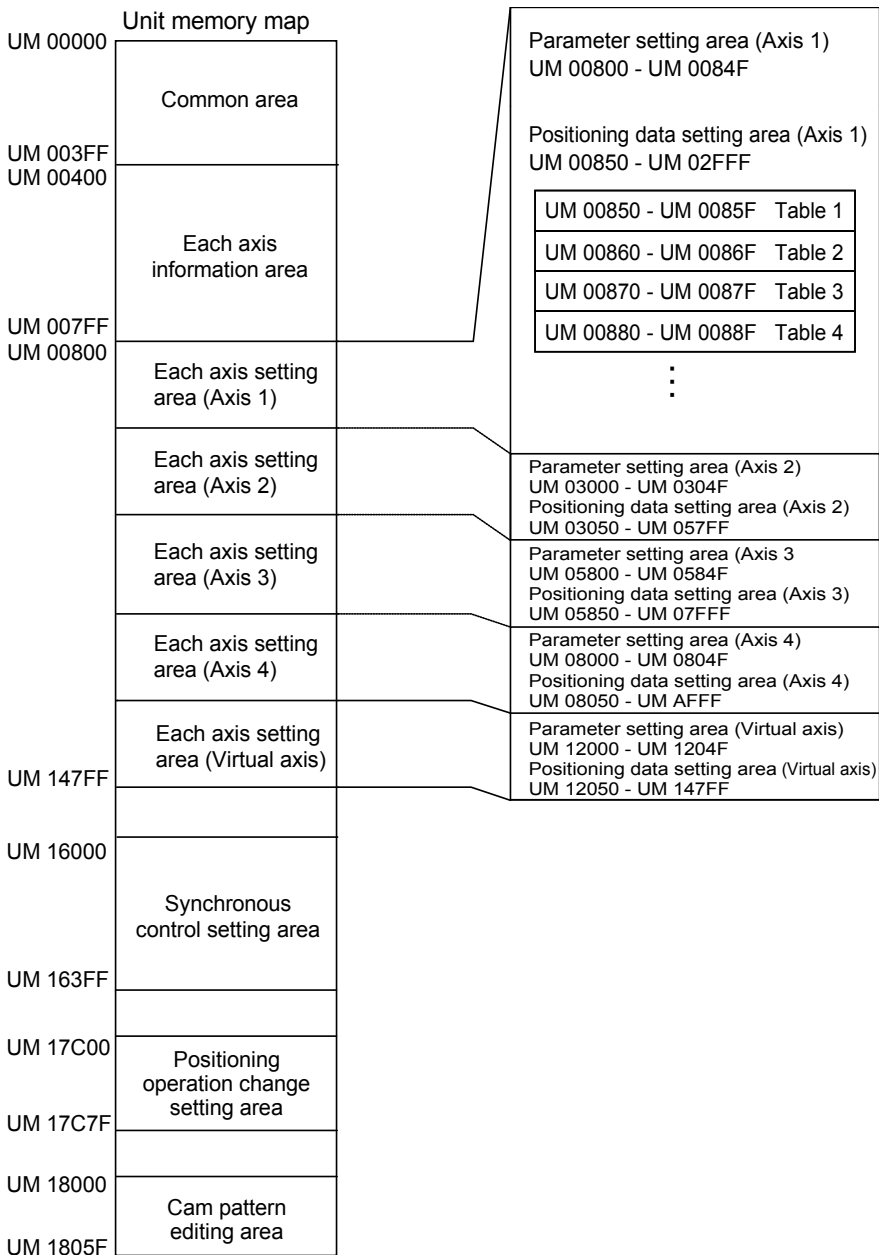

17.6.2 Positioning Parameter Setting Area

Unit memory addresses of positioning parameters are the addresses that the starting addresses allocated to each axis to which offset addresses are added.

■ First address of each axis positioning parameter area

Axis	1st axis	2nd axis	3rd axis	4th axis	Virtual axis
Unit memory address	UM 00800	UM03000	UM 05800	UM 08000	UM 12000

■ Positioning parameters

Data in the following format is stored from the first address of positioning parameters for each axis.

Offset address	Name	Default	Setting range and description
000H	Unit setting	H0	Set the movement unit system for the positioning control of each axis. Make sure that all the interpolation axes use the same unit system. H0: Pulse H100: μm (minimum position reference of 0.1 μm) H101: μm (minimum position reference of 1 μm) H200: inch (minimum position reference of 0.1 inch) H201: inch (minimum position reference of 1 inch) H300: degree (minimum position reference of 0.1 degree) H301: degree (minimum position reference of 1 degree) Any other settings will be errors.
001H	Reserved for system	–	–
002H-003H	Number of pulses per rotation	U1	Set the number of pulses per motor rotation. Settings in mm, inch, or degree are required for pulse count conversion Setting range: 1 to 32,767 Any other settings will be errors.
004H-005H	Movement amount per rotation	U1	Set the movement amount per motor rotation. Settings in mm, inch, or degree are required for pulse count conversion Setting range: 1 to 32,767 Any other settings will be errors. Set the following range according to the unit setting. μm : 1 μm inch: 1/10,000 inch degree: 1 degree
006H	Reserved for system	–	–

Specifications

Offset address	Name	Default	Setting range and description		
007H	Pulse input mode	H20	Makes pulse input signal settings. Make settings according to the application of pulse input.		
			bit	Name	Description
			0	Rotating direction	Set the rotating direction of pulse input 0: Forward 1: Reverse
			1	–	–
			3 to 2	Pulse input mode	Set the pulse input mode. bit3 bit2 0 0: 2-phase input 0 1: Direction discrimination input 1 0: Individual input 1 1: Reserve (set by default)
			5 to 4	Input multiplication	Set the desired multiplication of the pulse input count if the pulse input mode (with bits 2 and 3) to 2-phase input. bit5 bit4 0 0: x1 (multiplied by 1) 0 1: x2 (multiplied by 2) 1 0: x4 (multiplied by 4) 1 1: Reserve (set by default)
7 to 6	Pulse input application	Specify the pulse input application of each axis. • Pulser: Connects a manual pulser to pulse input. • Feedback pulse: Connects the feedback pulses of the encoder to pulse input. • High-speed counter: It is used as a general-purpose counter input. bit7 bit6 0 0: Pulser 0 1: Feedback pulse 1 0: High-speed counter 1 1: Reserve (set by default)			
15 to 8	–	–			
008H	Numerator of automatic movement amount check correction	U1	Set a correction value of pulse input at the time of making an automatic movement amount check of machinery or equipment. The following formula is used to calculate a deviation feedback value (pulse input value with a correction) from the pulse input terminal and make an automatic movement amount check.		
009H	Denominator of automatic movement amount check correction	U1	Deviation feedback value = (Correction numerator/Correction denominator) x Pulse input Setting range: 1 to 32767		

17.6 Details of Each Axis Setting Area in Unit Memory

Offset address	Name	Default	Setting range and description
00AH	Automatic movement amount checking	U0	<p>Set an action when the difference between the instruction value and feedback value exceeds the movement check value at the time of automatic movement amount check.</p> <p>0: Error An error will occur and the operation of the positioning unit will come to a stop if the difference between the feedback value and reference movement exceeds the movement check value (threshold).</p> <p>1: Warning An error will occur and the operation of the positioning unit will come to a stop if the difference between the feedback value and reference movement exceeds the movement check value (threshold).</p> <p>2: No No movement amount check is made.</p>

Specifications

Offset address	Name	Default	Setting range and description																				
00BH	Software limit enabled/disabled settings	H0	Enables or disables the software limit on each control.																				
			<table border="1"> <thead> <tr> <th>bit</th> <th>Name</th> <th>Default</th> <th>Description</th> </tr> </thead> <tbody> <tr> <td>0</td> <td>Enables/disables the software limit for positioning control</td> <td>0</td> <td>0: Disables the software limit for positioning control 1: Enables the software limit for positioning control</td> </tr> <tr> <td>1</td> <td>Enables/disables the software limit while the positioning unit is in home return operation</td> <td>0</td> <td>0: Disables the software limit for home return control 1: Enables the software limit for home return control</td> </tr> <tr> <td>2</td> <td>Enable/disable the software limit in the JOG operation</td> <td>0</td> <td>0: Disables the software limit for JOG operation 1: Enables the software limit for JOG operation</td> </tr> <tr> <td>15 to 3</td> <td>–</td> <td>–</td> <td>–</td> </tr> </tbody> </table>	bit	Name	Default	Description	0	Enables/disables the software limit for positioning control	0	0: Disables the software limit for positioning control 1: Enables the software limit for positioning control	1	Enables/disables the software limit while the positioning unit is in home return operation	0	0: Disables the software limit for home return control 1: Enables the software limit for home return control	2	Enable/disable the software limit in the JOG operation	0	0: Disables the software limit for JOG operation 1: Enables the software limit for JOG operation	15 to 3	–	–	–
			bit	Name	Default	Description																	
			0	Enables/disables the software limit for positioning control	0	0: Disables the software limit for positioning control 1: Enables the software limit for positioning control																	
			1	Enables/disables the software limit while the positioning unit is in home return operation	0	0: Disables the software limit for home return control 1: Enables the software limit for home return control																	
2	Enable/disable the software limit in the JOG operation	0	0: Disables the software limit for JOG operation 1: Enables the software limit for JOG operation																				
15 to 3	–	–	–																				
00CH -00DH	Upper limit of software limit	K1073741823	<p>Set the upper limit of the software limit for the absolute coordinates. Set the following range according to the unit setting.</p> <p>Pulse: -1,073,741,823 to +1,073,741,823 pulses</p> <p>μm (0.1 μm): -107,374,182.3 to +107,374,182.3 μm</p> <p>μm (1 μm): -1,073,741,823 to +1,073,741,823 μm</p> <p>inch (0.00001 inch): -10,737.41823 to +10,737.41823 inches</p> <p>inch (0.0001 inch): -107,374.1823 to +107,374.1823 inches</p> <p>degree (0.1 degree): -107,374,182.3 to +107,374,182.3 degrees</p> <p>degree (1 degree): -1,073,741,823 to +1,073,741,823 degrees</p> <p>Any other settings will be errors.</p>																				
00EH -00FH	Lower limit of software limit	K-1073741823	<p>Set the upper limit of the software limit for the absolute coordinates. Set the following range according to the unit setting.</p> <p>Pulse: -1,073,741,823 to +1,073,741,823 pulses</p> <p>μm (0.1 μm): -107,374,182.3 to +107,374,182.3 μm</p> <p>μm (1 μm): -1,073,741,823 to +1,073,741,823 μm</p> <p>inch (0.00001 inch): -10,737.41823 to +10,737.41823 inches</p> <p>inch (0.0001 inch): -107,374.1823 to +107,374.1823 inches</p> <p>degree (0.1 degree): 0.0 to 359.9 degrees</p> <p>degree (1 degree): 0 to 359 degrees</p> <p>Any other settings will be errors.</p>																				
010H -011H	Reserved for system	–	–																				

17.6 Details of Each Axis Setting Area in Unit Memory

Offset address	Name	Default	Setting range and description																																
012H	Auxiliary output mode	HA00	<p>Set whether to use or not to use the auxiliary output contact and auxiliary output function of the auxiliary output code whether to be used or unused.</p> <p>The ON time of the auxiliary output contact is determined by the following auxiliary output ON time.</p> <table border="1" style="width: 100%; border-collapse: collapse;"> <thead> <tr> <th style="text-align: center;">bit</th> <th style="text-align: center;">Name</th> <th style="text-align: center;">Default</th> <th style="text-align: center;">Description</th> </tr> </thead> <tbody> <tr> <td style="text-align: center;">7 to 0</td> <td style="text-align: center;">Auxiliary output mode</td> <td style="text-align: center;">H00</td> <td>0000H: The auxiliary output function (auxiliary output contact or code) is not used. 0001H: With mode used 0002H: Delay mode used</td> </tr> <tr> <td style="text-align: center;">15 to 8</td> <td style="text-align: center;">Auxiliary output ON time</td> <td style="text-align: center;">HA (10ms)</td> <td>Setting range: 00H (0 ms) to FFH (255 ms).</td> </tr> </tbody> </table>	bit	Name	Default	Description	7 to 0	Auxiliary output mode	H00	0000H: The auxiliary output function (auxiliary output contact or code) is not used. 0001H: With mode used 0002H: Delay mode used	15 to 8	Auxiliary output ON time	HA (10ms)	Setting range: 00H (0 ms) to FFH (255 ms).																				
bit	Name	Default	Description																																
7 to 0	Auxiliary output mode	H00	0000H: The auxiliary output function (auxiliary output contact or code) is not used. 0001H: With mode used 0002H: Delay mode used																																
15 to 8	Auxiliary output ON time	HA (10ms)	Setting range: 00H (0 ms) to FFH (255 ms).																																
013H	Auxiliary output Delay rate	U0	<p>When using the delay mode for the auxiliary output, specify the ratio (%) to output.</p> <p>The setting range is 0(%) to 100(%). If the setting is 50%, the auxiliary output will be performed when the positioning movement amount exceeds 50%.</p>																																
014H	Limit switch	H0	<p>Set to enable or disable the limit input.</p> <table border="1" style="width: 100%; border-collapse: collapse;"> <thead> <tr> <th style="text-align: center;">bit</th> <th style="text-align: center;">Name</th> <th style="text-align: center;">Default</th> <th style="text-align: center;">Description</th> </tr> </thead> <tbody> <tr> <td style="text-align: center;">0</td> <td style="text-align: center;">Limit enabled/disabled</td> <td style="text-align: center;">1</td> <td>0: Enables the input of limit signal. 1: Disables the input of limit signal.</td> </tr> <tr> <td style="text-align: center;">15 to 1</td> <td style="text-align: center;">-</td> <td style="text-align: center;">-</td> <td style="text-align: center;">-</td> </tr> </tbody> </table>	bit	Name	Default	Description	0	Limit enabled/disabled	1	0: Enables the input of limit signal. 1: Disables the input of limit signal.	15 to 1	-	-	-																				
bit	Name	Default	Description																																
0	Limit enabled/disabled	1	0: Enables the input of limit signal. 1: Disables the input of limit signal.																																
15 to 1	-	-	-																																
015H	Pulse output control code	H30	<p>Make pulse output, home position, near home, and limit signal settings.</p> <table border="1" style="width: 100%; border-collapse: collapse;"> <thead> <tr> <th style="text-align: center;">bit</th> <th style="text-align: center;">Name</th> <th style="text-align: center;">Default</th> <th style="text-align: center;">Description</th> </tr> </thead> <tbody> <tr> <td style="text-align: center;">0</td> <td style="text-align: center;">Output mode</td> <td style="text-align: center;">0</td> <td>0: Pulse/Sign 1: CW/CCW</td> </tr> <tr> <td style="text-align: center;">1</td> <td style="text-align: center;">Rotating direction</td> <td style="text-align: center;">0</td> <td>0: Count + Direction CW 1: Count + Direction CCW</td> </tr> <tr> <td style="text-align: center;">2</td> <td style="text-align: center;">Home logic</td> <td style="text-align: center;">0</td> <td>0: Normal Open 1: Normal Close</td> </tr> <tr> <td style="text-align: center;">3</td> <td style="text-align: center;">Near home logic</td> <td style="text-align: center;">0</td> <td>0: Normal Open 1: Normal Close</td> </tr> <tr> <td style="text-align: center;">4</td> <td style="text-align: center;">Limit + Logic</td> <td style="text-align: center;">1</td> <td>0: Normal Open 1: Normal Close</td> </tr> <tr> <td style="text-align: center;">5</td> <td style="text-align: center;">Limit - Logic</td> <td style="text-align: center;">1</td> <td>0: Normal Open 1: Normal Close</td> </tr> <tr> <td style="text-align: center;">15 to 6</td> <td style="text-align: center;">-</td> <td style="text-align: center;">0</td> <td style="text-align: center;">-</td> </tr> </tbody> </table>	bit	Name	Default	Description	0	Output mode	0	0: Pulse/Sign 1: CW/CCW	1	Rotating direction	0	0: Count + Direction CW 1: Count + Direction CCW	2	Home logic	0	0: Normal Open 1: Normal Close	3	Near home logic	0	0: Normal Open 1: Normal Close	4	Limit + Logic	1	0: Normal Open 1: Normal Close	5	Limit - Logic	1	0: Normal Open 1: Normal Close	15 to 6	-	0	-
bit	Name	Default	Description																																
0	Output mode	0	0: Pulse/Sign 1: CW/CCW																																
1	Rotating direction	0	0: Count + Direction CW 1: Count + Direction CCW																																
2	Home logic	0	0: Normal Open 1: Normal Close																																
3	Near home logic	0	0: Normal Open 1: Normal Close																																
4	Limit + Logic	1	0: Normal Open 1: Normal Close																																
5	Limit - Logic	1	0: Normal Open 1: Normal Close																																
15 to 6	-	0	-																																
016H -017H	Startup speed	U0	<p>Make startup speed settings for each type of operation.</p> <p>Make a startup speed change before starting each type of operation.</p> <p>Setting range: 0 to 32,767,000</p> <p>Any other settings will be errors.</p> <p>Set the following range according to the unit setting.</p> <p>Pulse: 1 to 32,767,000 pps</p> <p>µm: 1 to 32,767,000 µm/s</p> <p>inch: 0.001 to 32,767.000 inch/s</p> <p>degree: 0.001 to 32,767.000 rev/s</p>																																

Specifications

Offset address	Name	Default	Setting range and description
018H	Automatic movement amount check value	U10000	Set the threshold to use the automatic check function of movement amount. Setting range: 0 to 65536 Default: 10000 (pulses)
019H	Reserved for system	–	–
01AH	Automatic movement amount check interval	U0	Set the interval of automatic movement amount checking in ms . Setting range: 0 to 32767 (ms) Default: 0 (ms)
01BH-01FH	Reserved for system	–	–
020H	Home return setting code	H0	Sets the pattern of the home return. 0: DOG method 1 1: DOG method 2 2: DOG method 3 3: Limit method 1 4: Limit method 2 5: Phase Z method 8: Data set Any other settings will be errors.
021H	Home return direction	H0	Set the direction of the home return. 0: Elapsed value decrement direction (limit negative direction) 1: Elapsed value increment direction (limit positive direction) Any other settings will be errors.
022H	Acceleration time in home return operation	U100	Sets the acceleration/deceleration time while the positioning unit is in home return operation. When home return control starts, the positioning unit will go into acceleration operation in the preset time. After near home input is ON, the positioning unit will go into deceleration operation in the preset time and move into creeping speed. Setting range: 0 to 10,000 (ms) Any other settings will be errors.
023H	Deceleration time in home return operation		
024H-025H	Home return target speed error	U1000	Sets the target speed for home return control. After home return control starts, the positioning unit will accelerate to target speed if there is no near home input. Setting range: 1 to 32,767,000 Any other settings will be errors. Set the following range according to the unit setting. Pulse: 1 to 32,767,000 pps µm: 1 to 32,767,000 µm/s inch: 0.001 to 32,767.000 inch/s degree: 0.001 to 32,767.000 rev/s

17.6 Details of Each Axis Setting Area in Unit Memory

Offset address	Name	Default	Setting range and description																
026H -027H	Home return creep speed	U100	<p>Set the speed to search the home position after near home input. Set a speed lower than the target home return speed. Setting range: 1 to 32,767,000 Any other settings will be errors. Set the following range according to the unit setting. Pulse: 1 to 32,767,000 pps μm: 1 to 32,767,000 μm/s inch: 0.001 to 32,767.000 inch/s degree: 0.001 to 32,767.000 rev/s</p>																
028H	Deviation counter clear signal ON time	U1	<p>Set the ON time of the deviation counter clear signal after home return completion. Setting range: 1 to 100 ms The deviation counter clear signal is set to 100 ms even if a setting in excess of 100 ms is made.</p>																
029H	JOG operation setting code	H0	<p>Sets the operation mode of the JOG operation.</p> <table border="1" style="width: 100%; border-collapse: collapse;"> <thead> <tr> <th style="text-align: center;">bit</th> <th style="text-align: center;">Name</th> <th style="text-align: center;">Default</th> <th style="text-align: center;">Description</th> </tr> </thead> <tbody> <tr> <td style="text-align: center;">0</td> <td style="text-align: center;">-</td> <td style="text-align: center;">-</td> <td style="text-align: center;">-</td> </tr> <tr> <td style="text-align: center;">1</td> <td style="text-align: center;">Acceleration / Deceleration pattern settings</td> <td style="text-align: center;">0</td> <td style="text-align: center;">0: Linear acceleration/deceleration 1: S-shaped acceleration/deceleration</td> </tr> <tr> <td style="text-align: center;">15 to 2</td> <td style="text-align: center;">-</td> <td style="text-align: center;">-</td> <td style="text-align: center;">-</td> </tr> </tbody> </table>	bit	Name	Default	Description	0	-	-	-	1	Acceleration / Deceleration pattern settings	0	0: Linear acceleration/deceleration 1: S-shaped acceleration/deceleration	15 to 2	-	-	-
bit	Name	Default	Description																
0	-	-	-																
1	Acceleration / Deceleration pattern settings	0	0: Linear acceleration/deceleration 1: S-shaped acceleration/deceleration																
15 to 2	-	-	-																
02AH	JOG operation acceleration time	U100	<p>Sets the acceleration/deceleration time for JOG operation. When JOG operation starts, the positioning unit will go into acceleration operation in the preset time. After the start contact of JOG operation is ON, the positioning unit will go into deceleration operation in the preset time to come to a stop. Setting range: 0 to 10,000 (ms) Any other settings will be errors.</p>																
02BH	JOG operation deceleration time																		
02CH -02DH	JOG operation target speed	U1000	<p>Set the target speed for JOG operation. After the start of the JOG operation of the positioning unit, the positioning unit will accelerate to move to the target speed while the start contact of the JOG operation is ON. The positioning unit will operate at target speed after the target speed is reached. Setting range: 1 to 32,767,000 Any other settings will be errors. Set the following range according to the unit setting. Pulse: 1 to 32,767,000 pps μm: 1 to 32,767,000 μm/s inch: 0.001 to 32,767.000 inch/s degree: 0.001 to 32,767.000 rev/s</p>																
02EH -02FH	Reserved for system	-	-																

Specifications

Offset address	Name	Default	Setting range and description
030H -032H	Reserved for system	–	–
033H	Emergency stop deceleration time	U100	This parameter will be enabled if an emergency stop request is made with I/O, and the deceleration of the positioning unit will be completed in the specified deceleration time. Setting range: 0 to 10,000 (ms) Any other settings will be errors.
034H	Reserved for system	–	–
035H	Limit stop deceleration time	U100	This parameter will be enabled if limit input is ON while the positioning unit is in operation, and the deceleration of the positioning unit will be completed in the specified deceleration time. Setting range: 0 to 10,000 (ms) Any other settings will be errors.
036H	Reserved for system	–	–
037H	Error stop deceleration time	U100	This parameter will be enabled if an error occurs, and the deceleration of the positioning unit will be completed in the specified deceleration time. Setting range: 0 to 10,000 (ms) Any other settings will be errors.
038H	Pulser operation setting code	H0	If a pulse operation request is made with I/O, select the desired pulser input from pulser inputs 1 to 4. 0: Pulser input 1 1: Pulser input 2 2: Pulser input 3 3: Pulser input 4 Any other settings will be errors.
039H	Pulser operation ratio numerator	U1	Set a multiplier for the input pulse train for the operation of the pulser. The number of reference pulses is obtained from the pulse train input from the pulser multiplied by the numerator of the pulser operation ratio/denominator of pulser operation ratio. Setting range: 1 to 32,767 Any other settings will be errors.
03AH	Pulser operation ratio denominator	U1	Set a divisor for the input pulse train for the operation of the pulser. The number of reference pulses is obtained from the pulse train input from the pulser multiplied by the numerator of the pulser operation ratio/denominator of pulser operation ratio. Setting range: 1 to 32,767 Any other settings will be errors.
03BH	Pulser operation method	H0	This is the area for setting the pulser operation method. 0: Standard operation 1: Speed limit (pulse hold) 2: Speed limit (truncated) Any other settings will be errors.
03CH -03FH	Reserved for system	–	–

17.6 Details of Each Axis Setting Area in Unit Memory

Offset address	Name	Default	Setting range and description																
040H	Reserved for system	–	–																
041H	J-point control code	H0	Set the control code for J-point control.																
			<table border="1" style="width: 100%; border-collapse: collapse;"> <thead> <tr> <th style="text-align: center;">bit</th> <th style="text-align: center;">Name</th> <th style="text-align: center;">Default</th> <th style="text-align: center;">Description</th> </tr> </thead> <tbody> <tr> <td style="text-align: center;">0</td> <td style="text-align: center;">–</td> <td style="text-align: center;">–</td> <td style="text-align: center;">–</td> </tr> <tr> <td style="text-align: center;">1</td> <td style="text-align: center;">Acceleration/ Deceleration pattern settings</td> <td style="text-align: center;">0</td> <td style="text-align: center;">0: Linear acceleration/deceleration 1: S-shaped acceleration/deceleration</td> </tr> <tr> <td style="text-align: center;">15 to 2</td> <td style="text-align: center;">–</td> <td style="text-align: center;">–</td> <td style="text-align: center;">–</td> </tr> </tbody> </table>	bit	Name	Default	Description	0	–	–	–	1	Acceleration/ Deceleration pattern settings	0	0: Linear acceleration/deceleration 1: S-shaped acceleration/deceleration	15 to 2	–	–	–
			bit	Name	Default	Description													
			0	–	–	–													
1	Acceleration/ Deceleration pattern settings	0	0: Linear acceleration/deceleration 1: S-shaped acceleration/deceleration																
15 to 2	–	–	–																
042H	J-point acceleration time	U100	Sets the acceleration/deceleration time for J-point control. Setting range: 0 to 10,000 (ms) Any other settings will be errors.																
043H	J-point deceleration time																		
044H -045H	J-point target speed	U1000	Sets the target speed for J-point control. Setting range: 1 to 32,767,000 Any other settings will be errors. Set the following range according to the unit setting. Pulse: 1 to 32,767,000 pps µm: 1 to 32,767,000 µm/s inch: 0.001 to 32,767.000 inch/s degree: 0.001 to 32,767.000 rev/s																
046H -047H	Reserved for system	–	–																
048H -049H	Pulser operation max. speed	U0	The maximum speed of the pulser operation with speed limits selected. The positioning unit will operate at maximum speed if the speed obtained from pulse input multiplied by the numerator of pulse operation/denominator of pulser operation is in excess of the specified maximum speed. Unit: Set unit x 1000/s Input range: 0 to 32767000 (pulse/s) * If this area has been set to 0, it is the minimum speed in the set unit.																
04AH -04BH	Coordinate origin	–	Stores the value of coordinate origin after the home return.																
04CH	Reserved for system	–	–																

Specifications

Offset address	Name	Default	Setting range and description									
04DH	Input time constant - Pulse input (Note)	H0	<p>Set the time constant of each pulse input signal. The pulse inputs A and B of the same axis are the same input time constant.</p> <table border="1"> <thead> <tr> <th>bit</th> <th>Default</th> <th>Description</th> </tr> </thead> <tbody> <tr> <td>2 to 0</td> <td>0H</td> <td>0H: 0.1 us 1H: 0.2 us 2H: 0.5 us 3H: 1.0 us 4H: 2.0 us 5H: 10.0us 6H: No input time constant 7H: No input time constant</td> </tr> <tr> <td>15 to 3</td> <td>—</td> <td>—</td> </tr> </tbody> </table>	bit	Default	Description	2 to 0	0H	0H: 0.1 us 1H: 0.2 us 2H: 0.5 us 3H: 1.0 us 4H: 2.0 us 5H: 10.0us 6H: No input time constant 7H: No input time constant	15 to 3	—	—
bit	Default	Description										
2 to 0	0H	0H: 0.1 us 1H: 0.2 us 2H: 0.5 us 3H: 1.0 us 4H: 2.0 us 5H: 10.0us 6H: No input time constant 7H: No input time constant										
15 to 3	—	—										
04EH	Input time constant - Home input (Note)	H0	<p>Set the time constant of home input signal.</p> <table border="1"> <thead> <tr> <th>bit</th> <th>Default</th> <th>Description</th> </tr> </thead> <tbody> <tr> <td>1 to 0</td> <td>0H</td> <td>0H: No input time constant 1H: 10.0 us 2H: 100.0 us 3H: No input time constant</td> </tr> <tr> <td>15 to 2</td> <td>—</td> <td>—</td> </tr> </tbody> </table>	bit	Default	Description	1 to 0	0H	0H: No input time constant 1H: 10.0 us 2H: 100.0 us 3H: No input time constant	15 to 2	—	—
bit	Default	Description										
1 to 0	0H	0H: No input time constant 1H: 10.0 us 2H: 100.0 us 3H: No input time constant										
15 to 2	—	—										
04FH	Reserved for system	—	—									

(Note): The input time constant is available for the unit of Ver. 1.3 or later.

17.6.3 Positioning Data Setting Areas

■ Positioning table

Data in the following format is stored from the first address of the positioning table for each axis. Refer to the list in and after page 17-52 for the first address of each positioning table.

Offset address	Name	Default	Setting range and description			
000H	Control code	H0	Area to set the position specification method and acceleration/deceleration pattern of positioning.			
			bit	Name	Default	Description
			0	Control method	0	0: Increment mode 1: Absolute mode
			1	Acceleration/deceleration pattern	0	0: Linear acceleration/deceleration 1: S-shaped acceleration/deceleration
15 to 2	—	—	—	—		
001H	Operation pattern	H0	Area to set the single and interpolation operation pattern of positioning. The relationship of interpolation is in conformity with the settings for the axis group setting area in the unit memory common area. The settings for the axis with the smallest number in the axis group are enabled for interpolation control.			
			bit	Name	Default	Description
			7 to 0	Control pattern	00H	H00: E point control (End point control) H01: P point control (Pass point control) H02: C point control (Continuation point) H03: J point control (Speed point control) Any other settings will be errors.
			15 to 8	Interpolation setting	00H	H00: Linear interpolation (Composite speed) H01: Linear interpolation (Long axis speed) H10: Circular interpolation (Center point/CW direction) H11: Circular interpolation (Center point/CCW direction) H20: Circular interpolation (Pass point) H50: Spiral interpolation (Center point/CW direction/X-axis movement) H51: Spiral interpolation (Center point/CCW direction/X-axis movement) H52: Spiral interpolation (Center point/CW direction/Y-axis movement) H53: Spiral interpolation (Center point/CCW direction/Y-axis movement) H54: Spiral interpolation (Center point/CW direction/Z-axis movement) H55: Spiral interpolation (Center point/CCW direction/Z-axis movement) H60: Spiral interpolation (Pass point/X-axis movement) H61: Spiral interpolation (Pass point/Y-axis movement) H62: Spiral interpolation (Pass point/Z-axis movement) Any other settings will be errors.

Specifications

Offset address	Name	Default	Setting range and description
002H -003H	Reserved for system	–	–
004H	Positioning acceleration time	U100	<p>The setting area for acceleration time and deceleration time for positioning operation.</p> <p>Different settings can be made for acceleration and deceleration.</p> <p>The settings for the axis with the smallest number in the axis group are enabled for interpolation operation.</p> <p>Setting range: 0 to 10,000 (ms)</p> <p>Any other settings will be errors.</p>
005H	Positioning deceleration time		
006H -007H	Positioning target speed (Interpolation speed)	U1000	<p>The target axis will operate at target speed in the case of single axis operation and operate at target interpolation speed in the case of interpolation operation.</p> <p>The settings for the axis with the smallest number in the axis group are enabled for interpolation operation.</p> <p>Setting range: 1 to 32,767,000</p> <p>Any other settings will be errors.</p> <p>Set the following range according to the unit setting.</p> <p>Pulse: 1 to 32,767,000 pps</p> <p>µm: 1 to 32,767,000 µm/s</p> <p>inch: 0.001 to 32,767.000 inch/s</p> <p>degree: 0.001 to 32,767.000 rev/s</p>
008H -009H	Positioning movement amount	K0	<p>The setting area for the positioning movement amount for positioning operation.</p> <p>The amount of increment movement or absolute coordinates will be set according to the control code settings.</p> <p>Setting range: -1,073,741,823 to +1,073,741,823</p> <p>Any other settings will be errors.</p> <p>Set the following range according to the unit setting.</p> <p>Pulse: -1,073,741,823 to +1,073,741,823 pulses</p> <p>µm (0.1 µm): -107,374,182.3 to +107,374,182.3 µm</p> <p>µm (1 µm): -1,073,741,823 to +1,073,741,823 µm</p> <p>inch (0.00001 inch): -10,737.41823 to +10,737.41823 inches</p> <p>inch (0.0001 inch): -107,374.1823 to +107,374.1823 inch</p> <p>degree (0.1 degree): -107,374,182.3 to +107,374,182.3 degrees</p> <p>degree (1 degree): -1,073,741,823 to +1,073,741,823 degrees</p>

17.6 Details of Each Axis Setting Area in Unit Memory

Offset address	Name	Default	Setting range and description
00AH -00BH	Auxiliary point	K0	<p>The setting area for auxiliary points (center and passing points) in the case of circular interpolation or spiral interpolation operation.</p> <p>Setting range: -1,073,741,823 to +1,073,741,823</p> <p>Any other settings will be errors.</p> <p>Set the following range according to the unit setting.</p> <p>Pulse: -1,073,741,823 to +1,073,741,823 pulses</p> <p>μm (0.1 μm): -107,374,182.3 to +107,374,182.3 μm</p> <p>μm (1 μm): -1,073,741,823 to +1,073,741,823 μm</p> <p>inch (0.00001 inch): -10,737.41823 to +10,737.41823 inches</p> <p>inch (0.0001 inch): -107,374.1823 to +107,374.1823 inch</p> <p>degree (0.1 degree): -107,374,182.3 to +107,374,182.3 degrees</p> <p>degree (1 degree): -1,073,741,823 to +1,073,741,823 degrees</p>
00CH	Dwell Time	U0	<p>On completion of the positioning of this table, the operation of the next table will start after stopping the motor for the dwell time in the case of the continuance point (C-point), the dwell time will be ignored in the case of the passing point (P-point), and the positioning done contact will turn ON after a pause of the dwell time in the case of end point (E-point) control.</p> <p>Setting range: 0 to 32,767 (ms)</p> <p>Any other settings will be errors.</p>
00DH	Auxiliary output code	K0	<p>Make auxiliary output mode settings for the parameter setting area to specify data to be output to the auxiliary output codes for the each axis information & monitor area.</p> <p>No setting ranges, in particular.</p>
00EH -00FH	Reserved for system	-	-



◆ KEY POINTS

The unit memory address of each item on the positioning table is based on a separate address allocated to each axis and table added with the offset address.

Specifications

■ First address of each positioning table (Standard area: 1 to 600)

Table no.	1st axis	2nd axis	3rd axis	4th axis	Virtual axis
1	UM 00850	UM 03050	UM 05850	UM 08050	UM 12050
2	UM 00860	UM 03060	UM 05860	UM 08060	UM 12060
3	UM 00870	UM 03070	UM 05870	UM 08070	UM 12070
4	UM 00880	UM 03080	UM 05880	UM 08080	UM 12080
5	UM 00890	UM 03090	UM 05890	UM 08090	UM 12090
6	UM 008A0	UM 030A0	UM 058A0	UM 080A0	UM 120A0
7	UM 008B0	UM 030B0	UM 058B0	UM 080B0	UM 120B0
8	UM 008C0	UM 030C0	UM 058C0	UM 080C0	UM 120C0
9	UM 008D0	UM 030D0	UM 058D0	UM 080D0	UM 120D0
10	UM 008E0	UM 030E0	UM 058E0	UM 080E0	UM 120E0
11	UM 008F0	UM 030F0	UM 058F0	UM 080F0	UM 120F0
12	UM 00900	UM 03100	UM 05900	UM 08100	UM 12100
13	UM 00910	UM 03110	UM 05910	UM 08110	UM 12110
14	UM 00920	UM 03120	UM 05920	UM 08120	UM 12120
15	UM 00930	UM 03130	UM 05930	UM 08130	UM 12130
16	UM 00940	UM 03140	UM 05940	UM 08140	UM 12140
17	UM 00950	UM 03150	UM 05950	UM 08150	UM 12150
18	UM 00960	UM 03160	UM 05960	UM 08160	UM 12160
19	UM 00970	UM 03170	UM 05970	UM 08170	UM 12170
20	UM 00980	UM 03180	UM 05980	UM 08180	UM 12180
21	UM 00990	UM 03190	UM 05990	UM 08190	UM 12190
22	UM 009A0	UM 031A0	UM 059A0	UM 081A0	UM 121A0
23	UM 009B0	UM 031B0	UM 059B0	UM 081B0	UM 121B0
24	UM 009C0	UM 031C0	UM 059C0	UM 081C0	UM 121C0
25	UM 009D0	UM 031D0	UM 059D0	UM 081D0	UM 121D0
26	UM 009E0	UM 031E0	UM 059E0	UM 081E0	UM 121E0
27	UM 009F0	UM 031F0	UM 059F0	UM 081F0	UM 121F0
28	UM 00A00	UM 03200	UM 05A00	UM 08200	UM 12200
29	UM 00A10	UM 03210	UM 05A10	UM 08210	UM 12210
30	UM 00A20	UM 03220	UM 05A20	UM 08220	UM 12220
31	UM 00A30	UM 03230	UM 05A30	UM 08230	UM 12230
32	UM 00A40	UM 03240	UM 05A40	UM 08240	UM 12240
33	UM 00A50	UM 03250	UM 05A50	UM 08250	UM 12250
34	UM 00A60	UM 03260	UM 05A60	UM 08260	UM 12260
35	UM 00A70	UM 03270	UM 05A70	UM 08270	UM 12270
36	UM 00A80	UM 03280	UM 05A80	UM 08280	UM 12280
37	UM 00A90	UM 03290	UM 05A90	UM 08290	UM 12290
38	UM 00AA0	UM 032A0	UM 05AA0	UM 082A0	UM 122A0
39	UM 00AB0	UM 032B0	UM 05AB0	UM 082B0	UM 122B0
40	UM 00AC0	UM 032C0	UM 05AC0	UM 082C0	UM 122C0

17.6 Details of Each Axis Setting Area in Unit Memory

Table no.	1st axis	2nd axis	3rd axis	4th axis	Virtual axis
41	UM 00AD0	UM 032D0	UM 05AD0	UM 082D0	UM 122D0
42	UM 00AE0	UM 032E0	UM 05AE0	UM 082E0	UM 122E0
43	UM 00AF0	UM 032F0	UM 05AF0	UM 082F0	UM 122F0
44	UM 00B00	UM 03300	UM 05B00	UM 08300	UM 12300
45	UM 00B10	UM 03310	UM 05B10	UM 08310	UM 12310
46	UM 00B20	UM 03320	UM 05B20	UM 08320	UM 12320
47	UM 00B30	UM 03330	UM 05B30	UM 08330	UM 12330
48	UM 00B40	UM 03340	UM 05B40	UM 08340	UM 12340
49	UM 00B50	UM 03350	UM 05B50	UM 08350	UM 12350
50	UM 00B60	UM 03360	UM 05B60	UM 08360	UM 12360
51	UM 00B70	UM 03370	UM 05B70	UM 08370	UM 12370
52	UM 00B80	UM 03380	UM 05B80	UM 08380	UM 12380
53	UM 00B90	UM 03390	UM 05B90	UM 08390	UM 12390
54	UM 00BA0	UM 033A0	UM 05BA0	UM 083A0	UM 123A0
55	UM 00BB0	UM 033B0	UM 05BB0	UM 083B0	UM 123B0
56	UM 00BC0	UM 033C0	UM 05BC0	UM 083C0	UM 123C0
57	UM 00BD0	UM 033D0	UM 05BD0	UM 083D0	UM 123D0
58	UM 00BE0	UM 033E0	UM 05BE0	UM 083E0	UM 123E0
59	UM 00BF0	UM 033F0	UM 05BF0	UM 083F0	UM 123F0
60	UM 00C00	UM 03400	UM 05C00	UM 08400	UM 12400
61	UM 00C10	UM 03410	UM 05C10	UM 08410	UM 12410
62	UM 00C20	UM 03420	UM 05C20	UM 08420	UM 12420
63	UM 00C30	UM 03430	UM 05C30	UM 08430	UM 12430
64	UM 00C40	UM 03440	UM 05C40	UM 08440	UM 12440
65	UM 00C50	UM 03450	UM 05C50	UM 08450	UM 12450
66	UM 00C60	UM 03460	UM 05C60	UM 08460	UM 12460
67	UM 00C70	UM 03470	UM 05C70	UM 08470	UM 12470
68	UM 00C80	UM 03480	UM 05C80	UM 08480	UM 12480
69	UM 00C90	UM 03490	UM 05C90	UM 08490	UM 12490
70	UM 00CA0	UM 034A0	UM 05CA0	UM 084A0	UM 124A0
71	UM 00CB0	UM 034B0	UM 05CB0	UM 084B0	UM 124B0
72	UM 00CC0	UM 034C0	UM 05CC0	UM 084C0	UM 124C0
73	UM 00CD0	UM 034D0	UM 05CD0	UM 084D0	UM 124D0
74	UM 00CE0	UM 034E0	UM 05CE0	UM 084E0	UM 124E0
75	UM 00CF0	UM 034F0	UM 05CF0	UM 084F0	UM 124F0
76	UM 00D00	UM 03500	UM 05D00	UM 08500	UM 12500
77	UM 00D10	UM 03510	UM 05D10	UM 08510	UM 12510
78	UM 00D20	UM 03520	UM 05D20	UM 08520	UM 12520
79	UM 00D30	UM 03530	UM 05D30	UM 08530	UM 12530
80	UM 00D40	UM 03540	UM 05D40	UM 08540	UM 12540

Specifications

Table no.	1st axis	2nd axis	3rd axis	4th axis	Virtual axis
81	UM 00D50	UM 03550	UM 05D50	UM 08550	UM 12550
82	UM 00D60	UM 03560	UM 05D60	UM 08560	UM 12560
83	UM 00D70	UM 03570	UM 05D70	UM 08570	UM 12570
84	UM 00D80	UM 03580	UM 05D80	UM 08580	UM 12580
85	UM 00D90	UM 03590	UM 05D90	UM 08590	UM 12590
86	UM 00DA0	UM 035A0	UM 05DA0	UM 085A0	UM 125A0
87	UM 00DB0	UM 035B0	UM 05DB0	UM 085B0	UM 125B0
88	UM 00DC0	UM 035C0	UM 05DC0	UM 085C0	UM 125C0
89	UM 00DD0	UM 035D0	UM 05DD0	UM 085D0	UM 125D0
90	UM 00DE0	UM 035E0	UM 05DE0	UM 085E0	UM 125E0
91	UM 00DF0	UM 035F0	UM 05DF0	UM 085F0	UM 125F0
92	UM 00E00	UM 03600	UM 05E00	UM 08600	UM 12600
93	UM 00E10	UM 03610	UM 05E10	UM 08610	UM 12610
94	UM 00E20	UM 03620	UM 05E20	UM 08620	UM 12620
95	UM 00E30	UM 03630	UM 05E30	UM 08630	UM 12630
96	UM 00E40	UM 03640	UM 05E40	UM 08640	UM 12640
97	UM 00E50	UM 03650	UM 05E50	UM 08650	UM 12650
98	UM 00E60	UM 03660	UM 05E60	UM 08660	UM 12660
99	UM 00E70	UM 03670	UM 05E70	UM 08670	UM 12670
100	UM 00E80	UM 03680	UM 05E80	UM 08680	UM 12680
101	UM 00E90	UM 03690	UM 05E90	UM 08690	UM 12690
102	UM 00EA0	UM 036A0	UM 05EA0	UM 086A0	UM 126A0
103	UM 00EB0	UM 036B0	UM 05EB0	UM 086B0	UM 126B0
104	UM 00EC0	UM 036C0	UM 05EC0	UM 086C0	UM 126C0
105	UM 00ED0	UM 036D0	UM 05ED0	UM 086D0	UM 126D0
106	UM 00EE0	UM 036E0	UM 05EE0	UM 086E0	UM 126E0
107	UM 00EF0	UM 036F0	UM 05EF0	UM 086F0	UM 126F0
108	UM 00F00	UM 03700	UM 05F00	UM 08700	UM 12700
109	UM 00F10	UM 03710	UM 05F10	UM 08710	UM 12710
110	UM 00F20	UM 03720	UM 05F20	UM 08720	UM 12720
111	UM 00F30	UM 03730	UM 05F30	UM 08730	UM 12730
112	UM 00F40	UM 03740	UM 05F40	UM 08740	UM 12740
113	UM 00F50	UM 03750	UM 05F50	UM 08750	UM 12750
114	UM 00F60	UM 03760	UM 05F60	UM 08760	UM 12760
115	UM 00F70	UM 03770	UM 05F70	UM 08770	UM 12770
116	UM 00F80	UM 03780	UM 05F80	UM 08780	UM 12780
117	UM 00F90	UM 03790	UM 05F90	UM 08790	UM 12790
118	UM 00FA0	UM 037A0	UM 05FA0	UM 087A0	UM 127A0
119	UM 00FB0	UM 037B0	UM 05FB0	UM 087B0	UM 127B0
120	UM 00FC0	UM 037C0	UM 05FC0	UM 087C0	UM 127C0

17.6 Details of Each Axis Setting Area in Unit Memory

Table no.	1st axis	2nd axis	3rd axis	4th axis	Virtual axis
121	UM 00FD0	UM 037D0	UM 05FD0	UM 087D0	UM 127D0
122	UM 00FE0	UM 037E0	UM 05FE0	UM 087E0	UM 127E0
123	UM 00FF0	UM 037F0	UM 05FF0	UM 087F0	UM 127F0
124	UM 01000	UM 03800	UM 06000	UM 08800	UM 12800
125	UM 01010	UM 03810	UM 06010	UM 08810	UM 12810
126	UM 01020	UM 03820	UM 06020	UM 08820	UM 12820
127	UM 01030	UM 03830	UM 06030	UM 08830	UM 12830
128	UM 01040	UM 03840	UM 06040	UM 08840	UM 12840
129	UM 01050	UM 03850	UM 06050	UM 08850	UM 12850
130	UM 01060	UM 03860	UM 06060	UM 08860	UM 12860
131	UM 01070	UM 03870	UM 06070	UM 08870	UM 12870
132	UM 01080	UM 03880	UM 06080	UM 08880	UM 12880
133	UM 01090	UM 03890	UM 06090	UM 08890	UM 12890
134	UM 010A0	UM 038A0	UM 060A0	UM 088A0	UM 128A0
135	UM 010B0	UM 038B0	UM 060B0	UM 088B0	UM 128B0
136	UM 010C0	UM 038C0	UM 060C0	UM 088C0	UM 128C0
137	UM 010D0	UM 038D0	UM 060D0	UM 088D0	UM 128D0
138	UM 010E0	UM 038E0	UM 060E0	UM 088E0	UM 128E0
139	UM 010F0	UM 038F0	UM 060F0	UM 088F0	UM 128F0
140	UM 01100	UM 03900	UM 06100	UM 08900	UM 12900
141	UM 01110	UM 03910	UM 06110	UM 08910	UM 12910
142	UM 01120	UM 03920	UM 06120	UM 08920	UM 12920
143	UM 01130	UM 03930	UM 06130	UM 08930	UM 12930
144	UM 01140	UM 03940	UM 06140	UM 08940	UM 12940
145	UM 01150	UM 03950	UM 06150	UM 08950	UM 12950
146	UM 01160	UM 03960	UM 06160	UM 08960	UM 12960
147	UM 01170	UM 03970	UM 06170	UM 8970	UM 12970
148	UM 01180	UM 03980	UM 06180	UM 08980	UM 12980
149	UM 01190	UM 03990	UM 06190	UM 08990	UM 12990
150	UM 011A0	UM 039A0	UM 061A0	UM 089A0	UM 129A0
151	UM 011B0	UM 039B0	UM 061B0	UM 089B0	UM 129B0
152	UM 011C0	UM 039C0	UM 061C0	UM 089C0	UM 129C0
153	UM 011D0	UM 039D0	UM061D0	UM 089D0	UM 129D0
154	UM 011E0	UM 039E0	UM 061E0	UM 089E0	UM 129E0
155	UM 011F0	UM 039F0	UM 061F0	UM 089F0	UM 129F0
156	UM 01200	UM 03A00	UM 06200	UM 08A00	UM 12A00
157	UM 01210	UM 03A10	UM 06210	UM 08A10	UM 12A10
158	UM 01220	UM 03A20	UM 06220	UM 08A20	UM 12A20
159	UM 01230	UM 03A30	UM 06230	UM 08A30	UM 12A30
160	UM 01240	UM 03A40	UM 06240	UM 08A40	UM 12A40

Specifications

Table no.	1st axis	2nd axis	3rd axis	4th axis	Virtual axis
161	UM 01250	UM 03A50	UM 06250	UM 08A50	UM 12A50
162	UM 01260	UM 03A60	UM 06260	UM 08A60	UM 12A60
163	UM 01270	UM 03A70	UM 06270	UM 08A70	UM 12A70
164	UM 01280	UM 03A80	UM 06280	UM 08A80	UM 12A80
165	UM 01290	UM 03A90	UM 06290	UM 08A90	UM 12A90
166	UM 012A0	UM 03AA0	UM 062A0	UM 08AA0	UM 12AA0
167	UM 012B0	UM 03AB0	UM 062B0	UM 08AB0	UM 12AB0
168	UM 012C0	UM 03AC0	UM 062C0	UM 08AC0	UM 12AC0
169	UM 012D0	UM 03AD0	UM 062D0	UM 08AD0	UM 12AD0
170	UM 012E0	UM 03AE0	UM 062E0	UM 08AE0	UM 12AE0
171	UM 012F0	UM 03AF0	UM 062F0	UM 08AF0	UM 12AF0
172	UM 01300	UM 03B00	UM 06300	UM 08B00	UM 12B00
173	UM 01310	UM 03B10	UM 06310	UM 08B10	UM 12B10
174	UM 01320	UM 03B20	UM 06320	UM 08B20	UM 12B20
175	UM 01330	UM 03B30	UM 06330	UM 08B30	UM 12B30
176	UM 01340	UM 03B40	UM 06340	UM 08B40	UM 12B40
177	UM 01350	UM 03B50	UM 06350	UM 08B50	UM 12B50
178	UM 01360	UM 03B60	UM 06360	UM 08B60	UM 12B60
179	UM 01370	UM 03B70	UM 06370	UM 08B70	UM 12B70
180	UM 01380	UM 03B80	UM 06380	UM 08B80	UM 12B80
181	UM 01390	UM 03B90	UM 06390	UM 08B90	UM 12B90
182	UM 013A0	UM 03BA0	UM 063A0	UM 08BA0	UM 12BA0
183	UM 013B0	UM 03BB0	UM 063B0	UM 08BB0	UM 12BB0
184	UM 013C0	UM 03BC0	UM 063C0	UM 08BC0	UM 12BC0
185	UM 013D0	UM 03BD0	UM 063D0	UM 08BD0	UM 12BD0
186	UM 013E0	UM 03BE0	UM 063E0	UM 08BE0	UM 12BE0
187	UM 013F0	UM 03BF0	UM 063F0	UM 08BF0	UM 12BF0
188	UM 01400	UM 03C00	UM 06400	UM 08C00	UM 12C00
189	UM 01410	UM 03C10	UM 06410	UM 08C10	UM 12C10
190	UM 01420	UM 03C20	UM 06420	UM 08C20	UM 12C20
191	UM 01430	UM 03C30	UM 06430	UM 08C30	UM 12C30
192	UM 01440	UM 03C40	UM 06440	UM 08C40	UM 12C40
193	UM 01450	UM 03C50	UM 06450	UM 08C50	UM 12C50
194	UM 01460	UM 03C60	UM 06460	UM 08C60	UM 12C60
195	UM 01470	UM 03C70	UM 06470	UM 08C70	UM 12C70
196	UM 01480	UM 03C80	UM 06480	UM 08C80	UM 12C80
197	UM 01490	UM 03C90	UM 06490	UM 08C90	UM 12C90
198	UM 014A0	UM 03CA0	UM 064A0	UM 08CA0	UM 12CA0
199	UM 014B0	UM 03CB0	UM 064B0	UM 08CB0	UM 12CB0
200	UM 014C0	UM 03CC0	UM 064C0	UM 08CC0	UM 12CC0

17.6 Details of Each Axis Setting Area in Unit Memory

Table no.	1st axis	2nd axis	3rd axis	4th axis	Virtual axis
201	UM 014D0	UM 03CD0	UM 064D0	UM 08CD0	UM 12CD0
202	UM 014E0	UM 03CE0	UM 064E0	UM 08CE0	UM 12CE0
203	UM 014F0	UM 03CF0	UM 064F0	UM 08CF0	UM 12CF0
204	UM 01500	UM 03D00	UM 06500	UM 08D00	UM 12D00
205	UM 01510	UM 03D10	UM 06510	UM 08D10	UM 12D10
206	UM 01520	UM 03D20	UM 06520	UM 08D20	UM 12D20
207	UM 01530	UM 03D30	UM 06530	UM 08D30	UM 12D30
208	UM 01540	UM 03D40	UM 06540	UM 08D40	UM 12D40
209	UM 01550	UM 03D50	UM 06550	UM 08D50	UM 12D50
210	UM 01560	UM 03D60	UM 06560	UM 08D60	UM 12D60
211	UM 01570	UM 03D70	UM 06570	UM 08D70	UM 12D70
212	UM 01580	UM 03D80	UM 06580	UM 08D80	UM 12D80
213	UM 01590	UM 03D90	UM 06590	UM 08D90	UM 12D90
214	UM 015A0	UM 03DA0	UM 065A0	UM 08DA0	UM 12DA0
215	UM 015B0	UM 03DB0	UM 065B0	UM 08DB0	UM 12DB0
216	UM 015C0	UM 03DC0	UM 065C0	UM 08DC0	UM 12DC0
217	UM 015D0	UM 03DD0	UM 065D0	UM 08DD0	UM 12DD0
218	UM 015E0	UM 03DE0	UM 065E0	UM 08DE0	UM 12DE0
219	UM 015F0	UM 03DF0	UM 065F0	UM 08DF0	UM 12DF0
220	UM 01600	UM 03E00	UM 06600	UM 08E00	UM 12E00
221	UM 01610	UM 03E10	UM 06610	UM 08E10	UM 12E10
222	UM 01620	UM 03E20	UM 06620	UM 08E20	UM 12E20
223	UM 01630	UM 03E30	UM 06630	UM 08E30	UM 12E30
224	UM 01640	UM 03E40	UM 06640	UM 08E40	UM 12E40
225	UM 01650	UM 03E50	UM 06650	UM 08E50	UM 12E50
226	UM 01660	UM 03E60	UM 06660	UM 08E60	UM 12E60
227	UM 01670	UM 03E70	UM 06670	UM 08E70	UM 12E70
228	UM 01680	UM 03E80	UM 06680	UM 08E80	UM 12E80
229	UM 01690	UM 03E90	UM 06690	UM 08E90	UM 12E90
230	UM 016A0	UM 03EA0	UM 066A0	UM 08EA0	UM 12EA0
231	UM 016B0	UM 03EB0	UM 066B0	UM 08EB0	UM 12EB0
232	UM 016C0	UM 03EC0	UM 066C0	UM 08EC0	UM 12EC0
233	UM 016D0	UM 03ED0	UM 066D0	UM 08ED0	UM 12ED0
234	UM 016E0	UM 03EE0	UM 066E0	UM 08EE0	UM 12EE0
235	UM 016F0	UM 03EF0	UM 066F0	UM 08EF0	UM 12EF0
236	UM 01700	UM 03F00	UM 06700	UM 08F00	UM 12F00
237	UM 01710	UM 03F10	UM 06710	UM 08F10	UM 12F10
238	UM 01720	UM 03F20	UM 06720	UM 08F20	UM 12F20
239	UM 01730	UM 03F30	UM 06730	UM 08F30	UM 12F30
240	UM 01740	UM 03F40	UM 06740	UM 08F40	UM 12F40

Specifications

Table no.	1st axis	2nd axis	3rd axis	4th axis	Virtual axis
241	UM 01750	UM 03F50	UM 06750	UM 08F50	UM 12F50
242	UM 01760	UM 03F60	UM 06760	UM 08F60	UM 12F60
243	UM 01770	UM 03F70	UM 06770	UM 08F70	UM 12F70
244	UM 01780	UM 03F80	UM 06780	UM 08F80	UM 12F80
245	UM 01790	UM 03F90	UM 06790	UM 08F90	UM 12F90
246	UM 017A0	UM 03FA0	UM 067A0	UM 08FA0	UM 12FA0
247	UM 017B0	UM 03FB0	UM 067B0	UM 08FB0	UM 12FB0
248	UM 017C0	UM 03FC0	UM 067C0	UM 08FC0	UM 12FC0
249	UM 017D0	UM 03FD0	UM 067D0	UM 08FD0	UM 12FD0
250	UM 017E0	UM 03FE0	UM 067E0	UM 08FE0	UM 12FE0
251	UM 017F0	UM 03FF0	UM 067F0	UM 08FF0	UM 12FF0
252	UM 01800	UM 04000	UM 06800	UM 09000	UM 13000
253	UM 01810	UM 04010	UM 06810	UM 09010	UM 13010
254	UM 01820	UM 04020	UM 06820	UM 09020	UM 13020
255	UM 01830	UM 04030	UM 06830	UM 09030	UM 13030
256	UM 01840	UM 04040	UM 06840	UM 09040	UM 13040
257	UM 01850	UM 04050	UM 06850	UM 09050	UM 13050
258	UM 01860	UM 04060	UM 06860	UM 09060	UM 13060
259	UM 01870	UM 04070	UM 06870	UM 09070	UM 13070
260	UM 01880	UM 04080	UM 06880	UM 09080	UM 13080
261	UM 01890	UM 04090	UM 06890	UM 09090	UM 13090
262	UM 018A0	UM 040A0	UM 068A0	UM 090A0	UM 130A0
263	UM 018B0	UM 040B0	UM 068B0	UM 090B0	UM 130B0
264	UM 018C0	UM 040C0	UM 068C0	UM 090C0	UM 130C0
265	UM 018D0	UM 040D0	UM 068D0	UM 090D0	UM 130D0
266	UM 018E0	UM 040E0	UM 068E0	UM 090E0	UM 130E0
267	UM 018F0	UM 040F0	UM 068F0	UM 090F0	UM 130F0
268	UM 01900	UM 04100	UM 06900	UM 09100	UM 13100
269	UM 01910	UM 04110	UM 06910	UM 09110	UM 13110
270	UM 01920	UM 04120	UM 06920	UM 09120	UM 13120
271	UM 01930	UM 04130	UM 06930	UM 09130	UM 13130
272	UM 01940	UM 04140	UM 06940	UM 09140	UM 13140
273	UM 01950	UM 04150	UM 06950	UM 09150	UM 13150
274	UM 01960	UM 04160	UM 06960	UM 09160	UM 13160
275	UM 01970	UM 04170	UM 06970	UM 09170	UM 13170
276	UM 01980	UM 04180	UM 06980	UM 09180	UM 13180
277	UM 01990	UM 04190	UM 06990	UM 09190	UM 13190
278	UM 019A0	UM 041A0	UM 069A0	UM 091A0	UM 131A0
279	UM 019B0	UM 041B0	UM 069B0	UM 091B0	UM 131B0
280	UM 019C0	UM 041C0	UM 069C0	UM 091C0	UM 131C0

17.6 Details of Each Axis Setting Area in Unit Memory

Table no.	1st axis	2nd axis	3rd axis	4th axis	Virtual axis
281	UM 019D0	UM 041D0	UM 069D0	UM 091D0	UM 131D0
282	UM 019E0	UM 041E0	UM 069E0	UM 091E0	UM 131E0
283	UM 019F0	UM 041F0	UM 069F0	UM 091F0	UM 131F0
284	UM 01A00	UM 04200	UM 06A00	UM 09200	UM 13200
285	UM 01A10	UM 04210	UM 06A10	UM 09210	UM 13210
286	UM 01A20	UM 04220	UM 06A20	UM 09220	UM 13220
287	UM 01A30	UM 04230	UM 06A30	UM 09230	UM 13230
288	UM 01A40	UM 04240	UM 06A40	UM 09240	UM 13240
289	UM 01A50	UM 04250	UM 06A50	UM 09250	UM 13250
290	UM 01A60	UM 04260	UM 06A60	UM 09260	UM 13260
291	UM 01A70	UM 04270	UM 06A70	UM 09270	UM 13270
292	UM 01A80	UM 04280	UM 06A80	UM 09280	UM 13280
293	UM 01A90	UM 04290	UM 06A90	UM 09290	UM 13290
294	UM 01AA0	UM 042A0	UM 06AA0	UM 092A0	UM 132A0
295	UM 01AB0	UM 042B0	UM 06AB0	UM 092B0	UM 132B0
296	UM 01AC0	UM 042C0	UM 06AC0	UM 092C0	UM 132C0
297	UM 01AD0	UM 042D0	UM 06AD0	UM 092D0	UM 132D0
298	UM 01AE0	UM 042E0	UM 06AE0	UM 092E0	UM 132E0
299	UM 01AF0	UM 042F0	UM 06AF0	UM 092F0	UM 132F0
300	UM 01B00	UM 04300	UM 06B00	UM 09300	UM 13300
301	UM 01B10	UM 04310	UM 06B10	UM 09310	UM 13310
302	UM 01B20	UM 04320	UM 06B20	UM 09320	UM 13320
303	UM 01B30	UM 04330	UM 06B30	UM 09330	UM 13330
304	UM 01B40	UM 04340	UM 06B40	UM 09340	UM 13340
305	UM 01B50	UM 04350	UM 06B50	UM 09350	UM 13350
306	UM 01B60	UM 04360	UM 06B60	UM 09360	UM 13360
307	UM 01B70	UM 04370	UM 06B70	UM 09370	UM 13370
308	UM 01B80	UM 04380	UM 06B80	UM 09380	UM 13380
309	UM 01B90	UM 04390	UM 06B90	UM 09390	UM 13390
310	UM 01BA0	UM 043A0	UM 06BA0	UM 093A0	UM 133A0
311	UM 01BB0	UM 043B0	UM 06BB0	UM 093B0	UM 133B0
312	UM 01BC0	UM 043C0	UM 06BC0	UM 093C0	UM 133C0
313	UM 01BD0	UM 043D0	UM 06BD0	UM 093D0	UM 133D0
314	UM 01BE0	UM 043E0	UM 06BE0	UM 093E0	UM 133E0
315	UM 01BF0	UM 043F0	UM 06BF0	UM 093F0	UM 133F0
316	UM 01C00	UM 04400	UM 06C00	UM 09400	UM 13400
317	UM 01C10	UM 04410	UM 06C10	UM 09410	UM 13410
318	UM 01C20	UM 04420	UM 06C20	UM 09420	UM 13420
319	UM 01C30	UM 04430	UM 06C30	UM 09430	UM 13430
320	UM 01C40	UM 04440	UM 06C40	UM 09440	UM 13440

Specifications

Table no.	1st axis	2nd axis	3rd axis	4th axis	Virtual axis
321	UM 01C50	UM 04450	UM 06C50	UM 09450	UM 13450
322	UM 01C60	UM 04460	UM 06C60	UM 09460	UM 13460
323	UM 01C70	UM 04470	UM 06C70	UM 09470	UM 13470
324	UM 01C80	UM 04480	UM 06C80	UM 09480	UM 13480
325	UM 01C90	UM 04490	UM 06C90	UM 09490	UM 13490
326	UM 01CA0	UM 044A0	UM 06CA0	UM 094A0	UM 134A0
327	UM 01CB0	UM 044B0	UM 06CB0	UM 094B0	UM 134B0
328	UM 01CC0	UM 044C0	UM 06CC0	UM 094C0	UM 134C0
329	UM 01CD0	UM 044D0	UM 06CD0	UM 094D0	UM 134D0
330	UM 01CE0	UM 044E0	UM 06CE0	UM 094E0	UM 134E0
331	UM 01CF0	UM 044F0	UM 06CF0	UM 094F0	UM 134F0
332	UM 01D00	UM 04500	UM 06D00	UM 09500	UM 13500
333	UM 01D10	UM 04510	UM 06D10	UM 09510	UM 13510
334	UM 01D20	UM 04520	UM 06D20	UM 09520	UM 13520
335	UM 01D30	UM 04530	UM 06D30	UM 09530	UM 13530
336	UM 01D40	UM 04540	UM 06D40	UM 09540	UM 13540
337	UM 01D50	UM 04550	UM 06D50	UM 09550	UM 13550
338	UM 01D60	UM 04560	UM 06D60	UM 09560	UM 13560
339	UM 01D70	UM 04570	UM 06D70	UM 09570	UM 13570
340	UM 01D80	UM 04580	UM 06D80	UM 09580	UM 13580
341	UM 01D90	UM 04590	UM 06D90	UM 09590	UM 13590
342	UM 01DA0	UM 045A0	UM 06DA0	UM 095A0	UM 135A0
343	UM 01DB0	UM 045B0	UM 06DB0	UM 095B0	UM 135B0
344	UM 01DC0	UM 045C0	UM 06DC0	UM 095C0	UM 135C0
345	UM 01DD0	UM 045D0	UM 06DD0	UM 095D0	UM 135D0
346	UM 01DE0	UM 045E0	UM 06DE0	UM 095E0	UM 135E0
347	UM 01DF0	UM 045F0	UM 06DF0	UM 095F0	UM 135F0
348	UM 01E00	UM 04600	UM 06E00	UM 09600	UM 13600
349	UM 01E10	UM 04610	UM 06E10	UM 09610	UM 13610
350	UM 01E20	UM 04620	UM 06E20	UM 09620	UM 13620
351	UM 01E30	UM 04630	UM 06E30	UM 09630	UM 13630
352	UM 01E40	UM 04640	UM 06E40	UM 09640	UM 13640
353	UM 01E50	UM 04650	UM 06E50	UM 09650	UM 13650
354	UM 01E60	UM 04660	UM 06E60	UM 09660	UM 13660
355	UM 01E70	UM 04670	UM 06E70	UM 09670	UM 13670
356	UM 01E80	UM 04680	UM 06E80	UM 09680	UM 13680
357	UM 01E90	UM 04690	UM 06E90	UM 09690	UM 13690
358	UM 01EA0	UM 046A0	UM 06EA0	UM 096A0	UM 136A0
359	UM 01EB0	UM 046B0	UM 06EB0	UM 096B0	UM 136B0
360	UM 01EC0	UM 046C0	UM 06EC0	UM 096C0	UM 136C0

17.6 Details of Each Axis Setting Area in Unit Memory

Table no.	1st axis	2nd axis	3rd axis	4th axis	Virtual axis
361	UM 01ED0	UM 046D0	UM 06ED0	UM 096D0	UM 136D0
362	UM 01EE0	UM 046E0	UM 06EE0	UM 096E0	UM 136E0
363	UM 01EF0	UM 046F0	UM 06EF0	UM 096F0	UM 136F0
364	UM 01F00	UM 04700	UM 06F00	UM 09700	UM 13700
365	UM 01F10	UM 04710	UM 06F10	UM 09710	UM 13710
366	UM 01F20	UM 04720	UM 06F20	UM 09720	UM 13720
367	UM 01F30	UM 04730	UM 06F30	UM 09730	UM 13730
368	UM 01F40	UM 04740	UM 06F40	UM 09740	UM 13740
369	UM 01F50	UM 04750	UM 06F50	UM 09750	UM 13750
370	UM 01F60	UM 04760	UM 06F60	UM 09760	UM 13760
371	UM 01F70	UM 04770	UM 06F70	UM 09770	UM 13770
372	UM 01F80	UM 04780	UM 06F80	UM 09780	UM 13780
373	UM 01F90	UM 04790	UM 06F90	UM 09790	UM 13790
374	UM 01FA0	UM 047A0	UM 06FA0	UM 097A0	UM 137A0
375	UM 01FB0	UM 047B0	UM 06FB0	UM 097B0	UM 137B0
376	UM 01FC0	UM 047C0	UM 06FC0	UM 097C0	UM 137C0
377	UM 01FD0	UM 047D0	UM 06FD0	UM 097D0	UM 137D0
378	UM 01FE0	UM 047E0	UM 06FE0	UM 097E0	UM 137E0
379	UM 01FF0	UM 047F0	UM 06FF0	UM 097F0	UM 137F0
380	UM 02000	UM 04800	UM 07000	UM 09800	UM 13800
381	UM 02010	UM 04810	UM 07010	UM 09810	UM 13810
382	UM 02020	UM 04820	UM 07020	UM 09820	UM 13820
383	UM 02030	UM 04830	UM 07030	UM 09830	UM 13830
384	UM 02040	UM 04840	UM 07040	UM 09840	UM 13840
385	UM 02050	UM 04850	UM 07050	UM 09850	UM 13850
386	UM 02060	UM 04860	UM 07060	UM 09860	UM 13860
387	UM 02070	UM 04870	UM 07070	UM 09870	UM 13870
388	UM 02080	UM 04880	UM 07080	UM 09880	UM 13880
389	UM 02090	UM 04890	UM 07090	UM 09890	UM 13890
390	UM 020A0	UM 048A0	UM 070A0	UM 098A0	UM 138A0
391	UM 020B0	UM 048B0	UM 070B0	UM 098B0	UM 138B0
392	UM 020C0	UM 048C0	UM 070C0	UM 098C0	UM 138C0
393	UM 020D0	UM 048D0	UM 070D0	UM 098D0	UM 138D0
394	UM 020E0	UM 048E0	UM 070E0	UM 098E0	UM 138E0
395	UM 020F0	UM 048F0	UM 070F0	UM 098F0	UM 138F0
396	UM 02100	UM 04900	UM 07100	UM 09900	UM 13900
397	UM 02110	UM 04910	UM 07110	UM 09910	UM 13910
398	UM 02120	UM 04920	UM 07120	UM 09920	UM 13920
399	UM 02130	UM 04930	UM 07130	UM 09930	UM 13930
400	UM 02140	UM 04940	UM 07140	UM 09940	UM 13940

Specifications

Table no.	1st axis	2nd axis	3rd axis	4th axis	Virtual axis
401	UM 02150	UM 04950	UM 07150	UM 09950	UM 13950
402	UM 02160	UM 04960	UM 07160	UM 09960	UM 13960
403	UM 02170	UM 04970	UM 07170	UM 09970	UM 13970
404	UM 02180	UM 04980	UM 07180	UM 09980	UM 13980
405	UM 02190	UM 04990	UM 07190	UM 09990	UM 13990
406	UM 021A0	UM 049A0	UM 071A0	UM 099A0	UM 139A0
407	UM 021B0	UM 049B0	UM 071B0	UM 099B0	UM 139B0
408	UM 021C0	UM 049C0	UM 071C0	UM 099C0	UM 139C0
409	UM 021D0	UM 049D0	UM 071D0	UM 099D0	UM 139D0
410	UM 021E0	UM 049E0	UM 071E0	UM 099E0	UM 139E0
411	UM 021F0	UM 049F0	UM 071F0	UM 099F0	UM 139F0
412	UM 02200	UM 04A00	UM 07200	UM 09A00	UM 13A00
413	UM 02210	UM 04A10	UM 07210	UM 09A10	UM 13A10
414	UM 02220	UM 04A20	UM 07220	UM 09A20	UM 13A20
415	UM 02230	UM 04A30	UM 07230	UM 09A30	UM 13A30
416	UM 02240	UM 04A40	UM 07240	UM 09A40	UM 13A40
417	UM 02250	UM 04A50	UM 07250	UM 09A50	UM 13A50
418	UM 02260	UM 04A60	UM 07260	UM 09A60	UM 13A60
419	UM 02270	UM 04A70	UM 07270	UM 09A70	UM 13A70
420	UM 02280	UM 04A80	UM 07280	UM 09A80	UM 13A80
421	UM 02290	UM 04A90	UM 07290	UM 09A90	UM 13A90
422	UM 022A0	UM 04AA0	UM 072A0	UM 09AA0	UM 13AA0
423	UM 022B0	UM 04AB0	UM 072B0	UM 09AB0	UM 13AB0
424	UM 022C0	UM 04AC0	UM 072C0	UM 09AC0	UM 13AC0
425	UM 022D0	UM 04AD0	UM 072D0	UM 09AD0	UM 13AD0
426	UM 022E0	UM 04AE0	UM 072E0	UM 09AE0	UM 13AE0
427	UM 022F0	UM 04AF0	UM 072F0	UM 09AF0	UM 13AF0
428	UM 02300	UM 04B00	UM 07300	UM 09B00	UM 13B00
429	UM 02310	UM 04B10	UM 07310	UM 09B10	UM 13B10
430	UM 02320	UM 04B20	UM 07320	UM 09B20	UM 13B20
431	UM 02330	UM 04B30	UM 07330	UM 09B30	UM 13B30
432	UM 02340	UM 04B40	UM 07340	UM 09B40	UM 13B40
433	UM 02350	UM 04B50	UM 07350	UM 09B50	UM 13B50
434	UM 02360	UM 04B60	UM 07360	UM 09B60	UM 13B60
435	UM 02370	UM 04B70	UM 07370	UM 09B70	UM 13B70
436	UM 02380	UM 04B80	UM 07380	UM 09B80	UM 13B80
437	UM 02390	UM 04B90	UM 07390	UM 09B90	UM 13B90
438	UM 023A0	UM 04BA0	UM 073A0	UM 09BA0	UM 13BA0
439	UM 023B0	UM 04BB0	UM 073B0	UM 09BB0	UM 13BB0
440	UM 023C0	UM 04BC0	UM 073C0	UM 09BC0	UM 13BC0

17.6 Details of Each Axis Setting Area in Unit Memory

Table no.	1st axis	2nd axis	3rd axis	4th axis	Virtual axis
441	UM 023D0	UM 04BD0	UM 073D0	UM 09BD0	UM 13BD0
442	UM 023E0	UM 04BE0	UM 073E0	UM 09BE0	UM 13BE0
443	UM 023F0	UM 04BF0	UM 073F0	UM 09BF0	UM 13BF0
444	UM 02400	UM 04C00	UM 07400	UM 09C00	UM 13C00
445	UM 02410	UM 04C10	UM 07410	UM 09C10	UM 13C10
446	UM 02420	UM 04C20	UM 07420	UM 09C20	UM 13C20
447	UM 02430	UM 04C30	UM 07430	UM 09C30	UM 13C30
448	UM 02440	UM 04C40	UM 07440	UM 09C40	UM 13C40
449	UM 02450	UM 04C50	UM 07450	UM 09C50	UM 13C50
450	UM 02460	UM 04C60	UM 07460	UM 09C60	UM 13C60
451	UM 02470	UM 04C70	UM 07470	UM 09C70	UM 13C70
452	UM 02480	UM 04C80	UM 07480	UM 09C80	UM 13C80
453	UM 02490	UM 04C90	UM 07490	UM 09C90	UM 13C90
454	UM 024A0	UM 04CA0	UM 074A0	UM 09CA0	UM 13CA0
455	UM 024B0	UM 04CB0	UM 074B0	UM 09CB0	UM 13CB0
456	UM 024C0	UM 04CC0	UM 074C0	UM 09CC0	UM 13CC0
457	UM 024D0	UM 04CD0	UM 074D0	UM 09CD0	UM 13CD0
458	UM 024E0	UM 04CE0	UM 074E0	UM 09CE0	UM 13CE0
459	UM 024F0	UM 04CF0	UM 074F0	UM 09CF0	UM 13CF0
460	UM 02500	UM 04D00	UM 07500	UM 09D00	UM 13D00
461	UM 02510	UM 04D10	UM 07510	UM 09D10	UM 13D10
462	UM 02520	UM 04D20	UM 07520	UM 09D20	UM 13D20
463	UM 02530	UM 04D30	UM 07530	UM 09D30	UM 13D30
464	UM 02540	UM 04D40	UM 07540	UM 09D40	UM 13D40
465	UM 02550	UM 04D50	UM 07550	UM 09D50	UM 13D50
466	UM 02560	UM 04D60	UM 07560	UM 09D60	UM 13D60
467	UM 02570	UM 04D70	UM 07570	UM 09D70	UM 13D70
468	UM 02580	UM 04D80	UM 07580	UM 09D80	UM 13D80
469	UM 02590	UM 04D90	UM 07590	UM 09D90	UM 13D90
470	UM 025A0	UM 04DA0	UM 075A0	UM 09DA0	UM 13DA0
471	UM 025B0	UM 04DB0	UM 075B0	UM 09DB0	UM 13DB0
472	UM 025C0	UM 04DC0	UM 075C0	UM 09DC0	UM 13DC0
473	UM 025D0	UM 04DD0	UM 075D0	UM 09DD0	UM 13DD0
474	UM 025E0	UM 04DE0	UM 075E0	UM 09DE0	UM 13DE0
475	UM 025F0	UM 04DF0	UM 075F0	UM 09DF0	UM 13DF0
476	UM 02600	UM 04E00	UM 07600	UM 09E00	UM 13E00
477	UM 02610	UM 04E10	UM 07610	UM 09E10	UM 13E10
478	UM 02620	UM 04E20	UM 07620	UM 09E20	UM 13E20
479	UM 02630	UM 04E30	UM 07630	UM 09E30	UM 13E30
480	UM 02640	UM 04E40	UM 07640	UM 09E40	UM 13E40

Specifications

Table no.	1st axis	2nd axis	3rd axis	4th axis	Virtual axis
481	UM 02650	UM 04E50	UM 07650	UM 09E50	UM 13E50
482	UM 02660	UM 04E60	UM 07660	UM 09E60	UM 13E60
483	UM 02670	UM 04E70	UM 07670	UM 09E70	UM 13E70
484	UM 02680	UM 04E80	UM 07680	UM 09E80	UM 13E80
485	UM 02690	UM 04E90	UM 07690	UM 09E90	UM 13E90
486	UM 026A0	UM 04EA0	UM 076A0	UM 09EA0	UM 13EA0
487	UM 026B0	UM 04EB0	UM 076B0	UM 09EB0	UM 13EB0
488	UM 026C0	UM 04EC0	UM 076C0	UM 09EC0	UM 13EC0
489	UM 026D0	UM 04ED0	UM 076D0	UM 09ED0	UM 13ED0
490	UM 026E0	UM 04EE0	UM 076E0	UM 09EE0	UM 13EE0
491	UM 026F0	UM 04EF0	UM 076F0	UM 09EF0	UM 13EF0
492	UM 02700	UM 04F00	UM 07700	UM 09F00	UM 13F00
493	UM 02710	UM 04F10	UM 07710	UM 09F10	UM 13F10
494	UM 02720	UM 04F20	UM 07720	UM 09F20	UM 13F20
495	UM 02730	UM 04F30	UM 07730	UM 09F30	UM 13F30
496	UM 02740	UM 04F40	UM 07740	UM 09F40	UM 13F40
497	UM 02750	UM 04F50	UM 07750	UM 09F50	UM 13F50
498	UM 02760	UM 04F60	UM 07760	UM 09F60	UM 13F60
499	UM 02770	UM 04F70	UM 07770	UM 09F70	UM 13F70
500	UM 02780	UM 04F80	UM 07780	UM 09F80	UM 13F80
501	UM 02790	UM 04F90	UM 07790	UM 09F90	UM 13F90
502	UM 027A0	UM 04FA0	UM 077A0	UM 09FA0	UM 13FA0
503	UM 027B0	UM 04FB0	UM 077B0	UM 09FB0	UM 13FB0
504	UM 027C0	UM 04FC0	UM 077C0	UM 09FC0	UM 13FC0
505	UM 027D0	UM 04FD0	UM 077D0	UM 09FD0	UM 13FD0
506	UM 027E0	UM 04FE0	UM 077E0	UM 09FE0	UM 13FE0
507	UM 027F0	UM 04FF0	UM 077F0	UM 09FF0	UM 13FF0
508	UM 02800	UM 05000	UM 07800	UM 0A000	UM 14000
509	UM 02810	UM 05010	UM 07810	UM 0A010	UM 14010
510	UM 02820	UM 05020	UM 07820	UM 0A020	UM 14020
511	UM 02830	UM 05030	UM 07830	UM 0A030	UM 14030
512	UM 02840	UM 05040	UM 07840	UM 0A040	UM 14040
513	UM 02850	UM 05050	UM 07850	UM 0A050	UM 14050
514	UM 02860	UM 05060	UM 07860	UM 0A060	UM 14060
515	UM 02870	UM 05070	UM 07870	UM 0A070	UM 14070
516	UM 02880	UM 05080	UM 07880	UM 0A080	UM 14080
517	UM 02890	UM 05090	UM 07890	UM 0A090	UM 14090
518	UM 028A0	UM 050A0	UM 078A0	UM 0A0A0	UM 140A0
519	UM 028B0	UM 050B0	UM 078B0	UM 0A0B0	UM 140B0
520	UM 028C0	UM 050C0	UM 078C0	UM 0A0C0	UM 140C0

17.6 Details of Each Axis Setting Area in Unit Memory

Table no.	1st axis	2nd axis	3rd axis	4th axis	Virtual axis
521	UM 028D0	UM 050D0	UM 078D0	UM 0A0D0	UM 140D0
522	UM 028E0	UM 050E0	UM 078E0	UM 0A0E0	UM 140E0
523	UM 028F0	UM 050F0	UM 078F0	UM 0A0F0	UM 140F0
524	UM 02900	UM 05100	UM 07900	UM 0A100	UM 14100
525	UM 02910	UM 05110	UM 07910	UM 0A110	UM 14110
526	UM 02920	UM 05120	UM 07920	UM 0A120	UM 14120
527	UM 02930	UM 05130	UM 07930	UM 0A130	UM 14130
528	UM 02940	UM 05140	UM 07940	UM 0A140	UM 14140
529	UM 02950	UM 05150	UM 07950	UM 0A150	UM 14150
530	UM 02960	UM 05160	UM 07960	UM 0A160	UM 14160
531	UM 02970	UM 05170	UM 07970	UM 0A170	UM 14170
532	UM 02980	UM 05180	UM 07980	UM 0A180	UM 14180
533	UM 02990	UM 05190	UM 07990	UM 0A190	UM 14190
534	UM 029A0	UM 051A0	UM 079A0	UM 0A1A0	UM 141A0
535	UM 029B0	UM 051B0	UM 079B0	UM 0A1B0	UM 141B0
536	UM 029C0	UM 051C0	UM 079C0	UM 0A1C0	UM 141C0
537	UM 029D0	UM 051D0	UM 079D0	UM 0A1D0	UM 141D0
538	UM 029E0	UM 051E0	UM 079E0	UM 0A1E0	UM 141E0
539	UM 029F0	UM 051F0	UM 079F0	UM 0A1F0	UM 141F0
540	UM 02A00	UM 05200	UM 07A00	UM 0A200	UM 14200
541	UM 02A10	UM 05210	UM 07A10	UM 0A210	UM 14210
542	UM 02A20	UM 05220	UM 07A20	UM 0A220	UM 14220
543	UM 02A30	UM 05230	UM 07A30	UM 0A230	UM 14230
544	UM 02A40	UM 05240	UM 07A40	UM 0A240	UM 14240
545	UM 02A50	UM 05250	UM 07A50	UM 0A250	UM 14250
546	UM 02A60	UM 05260	UM 07A60	UM 0A260	UM 14260
547	UM 02A70	UM 05270	UM 07A70	UM 0A270	UM 14270
548	UM 02A80	UM 05280	UM 07A80	UM 0A280	UM 14280
549	UM 02A90	UM 05290	UM 07A90	UM 0A290	UM 14290
550	UM 02AA0	UM 052A0	UM 07AA0	UM 0A2A0	UM 142A0
551	UM 02AB0	UM 052B0	UM 07AB0	UM 0A2B0	UM 142B0
552	UM 02AC0	UM 052C0	UM 07AC0	UM 0A2C0	UM 142C0
553	UM 02AD0	UM 052D0	UM 07AD0	UM 0A2D0	UM 142D0
554	UM 02AE0	UM 052E0	UM 07AE0	UM 0A2E0	UM 142E0
555	UM 02AF0	UM 052F0	UM 07AF0	UM 0A2F0	UM 142F0
556	UM 02B00	UM 05300	UM 07B00	UM 0A300	UM 14300
557	UM 02B10	UM 05310	UM 07B10	UM 0A310	UM 14310
558	UM 02B20	UM 05320	UM 07B20	UM 0A320	UM 14320
559	UM 02B30	UM 05330	UM 07B30	UM 0A330	UM 14330
560	UM 02B40	UM 05340	UM 07B40	UM 0A340	UM 14340

Specifications

Table no.	1st axis	2nd axis	3rd axis	4th axis	Virtual axis
561	UM 02B50	UM 05350	UM 07B50	UM 0A350	UM 14350
562	UM 02B60	UM 05360	UM 07B60	UM 0A360	UM 14360
563	UM 02B70	UM 05370	UM 07B70	UM 0A370	UM 14370
564	UM 02B80	UM 05380	UM 07B80	UM 0A380	UM 14380
565	UM 02B90	UM 05390	UM 07B90	UM 0A390	UM 14390
566	UM 02BA0	UM 053A0	UM 07BA0	UM 0A3A0	UM 143A0
567	UM 02BB0	UM 053B0	UM 07BB0	UM 0A3B0	UM 143B0
568	UM 02BC0	UM 053C0	UM 07BC0	UM 0A3C0	UM 143C0
569	UM 02BD0	UM 053D0	UM 07BD0	UM 0A3D0	UM 143D0
570	UM 02BE0	UM 053E0	UM 07BE0	UM 0A3E0	UM 143E0
571	UM 02BF0	UM 053F0	UM 07BF0	UM 0A3F0	UM 143F0
572	UM 02C00	UM 05400	UM 07C00	UM 0A400	UM 14400
573	UM 02C10	UM 05410	UM 07C10	UM 0A410	UM 14410
574	UM 02C20	UM 05420	UM 07C20	UM 0A420	UM 14420
575	UM 02C30	UM 05430	UM 07C30	UM 0A430	UM 14430
576	UM 02C40	UM 05440	UM 07C40	UM 0A440	UM 14440
577	UM 02C50	UM 05450	UM 07C50	UM 0A450	UM 14450
578	UM 02C60	UM 05460	UM 07C60	UM 0A460	UM 14460
579	UM 02C70	UM 05470	UM 07C70	UM 0A470	UM 14470
580	UM 02C80	UM 05480	UM 07C80	UM 0A480	UM 14480
581	UM 02C90	UM 05490	UM 07C90	UM 0A490	UM 14490
582	UM 02CA0	UM 054A0	UM 07CA0	UM 0A4A0	UM 144A0
583	UM 02CB0	UM 054B0	UM 07CB0	UM 0A4B0	UM 144B0
584	UM 02CC0	UM 054C0	UM 07CC0	UM 0A4C0	UM 144C0
585	UM 02CD0	UM 054D0	UM 07CD0	UM 0A4D0	UM 144D0
586	UM 02CE0	UM 054E0	UM 07CE0	UM 0A4E0	UM 144E0
587	UM 02CF0	UM 054F0	UM 07CF0	UM 0A4F0	UM 144F0
588	UM 02D00	UM 05500	UM 07D00	UM 0A500	UM 14500
589	UM 02D10	UM 05510	UM 07D10	UM 0A510	UM 14510
590	UM 02D20	UM 05520	UM 07D20	UM 0A520	UM 14520
591	UM 02D30	UM 05530	UM 07D30	UM 0A530	UM 14530
592	UM 02D40	UM 05540	UM 07D40	UM 0A540	UM 14540
593	UM 02D50	UM 05550	UM 07D50	UM 0A550	UM 14550
594	UM 02D60	UM 05560	UM 07D60	UM 0A560	UM 14560
595	UM 02D70	UM 05570	UM 07D70	UM 0A570	UM 14570
596	UM 02D80	UM 05580	UM 07D80	UM 0A580	UM 14580
597	UM 02D90	UM 05590	UM 07D90	UM 0A590	UM 14590
598	UM 02DA0	UM 055A0	UM 07DA0	UM 0A5A0	UM 145A0
599	UM 02DB0	UM 055B0	UM 07DB0	UM 0A5B0	UM 145B0
600	UM 02DC0	UM 055C0	UM 07DC0	UM 0A5C0	UM 145C0

■ **First address of each positioning table (Expansion area: 10001 to 100025)**

Table no.	1st axis	2nd axis	3rd axis	4th axis	Virtual axis
10001	UM 02E70	UM 05670	UM 07E70	UM 0A670	UM 14670
10002	UM 02E80	UM 05680	UM 07E80	UM 0A680	UM 14680
10003	UM 02E90	UM 05690	UM 07E90	UM 0A690	UM 14690
10004	UM 02EA0	UM 056A0	UM 07EA0	UM 0A6A0	UM 146A0
10005	UM 02EB0	UM 056B0	UM 07EB0	UM 0A6B0	UM 146B0
10006	UM 02EC0	UM 056C0	UM 07EC0	UM 0A6C0	UM 146C0
10007	UM 02ED0	UM 056D0	UM 07ED0	UM 0A6D0	UM 146D0
10008	UM 02EE0	UM 056E0	UM 07EE0	UM 0A6E0	UM 146E0
10009	UM 02EF0	UM 056F0	UM 07EF0	UM 0A6F0	UM 146F0
10010	UM 02F00	UM 05700	UM 07F00	UM 0A700	UM 14700
10011	UM 02F10	UM 05710	UM 07F10	UM 0A710	UM 14710
10012	UM 02F20	UM 05720	UM 07F20	UM 0A720	UM 14720
10013	UM 02F30	UM 05730	UM 07F30	UM 0A730	UM 14730
10014	UM 02F40	UM 05740	UM 07F40	UM 0A740	UM 14740
10015	UM 02F50	UM 05750	UM 07F50	UM 0A750	UM 14750
10016	UM 02F60	UM 05760	UM 07F60	UM 0A760	UM 14760
10017	UM 02F70	UM 05770	UM 07F70	UM 0A770	UM 14770
10018	UM 02F80	UM 05780	UM 07F80	UM 0A780	UM 14780
10019	UM 02F90	UM 05790	UM 07F90	UM 0A790	UM 14790
10020	UM 02FA0	UM 057A0	UM 07FA0	UM 0A7A0	UM 147A0
10021	UM 02FB0	UM 057B0	UM 07FB0	UM 0A7B0	UM 147B0
10022	UM 02FC0	UM 057C0	UM 07FC0	UM 0A7C0	UM 147C0
10023	UM 02FD0	UM 057D0	UM 07FD0	UM 0A7D0	UM 147D0
10024	UM 02FE0	UM 057E0	UM 07FE0	UM 0A7E0	UM 147E0
10025	UM 02FF0	UM 057F0	UM 07FF0	UM 0A7F0	UM 147F0



◆ KEY POINTS

- There are two areas in the expansion area of positioning table. It is recommended to select an area with consecutive UM numbers according to the number of used tables.

Number of necessary tables	Area and table numbers to be used
1 to 25	Expansion area 1: Table numbers 10001 to 10025
26 to 75	Expansion area 2: Table numbers 10026 to 10100
76 to 100	Both the expansion areas 1 and 2 are used.

- For details of the expansion area, refer to "14.1.4 Types of Positioning Data Setting Areas".

Specifications

■ First address of each positioning table (Expansion area 2: 10026 to 100100)

Table no.	1st axis	2nd axis	3rd axis	4th axis	Virtual axis
10026	UM 0A850	UM 0AD00	UM 0B1B0	UM 0B660	UM 0C920
10027	UM 0A860	UM 0AD10	UM 0B1C0	UM 0B670	UM 0C930
10028	UM 0A870	UM 0AD20	UM 0B1D0	UM 0B680	UM 0C940
10029	UM 0A880	UM 0AD30	UM 0B1E0	UM 0B690	UM 0C950
10030	UM 0A890	UM 0AD40	UM 0B1F0	UM 0B6A0	UM 0C960
10031	UM 0A8A0	UM 0AD50	UM 0B200	UM 0B6B0	UM 0C970
10032	UM 0A8B0	UM 0AD60	UM 0B210	UM 0B6C0	UM 0C980
10033	UM 0A8C0	UM 0AD70	UM 0B220	UM 0B6D0	UM 0C990
10034	UM 0A8D0	UM 0AD80	UM 0B230	UM 0B6E0	UM 0C9A0
10035	UM 0A8E0	UM 0AD90	UM 0B240	UM 0B6F0	UM 0C9B0
10036	UM 0A8F0	UM 0ADA0	UM 0B250	UM 0B700	UM 0C9C0
10037	UM 0A900	UM 0ADB0	UM 0B260	UM 0B710	UM 0C9D0
10038	UM 0A910	UM 0ADC0	UM 0B270	UM 0B720	UM 0C9E0
10039	UM 0A920	UM 0ADD0	UM 0B280	UM 0B730	UM 0C9F0
10040	UM 0A930	UM 0ADE0	UM 0B290	UM 0B740	UM 0CA00
10041	UM 0A940	UM 0ADF0	UM 0B2A0	UM 0B750	UM 0CA10
10042	UM 0A950	UM 0AE00	UM 0B2B0	UM 0B760	UM 0CA20
10043	UM 0A960	UM 0AE10	UM 0B2C0	UM 0B770	UM 0CA30
10044	UM 0A970	UM 0AE20	UM 0B2D0	UM 0B780	UM 0CA40
10045	UM 0A980	UM 0AE30	UM 0B2E0	UM 0B790	UM 0CA50
10046	UM 0A990	UM 0AE40	UM 0B2F0	UM 0B7A0	UM 0CA60
10047	UM 0A9A0	UM 0AE50	UM 0B300	UM 0B7B0	UM 0CA70
10048	UM 0A9B0	UM 0AE60	UM 0B310	UM 0B7C0	UM 0CA80
10049	UM 0A9C0	UM 0AE70	UM 0B320	UM 0B7D0	UM 0CA90
10050	UM 0A9D0	UM 0AE80	UM 0B330	UM 0B7E0	UM 0CAA0
10051	UM 0A9E0	UM 0AE90	UM 0B340	UM 0B7F0	UM 0CAB0
10052	UM 0A9F0	UM 0AEA0	UM 0B350	UM 0B800	UM 0CAC0
10053	UM 0AA00	UM 0AEB0	UM 0B360	UM 0B810	UM 0CAD0
10054	UM 0AA10	UM 0AEC0	UM 0B370	UM 0B820	UM 0CAE0
10055	UM 0AA20	UM 0AED0	UM 0B380	UM 0B830	UM 0CAF0
10056	UM 0AA30	UM 0AEE0	UM 0B390	UM 0B840	UM 0CB00
10057	UM 0AA40	UM 0AEF0	UM 0B3A0	UM 0B850	UM 0CB10
10058	UM 0AA50	UM 0AF00	UM 0B3B0	UM 0B860	UM 0CB20
10059	UM 0AA60	UM 0AF10	UM 0B3C0	UM 0B870	UM 0CB30
10060	UM 0AA70	UM 0AF20	UM 0B3D0	UM 0B880	UM 0CB40

17.6 Details of Each Axis Setting Area in Unit Memory

Table no.	1st axis	2nd axis	3rd axis	4th axis	Virtual axis
10061	UM 0AA80	UM 0AF30	UM 0B3E0	UM 0B890	UM 0CB50
10062	UM 0AA90	UM 0AF40	UM 0B3F0	UM 0B8A0	UM 0CB60
10063	UM 0AAA0	UM 0AF50	UM 0B400	UM 0B8B0	UM 0CB70
10064	UM 0AAB0	UM 0AF60	UM 0B410	UM 0B8C0	UM 0CB80
10065	UM 0AAC0	UM 0AF70	UM 0B420	UM 0B8D0	UM 0CB90
10066	UM 0AAD0	UM 0AF80	UM 0B430	UM 0B8E0	UM 0CBA0
10067	UM 0AAE0	UM 0AF90	UM 0B440	UM 0B8F0	UM 0CBB0
10068	UM 0AAF0	UM 0AFA0	UM 0B450	UM 0B900	UM 0CBC0
10069	UM 0AB00	UM 0AFB0	UM 0B460	UM 0B910	UM 0CBD0
10070	UM 0AB10	UM 0AFC0	UM 0B470	UM 0B920	UM 0CBE0
10071	UM 0AB20	UM 0AFD0	UM 0B480	UM 0B930	UM 0CBF0
10072	UM 0AB30	UM 0AFE0	UM 0B490	UM 0B940	UM 0CC00
10073	UM 0AB40	UM 0AFF0	UM 0B4A0	UM 0B950	UM 0CC10
10074	UM 0AB50	UM 0B000	UM 0B4B0	UM 0B960	UM 0CC20
10075	UM 0AB60	UM 0B010	UM 0B4C0	UM 0B970	UM 0CC30
10076	UM 0AB70	UM 0B020	UM 0B4D0	UM 0B980	UM 0CC40
10077	UM 0AB80	UM 0B030	UM 0B4E0	UM 0B990	UM 0CC50
10078	UM 0AB90	UM 0B040	UM 0B4F0	UM 0B9A0	UM 0CC60
10079	UM 0ABA0	UM 0B050	UM 0B500	UM 0B9B0	UM 0CC70
10080	UM 0ABB0	UM 0B060	UM 0B510	UM 0B9C0	UM 0CC80
10081	UM 0ABC0	UM 0B070	UM 0B520	UM 0B9D0	UM 0CC90
10082	UM 0ABD0	UM 0B080	UM 0B530	UM 0B9E0	UM 0CCA0
10083	UM 0ABE0	UM 0B090	UM 0B540	UM 0B9F0	UM 0CCB0
10084	UM 0ABF0	UM 0B0A0	UM 0B550	UM 0BA00	UM 0CCC0
10085	UM 0AC00	UM 0B0B0	UM 0B560	UM 0BA10	UM 0CCD0
10086	UM 0AC10	UM 0B0C0	UM 0B570	UM 0BA20	UM 0CCE0
10087	UM 0AC20	UM 0B0D0	UM 0B580	UM 0BA30	UM 0CCF0
10088	UM 0AC30	UM 0B0E0	UM 0B590	UM 0BA40	UM 0CD00
10089	UM 0AC40	UM 0B0F0	UM 0B5A0	UM 0BA50	UM 0CD10
10090	UM 0AC50	UM 0B100	UM 0B5B0	UM 0BA60	UM 0CD20
10091	UM 0AC60	UM 0B110	UM 0B5C0	UM 0BA70	UM 0CD30
10092	UM 0AC70	UM 0B120	UM 0B5D0	UM 0BA80	UM 0CD40
10093	UM 0AC80	UM 0B130	UM 0B5E0	UM 0BA90	UM 0CD50
10094	UM 0AC90	UM 0B140	UM 0B5F0	UM 0BAA0	UM 0CD60
10095	UM 0ACA0	UM 0B150	UM 0B600	UM 0BAB0	UM 0CD70
10096	UM 0ACB0	UM 0B160	UM 0B610	UM 0BAC0	UM 0CD80
10097	UM 0ACC0	UM 0B170	UM 0B620	UM 0BAD0	UM 0CD90
10098	UM 0ACD0	UM 0B180	UM 0B630	UM 0BAE0	UM 0CDA0
10099	UM 0ACE0	UM 0B190	UM 0B640	UM 0BAF0	UM 0CDB0
10100	UM 0ACF0	UM 0B1A0	UM 0B650	UM 0BB00	UM 0CDC0

17.7 Unit Memory Synchronous Control Setting Area

17.7.1 Synchronous Control Setting Area

This is the area for setting the synchronous control. When making the setting using the configuration menu, these values are automatically stored. It is not necessary to set them.

Unit memory no. (Hex)	Description	
UM 16000 - UM1600F	Synchronous setting area of 1st axis	Synchronous control common setting area
UM 16010 - UM1601F		Electronic gear setting area
UM 16020 - UM1604F		Clutch setting area
UM 16050 - UM1606F		Electronic cam setting area
UM 16070 - UM1607F	Synchronous setting area of 2nd axis	Synchronous control common setting area
UM 16080 - UM1608F		Electronic gear setting area
UM 16090 - UM160BF		Clutch setting area
UM 160C0 - UM160DF		Electronic cam setting area
UM 160E0 - UM160EF	Synchronous setting area of 3rd axis	Synchronous control common setting area
UM 160F0 - UM160FF		Electronic gear setting area
UM 16100 - UM1612F		Clutch setting area
UM 16130 - UM1614F		Electronic cam setting area
UM 16150 - UM1615F	Synchronous setting area of 4th axis	Synchronous control common setting area
UM 16160 - UM1616F		Electronic gear setting area
UM 16170 - UM1619F		Clutch setting area
UM 161A0 - UM161BF		Electronic cam setting area
UM 161C0 - UM163FF	Reserved for system	

17.7.2 Detailed Information on Synchronous Control Setting Area

■ Synchronous control common setting area of 1st axis

Unit memory no. (Hex)	Name	Default	Description																								
UM16000	Synchronous master axis selection of 1st axis	H0	<p>Set the master axis for each axis.</p> <table border="1"> <thead> <tr> <th>Set value</th> <th>Master axis</th> <th>Set value</th> <th>Master axis</th> </tr> </thead> <tbody> <tr> <td>H0</td> <td>No synchronous master axis or the setting target axis is the master axis.</td> <td>H10</td> <td>仮想軸</td> </tr> <tr> <td>H1</td> <td>1st axis</td> <td>H21</td> <td>Pulse input 1</td> </tr> <tr> <td>H2</td> <td>2nd axis</td> <td>H22</td> <td>Pulse input 2</td> </tr> <tr> <td>H3</td> <td>3rd axis</td> <td>H23</td> <td>Pulse input 3</td> </tr> <tr> <td>H4</td> <td>4th axis</td> <td>H24</td> <td>Pulse input 4</td> </tr> </tbody> </table>	Set value	Master axis	Set value	Master axis	H0	No synchronous master axis or the setting target axis is the master axis.	H10	仮想軸	H1	1st axis	H21	Pulse input 1	H2	2nd axis	H22	Pulse input 2	H3	3rd axis	H23	Pulse input 3	H4	4th axis	H24	Pulse input 4
Set value	Master axis	Set value	Master axis																								
H0	No synchronous master axis or the setting target axis is the master axis.	H10	仮想軸																								
H1	1st axis	H21	Pulse input 1																								
H2	2nd axis	H22	Pulse input 2																								
H3	3rd axis	H23	Pulse input 3																								
H4	4th axis	H24	Pulse input 4																								
UM16001	Each axis synchronous output function selection of 1st axis	H0	<p>The state of the synchronous operating function set for the axis is stored.</p> <table border="1"> <thead> <tr> <th>bit</th> <th>Functions</th> <th>Setting</th> </tr> </thead> <tbody> <tr> <td>0</td> <td>Electronic gear setting</td> <td rowspan="4">0: No 1: Yes</td> </tr> <tr> <td>1</td> <td>Clutch operation settings</td> </tr> <tr> <td>2</td> <td>Electronic cam operation settings</td> </tr> <tr> <td>3</td> <td>Advance angle correction synchronous setting</td> </tr> <tr> <td>15-4</td> <td>Area reserved for system</td> <td></td> </tr> </tbody> </table>	bit	Functions	Setting	0	Electronic gear setting	0: No 1: Yes	1	Clutch operation settings	2	Electronic cam operation settings	3	Advance angle correction synchronous setting	15-4	Area reserved for system										
bit	Functions	Setting																									
0	Electronic gear setting	0: No 1: Yes																									
1	Clutch operation settings																										
2	Electronic cam operation settings																										
3	Advance angle correction synchronous setting																										
15-4	Area reserved for system																										
UM16002	Synchronous slave single deceleration stop deceleration method of 1st axis	H0	<p>Set the deceleration method when performing the deceleration stop during the synchronous operation.</p> <table border="1"> <thead> <tr> <th>bit</th> <th>Functions</th> <th>Setting</th> </tr> </thead> <tbody> <tr> <td>0</td> <td>Not used</td> <td rowspan="2">0: Linear, 1: S shape</td> </tr> <tr> <td>1</td> <td>Deceleration method</td> </tr> <tr> <td>15-2</td> <td>Area reserved for system</td> <td></td> </tr> </tbody> </table>	bit	Functions	Setting	0	Not used	0: Linear, 1: S shape	1	Deceleration method	15-2	Area reserved for system														
bit	Functions	Setting																									
0	Not used	0: Linear, 1: S shape																									
1	Deceleration method																										
15-2	Area reserved for system																										
UM16003	Synchronous slave single deceleration stop deceleration time of 1st axis	H0	<p>Set the deceleration time when performing the deceleration stop during the synchronous operation. Setting range: 0 to 10,000 (ms) Any other settings will be errors.</p>																								
UM16004 - 16000F	Reserved for system	-	-																								

(Note 1): The advanced angle correction function is available for the unit of Ver. 1.5 or later.

■ Electronic gear setting area of 1st axis

Unit memory no. (Hex)	Name	Default	Description
UM16010 -UM16011	Each axis gear ratio numerator	U1	<p>Set the numerator and denominator for the gear ratio of electronic gear separately. Setting range: U1 to U2,147,483,647</p> <p>Electronic gear ratio is determined by the following formula. Output speed of electronic gear = Operating speed of master axis x (Gear ratio numerator/Gear ratio denominator)</p>
UM16012 -UM16013	Each axis gear ratio denominator	U1	
UM16014	Each axis gear change time	U1	<p>Set the time required to change the current gear ratio to a new gear ratio when the new gear ratio is set for the electronic gear in operation. U1 to U 10000 [ms]</p>
UM16015 -UM16001F	Reserved for system	-	-

Specifications

■ Clutch setting area of 1st axis

Unit memory no. (Hex)	Name	Default	Description
UM16020	Clutch ON trigger types	H0	H0: I/O clutch ON request
UM16021	Clutch ON edge selection	H0	Set enabled conditions for the trigger signal. H0: Level H1: Rising edge H2: Falling edge
UM16022 -UM16027	Reserved for system	—	—
UM16028	Clutch OFF trigger types	H0	H0: I/O clutch OFF request H11: I/O + Phase after clutch control clutch OFF
UM16029	Clutch OFF edge selection	H0	Set enabled conditions for the trigger signal. H0: Invalid H1: Rising edge H2: Falling edge
UM1602A	Clutch OFF phase ratio	U0	Set the ratio for the phase at which the clutch turns OFF when selecting "I/O + Phase after clutch control" for the clutch off trigger type. Setting range: 0 to 99 (%)
UM1602B -UM1602F	Reserved for system	—	—
UM16030	Clutch ON method	H0	H0: Direct H1: Slip
UM16031			
UM16032	Clutch ON slip method	H0	H0: Slip time setting
UM16033	Clutch ON slip time	U1	1 to 10000 ms
UM16034 -UM16035	Reserved for system	—	—
UM16036	Clutch ON slip curve selection	H0	H0: Linear
UM16037 -UM1603F	Reserved for system	—	—
UM16040	Clutch OFF method	H0	H0: Direct H1: Slip
UM16041	Reserved for system	—	—
UM16042	Clutch OFF slip method	H0	H0: Slip time setting
UM16043	Clutch OFF slip time	U1	1 to 10000 ms
UM16044 -UM16045	Reserved for system	—	—
UM16046	Clutch OFF slip curve selection	H0	H0: Linear
UM16047 -UM1604F	Reserved for system	—	—

17.7 Unit Memory Synchronous Control Setting Area

■ Electronic cam setting area of 1st axis

Unit memory no. (Hex)	Name	Default	Description
UM16050 - UM16051	Cam control synchronous master axis cycle	U1	Set the cam control synchronous master cycle. U1 to U2147483647
UM16052	Reserved for system	–	–
UM16053	Used cam pattern number	U1	Set the registered cam pattern number to be used. 1 to (16)
UM16054 - UM16055	Cam stroke amount	U1	Displacement amount upper limit setting for cam control U1 to U2147483647
UM16056 - UM16057	Advance angle correction reference amount	K0	Set the correction reference amount for calculating the advance angle correction amount when using the advance angle correction function. Setting range: K-1,073,741,823 to K1,073,741,823 The unit follows the unit system of the master axis. pulse: -1,073,741,823 to +1,073,741,823 pulse μm (0.1 μm): -107,374,182.3 to +107,374,182.3 μm μm (1 μm): -1,073,741,823 to +1,073,741,823 μm inch (0.00001 inch): -10,737.41823 to +10,737.41823 inch inch (0.0001 inch): -107,374.1823 to +107,374.1823 inch degree (0.1 degree): -107,374,182.3 to +107,374,182.3 degree degree (1 degree): -1,073,741,823 to +1,073,741,823 degree
UM16058 - UM16059	Advance angle correction speed	U100	Set the reference speed for calculating the advance angle correction amount when using the advance angle correction function. Setting range: U1 to U32,767,000 (Specified unit system) The unit follows the unit system of the master axis. pulse: 1 to 32,767,000 pps μm : 1 to 32,767,000 $\mu\text{m}/\text{s}$ inch: 0.001 to 32,767.000 inch/s degree: 0.001 to 32,767.000 rev/s
UM1605A	Advance angle correction parameter change time	U100	Set the time required until a changed value is reflected when the parameter related to advance angle correction (advance angle correction reference speed or advance angle correction reference amount) is changed during the electronic cam operation. Setting range: U1 to U10000ms
UM1605B - UM1606F	Reserved for system	–	–

(Note 1): The advanced angle correction function is available for the unit of Ver.1.5 or later.

Specifications

■ Synchronous control common setting area of 2nd axis

Unit memory no. (Hex)	Name	Default	Description
UM16070	Synchronous master axis selection of each axis	H0	Refer to the description for the 1st axis.
UM16071	Synchronous output function selection of each axis	H0	Refer to the description for the 1st axis.
UM16072 -UM1607F	Reserved for system	–	–

(Note 1): The advanced angle correction function is available for the unit of Ver.1.5 or later.

■ Electronic gear setting area of 2nd axis

Unit memory no. (Hex)	Name	Default	Description
UM16080 -UM16081	Gear ratio numerator of each axis	U1	Refer to the description for the 1st axis.
UM16082 -UM16083	Gear ratio denominator of each axis	U1	Refer to the description for the 1st axis.
UM16084	Gear ratio change time of each axis	U1	Refer to the description for the 1st axis.
UM16085 -UM1608F	Reserved for system	–	–

■ Clutch setting area of 2nd axis

Unit memory no. (Hex)	Name	Default	Description
UM16090	Clutch ON trigger type	H0	Refer to the description for the 1st axis.
UM16091	Clutch ON edge selection	H0	Refer to the description for the 1st axis.
UM16092 -UM16097	Reserved for system	–	–
UM16098	Clutch OFF trigger type	H0	Refer to the description for the 1st axis.
UM16099	Clutch OFF edge selection	H0	Refer to the description for the 1st axis.
UM1609A	Clutch OFF phase ratio	U0	Refer to the description for the 1st axis.
UM1609B -UM1609F	Reserved for system	–	Refer to the description for the 1st axis.
UM160A0	Clutch ON method	H0	Refer to the description for the 1st axis.
UM160A1	Reserved for system	–	–
UM160A2	Clutch ON slip method	H0	Refer to the description for the 1st axis.
UM160A3	Clutch ON slip time	U1	Refer to the description for the 1st axis.
UM160A4 -UM160A5	Reserved for system	–	–
UM160A6	Clutch ON slip curve selection	H0	Refer to the description for the 1st axis.

17.7 Unit Memory Synchronous Control Setting Area

Unit memory no. (Hex)	Name	Default	Description
UM160A7 -UM160AF	Reserved for system	-	-
UM160B0	Clutch OFF method	H0	Refer to the description for the 1st axis.
UM160B1	Reserved for system	-	-
UM160B2	Clutch OFF slip method	H0	Refer to the description for the 1st axis.
UM160B3	Clutch OFF slip time	U1	Refer to the description for the 1st axis.
UM160B4 -UM160B5	Reserved for system	-	-
UM160B6	Clutch OFF slip curve selection	H0	Refer to the description for the 1st axis.
UM160B7 -UM160BF	Reserved for system	-	-

■ Electronic cam setting area of 2nd axis

Unit memory no. (Hex)	Name	Default	Description
UM160C0 -UM160C1	Cam control synchronous master axis cycle	U1	Refer to the description for the 1st axis.
UM160C2	Reserved for system	-	-
UM160C3	Used cam pattern number	U1	Refer to the description for the 1st axis.
UM160C4 -UM160C5	Cam stroke amount	U1	Refer to the description for the 1st axis.
UM160C6 -UM160C7	Advance angle correction reference amount	K0	Refer to the description for the 1st axis.
UM160C8 -UM160C9	Advance angle correction speed	U100	Refer to the description for the 1st axis.
UM160CA	Advance angle correction parameter change time	U100	Refer to the description for the 1st axis.
UM160CB -UM160DF	Reserved for system	-	-

(Note 1):The advanced angle correction function is available for the unit of Ver.1.5 or later.

Specifications

■ Synchronous control common setting area of 3rd axis

Unit memory no. (Hex)	Name	Default	Description
UM160E0	Synchronous master axis selection of each axis	H0	Refer to the description for the 1st axis.
UM160E1	Synchronous output function selection of each axis	H0	Refer to the description for the 1st axis.
UM160E2 -UM160EF	Reserved for system	–	–

(Note 1): The advanced angle correction function is available for the unit of Ver.1.5 or later.

■ Electronic gear setting area of 3rd axis

Unit memory no. (Hex)	Name	Default	Description
UM160F0 -UM160F1	Gear ratio numerator of each axis	U1	Refer to the description for the 1st axis.
UM160F2 -UM160F3	Gear ratio denominator of each axis	U1	Refer to the description for the 1st axis.
UM160F4	Gear ratio change time of each axis	U1	Refer to the description for the 1st axis.
UM161F5 -UM161FF	Reserved for system	–	–

■ Clutch setting area of 3rd axis

Unit memory no. (Hex)	Name	Default	Description
UM16100	Clutch ON trigger type	H0	Refer to the description for the 1st axis.
UM16101	Clutch ON edge selection	H0	Refer to the description for the 1st axis.
UM16102 -UM16107	Reserved for system	–	–
UM16108	Clutch OFF trigger type	H0	Refer to the description for the 1st axis.
UM16109	Clutch OFF edge selection	H0	Refer to the description for the 1st axis.
UM1610A	Clutch OFF phase ratio	U0	Refer to the description for the 1st axis.
UM1610B -UM1610F	Reserved for system	–	–
UM16110	Clutch ON method	H0	Refer to the description for the 1st axis.
UM16111	Reserved for system	–	–
UM16112	Clutch ON slip method	H0	Refer to the description for the 1st axis.
UM16113	Clutch ON slip time	U1	Refer to the description for the 1st axis.
UM16114 -UM16115	Reserved for system	–	–
UM16116	Clutch ON slip curve selection	H0	Refer to the description for the 1st axis.

17.7 Unit Memory Synchronous Control Setting Area

Unit memory no. (Hex)	Name	Default	Description
UM16117 -UM16119	Reserved for system	-	-
UM16110	Clutch OFF method	H0	Refer to the description for the 1st axis.
UM16111	Reserved for system	-	-
UM16112	Clutch OFF slip method	H0	Refer to the description for the 1st axis.
UM16113	Clutch OFF slip time	U1	Refer to the description for the 1st axis.
UM16114 -UM16115	Reserved for system	-	-
UM16116	Clutch OFF slip curve selection	H0	Refer to the description for the 1st axis.
UM16117 -UM1611F	Reserved for system	-	-

■ Electronic cam setting area of 3rd axis

Unit memory no. (Hex)	Name	Default	Description
UM16130 -UM16131	Cam control synchronous master axis cycle	U1	Refer to the description for the 1st axis.
UM16132	Reserved for system	-	-
UM16133	Used cam pattern number	U1	Refer to the description for the 1st axis.
UM16134 -UM16135	Cam stroke amount	U1	Refer to the description for the 1st axis.
UM16136 -UM16137	Advance angle correction reference amount	K0	Refer to the description for the 1st axis.
UM16138 -UM16139	Advance angle correction speed	U100	Refer to the description for the 1st axis.
UM1613A	Advance angle correction parameter change time	U100	Refer to the description for the 1st axis.
UM1613B -UM1614F	Reserved for system	-	-

(Note 1): The advanced angle correction function is available for the unit of Ver.1.5 or later.

Specifications

■ Synchronous control common setting area of 4th axis

Unit memory no. (Hex)	Name	Default	Description
UM16150	Synchronous master axis selection of each axis	H0	Refer to the description for the 1st axis.
UM16151	Synchronous output function selection of each axis	H0	Refer to the description for the 1st axis.
UM16152 -UM1615F	Reserved for system	–	–

(Note 1): The advanced angle correction function is available for the unit of Ver.1.5 or later.

■ Electronic gear setting area of 4th axis

Unit memory no. (Hex)	Name	Default	Description
UM16160 -UM16161	Gear ratio numerator of each axis	U1	Refer to the description for the 1st axis.
UM16162 -UM16163	Gear ratio denominator of each axis	U1	Refer to the description for the 1st axis.
UM16164	Gear ratio change time of each axis	U1	Refer to the description for the 1st axis.
UM16165 -UM1616F	Reserved for system	–	–

■ Clutch setting area of 4th axis

Unit memory no. (Hex)	Name	Default	Description
UM16170	Clutch ON trigger type	H0	Refer to the description for the 1st axis.
UM16171	Clutch ON edge selection	H0	Refer to the description for the 1st axis.
UM16172 -UM16177	Reserved for system	–	–
UM16178	Clutch OFF trigger type	H0	Refer to the description for the 1st axis.
UM16179	Clutch OFF edge selection	H0	Refer to the description for the 1st axis.
UM1617A	Clutch OFF phase ratio	U0	Refer to the description for the 1st axis.
UM1617B -UM1617F	Reserved for system	–	–
UM16180	Clutch ON method	H0	Refer to the description for the 1st axis.
UM16181	Reserved for system	–	–
UM16182	Clutch ON slip method	H0	Refer to the description for the 1st axis.
UM16183	Clutch ON slip time	U1	Refer to the description for the 1st axis.
UM16184 -UM16185	Reserved for system	–	–
UM16186	Clutch ON slip curve selection	H0	Refer to the description for the 1st axis.

17.7 Unit Memory Synchronous Control Setting Area

Unit memory no. (Hex)	Name	Default	Description
UM16187 -UM16189	Reserved for system	-	-
UM16190	Clutch OFF method	H0	Refer to the description for the 1st axis.
UM16191	Reserved for system	-	-
UM16192	Clutch OFF slip method	H0	Refer to the description for the 1st axis.
UM16193	Clutch OFF slip time	U1	Refer to the description for the 1st axis.
UM16194 -UM16195	Reserved for system	-	-
UM16196	Clutch OFF slip curve selection	H0	Refer to the description for the 1st axis.
UM16197 -UM1619F	Reserved for system	-	-

■ Electronic cam setting area of 4th axis

Unit memory no. (Hex)	Name	Default	Description
UM161A0 -UM161A1	Cam control synchronous master axis cycle	U1	Refer to the description for the 1st axis.
UM161A2	Reserved for system	-	-
UM161A3	Used cam pattern number	U1	Refer to the description for the 1st axis.
UM161A4 -UM161A5	Cam stroke amount	U1	Refer to the description for the 1st axis.
UM161A6 -UM161A7	Advance angle correction reference amount	K0	Refer to the description for the 1st axis.
UM161A8 -UM161A9	Advance angle correction speed	U100	Refer to the description for the 1st axis.
UM161AA	Advance angle correction parameter change time	U100	Refer to the description for the 1st axis.
UM161AB -UM161BF	Reserved for system	-	-

(Note 1): The advanced angle correction function is available for the unit of Ver.1.5 or later.

17.8 Positioning Operation Change Setting Area

17.8.1 Positioning Speed/Movement Amount Change Parameter

■ 1st axis

Unit memory No. (Hex)	Name	Default	Description
UM 17C00	Positioning speed change of 1st axis Ratio specification (Override)	U100	Area for setting the change rate (%) to the ratio specification (override) command speed of the positioning speed change. The speed change request by I/O is not necessary, and the change becomes valid when the set value (ratio) is set. U1 to U300 (%)
UM 17C01	Positioning speed change of 1st axis Change mode selection	H0	Area for setting the range of the positioning speed change. H0: Active table only H1: Active table to E point (until the completion of the operation) In the case of other values, the unit operates as the setting of H0 (Active table only).
UM17C02 -UM17C03	Positioning speed change of 1st axis Change speed	U100	Area for setting a change speed for changing the positioning speed. [Speed specification method: Speed direct specification] U1 to U32,767,000 (Specified unit system)
UM17C04 -UM17C09	Reserved for system	–	–
UM17C0A -UM17C0B	Positioning movement amount change of 1st axis Change movement amount	K0	Area for setting a change movement amount for changing the positioning movement amount. K-1,073,741,823 to K1,073,741,823 (Specified unit system)
UM 17C0C -UM 17C0F	Reserved for system	–	–

(Note): The positioning operation change setting area is available for the unit of Ver.1.3 or later.

17.8 Positioning Operation Change Setting Area

■ 2nd axis

Unit memory No. (Hex)	Name	Description
UM 17C10	Positioning speed change of 2nd axis Ratio specification (Override)	Refer to the descriptions of axis 1.
UM 17C11	Positioning speed change of 2nd axis Change mode selection	Refer to the descriptions of axis 1.
UM 17C12 -UM 17C13	Positioning speed change of 2nd axis Change speed	Refer to the descriptions of axis 1.
Reserved for system	Reserved for system	-
UM 17C1A -UM17C1B	Positioning movement amount change of 2nd axis Change movement amount	Refer to the descriptions of axis 1.
UM 17C1C -UM 17C1F	Reserved for system	-

(Note): The positioning operation change setting area is available for the unit of Ver.1.3 or later.

■ 3rd axis

Unit memory No. (Hex)	Name	Description
UM 17C20	Positioning speed change of 3rd axis Ratio specification (Override)	Refer to the descriptions of axis 1.
UM 17C21	Positioning speed change of 3rd axis Change mode selection	Refer to the descriptions of axis 1.
UM 17C22 -UM 17C23	Positioning speed change of 3rd axis Change speed	Refer to the descriptions of axis 1.
UM 17C24 -UM 17C29	Reserved for system	-
UM 17C2A -UM17C2B	Positioning movement amount change of 3rd axis Change movement amount	Refer to the descriptions of axis 1.
UM 17C2C -UM 17C2F	Reserved for system	-

(Note): The positioning operation change setting area is available for the unit of Ver.1.3 or later.

Specifications

■ 4th axis

Unit memory No. (Hex)	Name	Description
UM 17C30	Positioning speed change of 4th axis Ratio specification (Override)	Refer to the descriptions of axis 1.
UM 17C31	Positioning speed change of 4th axis Change mode selection	Refer to the descriptions of axis 1.
UM 17C32 -UM 17C33	Positioning speed change of 4th axis Change speed	Refer to the descriptions of axis 1.
UM 17C34 -UM 17C39	Reserved for system	–
UM 17C3A -UM17C3B	Positioning movement amount change of 4th axis Change movement amount	Refer to the descriptions of axis 1.
UM 17C3C -UM 17C3F	Reserved for system	–

(Note): The positioning operation change setting area is available for the unit of Ver.1.3 or later.

■ Virtual axis

Unit memory No. (Hex)	Name	Description
UM 17C70	Positioning speed change of virtual axis Ratio specification (Override)	Refer to the descriptions of axis 1.
UM 17C71	Positioning speed change of virtual axis Change mode selection	Refer to the descriptions of axis 1.
UM 17C72 -UM 17C73	Positioning speed change of virtual axis Change speed	Refer to the descriptions of axis 1.
UM 17C74 -UM 17C79	Reserved for system	–
UM 17C7A -UM17C7B	Positioning movement amount change of virtual axis Change movement amount	Refer to the descriptions of axis 1.
UM 17C7C -UM 17C7F	Reserved for system	–

(Note): The positioning operation change setting area is available for the unit of Ver.1.3 or later.

17.9 Cam Pattern Editing Area

17.9.1 Cam Pattern Setting Area

Unit memory No. (Hex)	Name	Default	Description								
UM18000	Cam pattern No.	U0	<p>When reading: Set a cam pattern number to be read out. When rewriting: Set a cam pattern number to be rewritten. The setting range varies depending on resolutions.</p> <table border="1"> <thead> <tr> <th>Pattern resolution</th> <th>Settable range</th> </tr> </thead> <tbody> <tr> <td>1024, 2048, 4096, 8192</td> <td>U1 to U16</td> </tr> <tr> <td>16384</td> <td>U1 to U8</td> </tr> <tr> <td>32768</td> <td>U1 to U4</td> </tr> </tbody> </table>	Pattern resolution	Settable range	1024, 2048, 4096, 8192	U1 to U16	16384	U1 to U8	32768	U1 to U4
Pattern resolution	Settable range										
1024, 2048, 4096, 8192	U1 to U16										
16384	U1 to U8										
32768	U1 to U4										
UM18001	Reserved for system	-	-								
UM18002	No. of cam pattern setting sections	U0	<p>When reading, stores the number of setting sections of the read cam pattern table. When rewriting, sets the number of setting sections of the rewritten cam pattern table. Setting range: U1 to U20</p>								
UM18003	Shift amount	U0	<p>When reading, stores the shift amount of the read cam pattern table. When rewriting, sets the shift amount of the rewritten cam pattern table. Setting range: U0 to U10000 x (0.01%)</p>								
UM18004	Start phase of section 1	U0	<ul style="list-style-type: none"> When reading, stores the start phase in the section 1 of the read cam pattern table. The read value is always 0. When rewriting, sets the start phase in the section 1 of the rewritten cam pattern table. When any value other than 0 is set in the section 1, it cannot be rewritten correctly. <p>Setting range: (Decimal) U0 to U10000 (x 0.01%)</p> <p>When reading, stores it truncating the numbers beyond the third decimal point. When writing, registers it after calculating the numbers beyond the third decimal point by the unit.</p>								
UM18005	Displacement of section 1	K0	<ul style="list-style-type: none"> When reading, stores the displacement in the section 1 of the read cam pattern table. When rewriting, sets the displacement in the section 1 of the rewritten cam pattern table. <p>Setting range: (Decimal): K-10000 to K10000 (x 0.01%)</p> <p>When reading, stores it truncating the numbers beyond the third decimal point. When rewriting, stores it filling the numbers beyond the third decimal point with 0.</p>								

(Note): The cam pattern editing area is available for the unit of Ver.1.5 or later.

Specifications

Unit memory No. (Hex)	Name	Default	Description																																												
UM18006	Cam curve of section 1	U0	<p>When reading, stores the cam curve number of the read cam pattern table. When rewriting, sets the cam curve number of the rewritten cam pattern table.</p> <table border="1"> <thead> <tr> <th>Setting value</th> <th>Cam curve name</th> <th>Setting value</th> <th>Cam curve name</th> </tr> </thead> <tbody> <tr> <td>U10</td> <td>Constant speed</td> <td>U43</td> <td>One-dwell cycloid m=1</td> </tr> <tr> <td>U11</td> <td>Constant acceleration</td> <td>U44</td> <td>One-dwell cycloid m=2/3</td> </tr> <tr> <td>U12</td> <td>Simple harmonic motion</td> <td>U45</td> <td>One-dwell modified trapezoid m=1</td> </tr> <tr> <td>U22</td> <td>Cycloid</td> <td>U46</td> <td>One-dwell modified trapezoid (Ferguson)</td> </tr> <tr> <td>U25</td> <td>Modified trapezoid</td> <td>U47</td> <td>One-dwell modified trapezoid m=2/3</td> </tr> <tr> <td>U26</td> <td>Modified sine</td> <td>U48</td> <td>One-dwell modified sine</td> </tr> <tr> <td>U27</td> <td>Modified uniform velocity</td> <td>U49</td> <td>One-dwell trapezoid</td> </tr> <tr> <td>U33</td> <td>Asymmetric cycloid</td> <td>U51</td> <td>No-dwell modified trapezoid</td> </tr> <tr> <td>U34</td> <td>Asymmetric modified trapezoid</td> <td>U52</td> <td>No-dwell modified uniform velocity</td> </tr> <tr> <td>U35</td> <td>Trapezoid</td> <td>U92</td> <td>NC2 curve</td> </tr> </tbody> </table>	Setting value	Cam curve name	Setting value	Cam curve name	U10	Constant speed	U43	One-dwell cycloid m=1	U11	Constant acceleration	U44	One-dwell cycloid m=2/3	U12	Simple harmonic motion	U45	One-dwell modified trapezoid m=1	U22	Cycloid	U46	One-dwell modified trapezoid (Ferguson)	U25	Modified trapezoid	U47	One-dwell modified trapezoid m=2/3	U26	Modified sine	U48	One-dwell modified sine	U27	Modified uniform velocity	U49	One-dwell trapezoid	U33	Asymmetric cycloid	U51	No-dwell modified trapezoid	U34	Asymmetric modified trapezoid	U52	No-dwell modified uniform velocity	U35	Trapezoid	U92	NC2 curve
Setting value	Cam curve name	Setting value	Cam curve name																																												
U10	Constant speed	U43	One-dwell cycloid m=1																																												
U11	Constant acceleration	U44	One-dwell cycloid m=2/3																																												
U12	Simple harmonic motion	U45	One-dwell modified trapezoid m=1																																												
U22	Cycloid	U46	One-dwell modified trapezoid (Ferguson)																																												
U25	Modified trapezoid	U47	One-dwell modified trapezoid m=2/3																																												
U26	Modified sine	U48	One-dwell modified sine																																												
U27	Modified uniform velocity	U49	One-dwell trapezoid																																												
U33	Asymmetric cycloid	U51	No-dwell modified trapezoid																																												
U34	Asymmetric modified trapezoid	U52	No-dwell modified uniform velocity																																												
U35	Trapezoid	U92	NC2 curve																																												
UM18007	Reserved for system	–	–																																												
UM18008 -UM1800B	Area for section 2	–	<p>Just like the area for the section 1, one word each is allocated to the start phase, displacement, cam curve and the reserved area for system.</p> <table border="1"> <thead> <tr> <th></th> <th>Start phase in section</th> <th>Displacement in section</th> <th>Cam curve in section</th> <th>Reserved for system</th> </tr> </thead> <tbody> <tr> <td rowspan="5">The end of offset address</td> <td>UMx0</td> <td>UMx1</td> <td>UMx2</td> <td>UMx3</td> </tr> <tr> <td>UMx4</td> <td>UMx5</td> <td>UMx6</td> <td>UMx7</td> </tr> <tr> <td>UMx8</td> <td>UMx9</td> <td>UMxA</td> <td>UMxB</td> </tr> <tr> <td>UMxC</td> <td>UMxD</td> <td>UMxE</td> <td>UMxF</td> </tr> </tbody> </table>		Start phase in section	Displacement in section	Cam curve in section	Reserved for system	The end of offset address	UMx0	UMx1	UMx2	UMx3	UMx4	UMx5	UMx6	UMx7	UMx8	UMx9	UMxA	UMxB	UMxC	UMxD	UMxE	UMxF																						
	Start phase in section	Displacement in section		Cam curve in section	Reserved for system																																										
The end of offset address	UMx0	UMx1		UMx2	UMx3																																										
	UMx4	UMx5		UMx6	UMx7																																										
	UMx8	UMx9		UMxA	UMxB																																										
	UMxC	UMxD		UMxE	UMxF																																										
	UM1800C -UM1800F	Area for section 3		–																																											
UM18010 -UM18013	Area for section 4	–																																													
UM18014 -UM18017	Area for section 5	–																																													
UM18018 -UM1801B	Area for section 6	–																																													
UM1801C -UM1801F	Area for section 7	–																																													
UM18020 -UM18023	Area for section 8	–																																													
UM18024 -UM18027	Area for section 9	–																																													
UM18028 -UM1802B	Area for section 10	–																																													
UM1802C -UM1802F	Area for section 11	–																																													
UM18030 -UM18033	Area for section 12	–																																													
UM18034 -UM18037	Area for section 13	–																																													
UM18038 -UM1803B	Area for section 14	–																																													
UM1803C -UM1803F	Area for section 15	–																																													

Unit memory No. (Hex)	Name	Default	Description																									
UM18040 -UM18043	Area for section 16	–	Just like the area for the section 1, one word each is allocated to the start phase, displacement, cam curve and the reserved area for system. <table border="1" data-bbox="659 384 1245 571"> <thead> <tr> <th></th> <th>Start phase in section</th> <th>Displacement in section</th> <th>Cam curve in section</th> <th>Reserved for system</th> </tr> </thead> <tbody> <tr> <td></td> <td>UMx0</td> <td>UMx1</td> <td>UMx2</td> <td>UMx3</td> </tr> <tr> <td>The end of offset address</td> <td>UMx4</td> <td>UMx5</td> <td>UMx6</td> <td>UMx7</td> </tr> <tr> <td></td> <td>UMx8</td> <td>UMx9</td> <td>UMxA</td> <td>UMxB</td> </tr> <tr> <td></td> <td>UMxC</td> <td>UMxD</td> <td>UMxE</td> <td>UMxF</td> </tr> </tbody> </table>		Start phase in section	Displacement in section	Cam curve in section	Reserved for system		UMx0	UMx1	UMx2	UMx3	The end of offset address	UMx4	UMx5	UMx6	UMx7		UMx8	UMx9	UMxA	UMxB		UMxC	UMxD	UMxE	UMxF
	Start phase in section	Displacement in section		Cam curve in section	Reserved for system																							
	UMx0	UMx1		UMx2	UMx3																							
The end of offset address	UMx4	UMx5		UMx6	UMx7																							
	UMx8	UMx9		UMxA	UMxB																							
	UMxC	UMxD	UMxE	UMxF																								
UM18044 -UM18047	Area for section 17	–																										
UM18048 -UM1804B	Area for section 18	–																										
UM1804C -UM1804F	Area for section 19	–																										
UM18050 -UM18053	Area for section 20	–																										
UM18054 -UM18057	Reserved for system	–																										

(Note): The cam pattern editing area is available for the unit of Ver.1.5 or later.

17.9.2 Cam Pattern Editing Execution Confirmation Area

Unit memory No. (Hex)	Name	Default	Description
UM18058	Cam pattern reading result	H0	Stores the result of reading processing (response code). H0: Normal end Other than H0: Abnormal end
UM18059	Cam pattern rewriting result	H0	Stores the result of rewriting processing (response code). H0: Normal end Other than H0: Abnormal end

(Note): In the case of abnormal end, the codes in the following table are stored.

A: Available, -: Not available

Code	Name	Description	Object		Countermeasures
			Read	Write	
H FF01	Cam pattern number setting error	The set value of the cam pattern number is out of the settable range.	A	A	Check the set value of the cam pattern number.
H FF02	Number of cam pattern setting sections setting error	The set number of cam pattern setting sections is out of the settable range.	-	A	Check the set number of setting sections.
H FF03	Shift amount setting error	The set shift amount is out of the settable range.	-	A	Check the set value of the shift amount.
H FF05	Start phase setting error 1	The set start phase is out of the settable range.	-	A	Check the set value of the start phase in each section.
H FF06	Start phase setting error 2	The set start phase is the same as or smaller than the start phase of the previous section.	-	A	Check if the relation between the start phases of each section is (Start phase of section n-1) < (Start phase of section n).
H FF07	Start phase setting error 3	The set start phase of the section 1 is not 0.	-	A	Always set the start phase of the section 1 to 0.
H FF0A	Displacement setting error	The set value of the displacement is out of the settable range.	-	A	Check the set value of the phase in each section.
H FF0B	Cam curve number setting error	The set cam curve number is out of the settable range.	-	A	Check the set value of the cam curve number in each section.
H FF10	Cam pattern reading not executable error 1	An axis in synchronous operation exists.	A	-	Cancel the synchronous operation and execute the reading.
H FF11	Cam pattern reading not executable error 2	An operating axis exists.	A	-	Execute the reading when no operating axis exists.
H FF20	Cam pattern rewriting not executable error 1	An axis in synchronous operation exists.	-	A	Cancel the synchronous operation and execute the rewriting.
H FF21	Cam pattern rewriting not executable error 2	An operating axis exists.	-	A	Execute the rewriting when no operating axis exists.
H FF22	Cam pattern rewriting not executable error 3	The reading request and rewriting request turned on simultaneously.	-	A	Check if the reading request and rewriting request do not turn on simultaneously. When the reading request and rewriting request turn on simultaneously, the reading request takes priority.

Unit memory No. (Hex)	Name	Default	Description				
UM1805A	Cam pattern update flag	HFFFF	<p>Announces the valid cam pattern table data.</p> <p>Bits are allocated to the cam pattern numbers 1 to 15.</p> <p>All the bits of bit0 to bit15 turn to "1" when the mode of the CPU unit changes to the RUN mode and the configuration data set by the tool software becomes valid. When a cam pattern is rewritten by a user program, the bit of a corresponding cam pattern number turns to "0".</p> <p>(*) Do not rewrite this area. If rewritten, the condition cannot be announced properly.</p>				
			bit no.	Name	Default	Description	
			0	Cam pattern No.1 valid condition	1	0: Cam pattern table after rewriting by user program is valid.	
			1	Cam pattern No.2 valid condition	1		
			2	Cam pattern No.3 valid condition	1		
			3	Cam pattern No.4 valid condition	1		
			4	Cam pattern No.5 valid condition	1	1: Configuration data by tool software is valid.	
			5	Cam pattern No.6 valid condition	1		
			6	Cam pattern No.7 valid condition	1		
			7	Cam pattern No.8 valid condition	1		
			8	Cam pattern No.9 valid condition	1		
			9	Cam pattern No.10 valid condition	1		
			10	Cam pattern No.11 valid condition	1		
			11	Cam pattern No.12 valid condition	1		
			12	Cam pattern No.13 valid condition	1		
			13	Cam pattern No.14 valid condition	1		
			14	Cam pattern No.15 valid condition	1		
15	Cam pattern No.16 valid condition	1					

17.10 Dimensions

■ 2-axis type

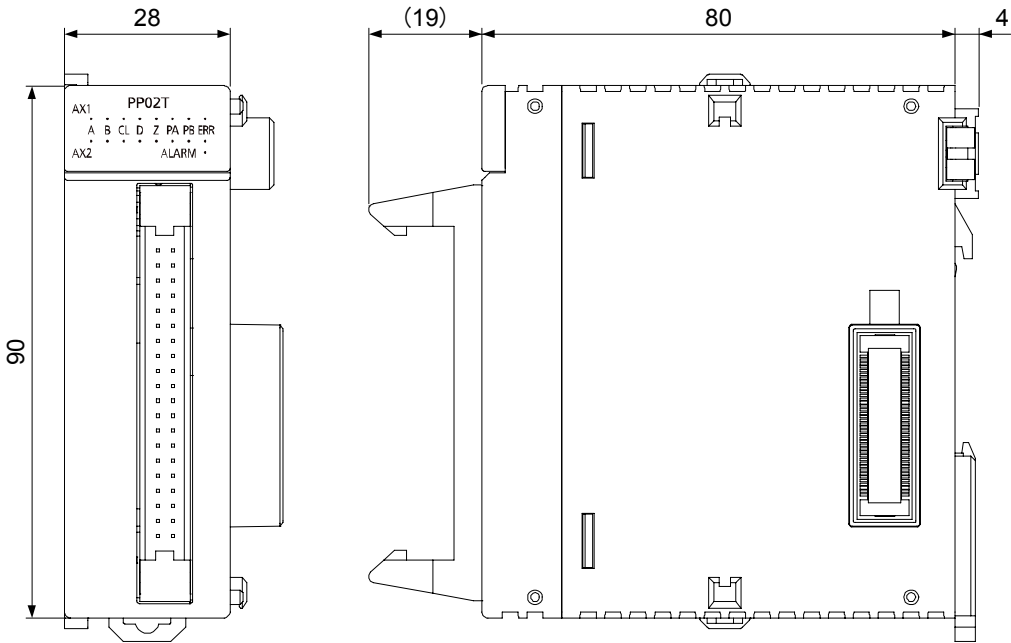

(Unit: mm)

■ 4-axis type

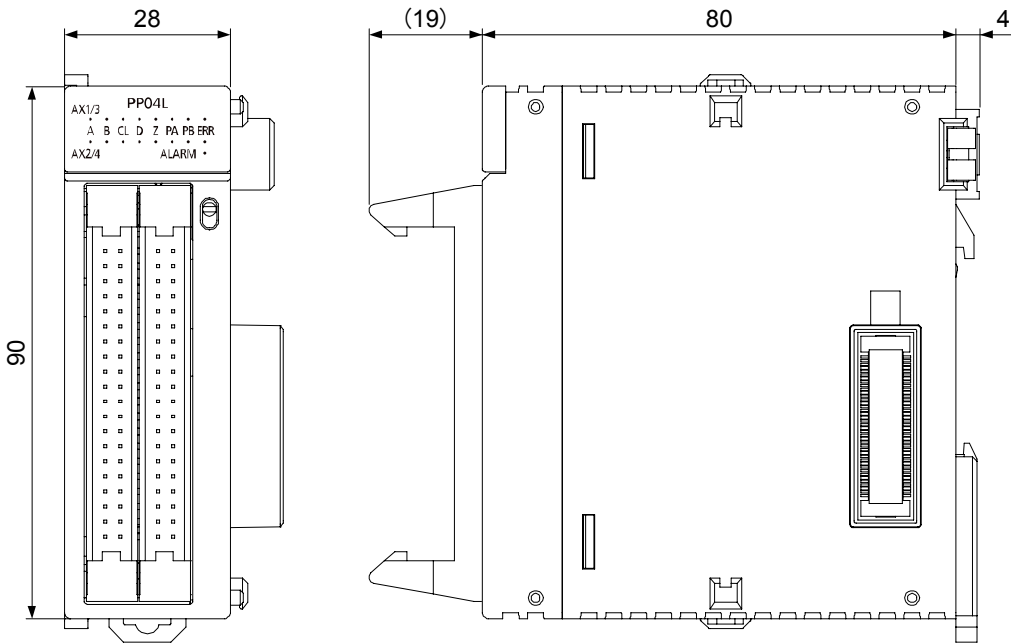

(Unit: mm)

18

Sample program

18.1 Basic Configuration and Contact Allocations of Sample Programs

In the sample programs, the internal relays are used for the start contacts of each operation. Connect them to the input contacts such as switches as needed.

■ Basic Configuration

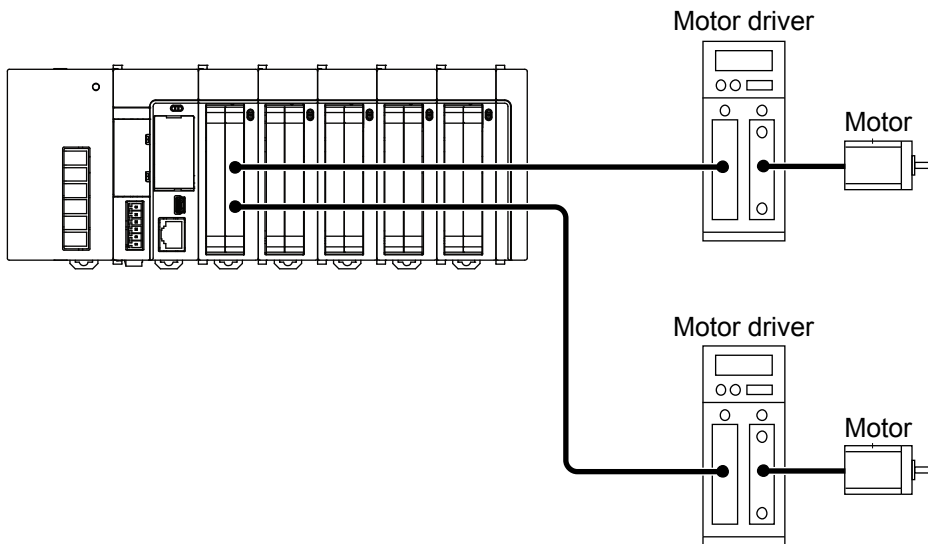

The positioning unit is installed in slot 1. The 1st axis and 2nd axis of the positioning unit connect to a stepping motor each, with the linear interpolation of the 2nd axis sampled. This example is shown on the condition that parameter settings for each axis are made in the positioning setting menu of the programming tool and saved in the positioning unit.

■ Used contacts and data registers

Number	Description
R2	Request home return
R3	Request positioning start
R4	1st axis JOG forward request
R5	1st axis JOG reverse request
R6	2nd axis JOG forward request
R7	2nd axis JOG reverse request
R10	Error clear
R11	Request set value change
R100	Operation enabled flag for 1st axis
R101	1st axis JOG forward OFF edge
R102	1st axis JOG reverse OFF edge
R200	Operation enabled flag for 2nd axis
R201	2nd axis JOG forward OFF edge
R202	2nd axis JOG reverse OFF edge

18.1 Basic Configuration and Contact Allocations of Sample Programs

Number	Description
X100	Ready positioning flag
X104	Tool operation for all axes
X107	Recalculation done flag
X118	1st axis BUSY flag
X119	2nd axis BUSY flag
X160	Error occurrence annunciation for 1st axis
X161	Error occurrence annunciation for 2nd axis
Y107	Request recalculation
Y110	Positioning start for 1st axis
Y118	Home return of 1st axis
Y119	Home return of 2nd axis
Y120	1st axis JOG forward
Y121	1st axis JOG reverse
Y122	2nd axis JOG forward
Y123	2nd axis JOG reverse
Y160	Error clear for 1st axis
Y161	Error clear for 2nd axis

Number	Description
DT0	Starting table number
DT101	Number of errors of 1st axis
DT102 - DT115	Error contents of 1st axis
DT121	Number of errors of 2nd axis
DT122 - DT135	Error contents of 2nd axis
DT10 - DT25	Positioning data (of 1 table) of 1st axis
DT30 - DT45	Positioning data (of 1 table) of 2nd axis

18.2 Sample program

18.2.1 When Settings Done in Standard Area with Programming tool

■ Sample program

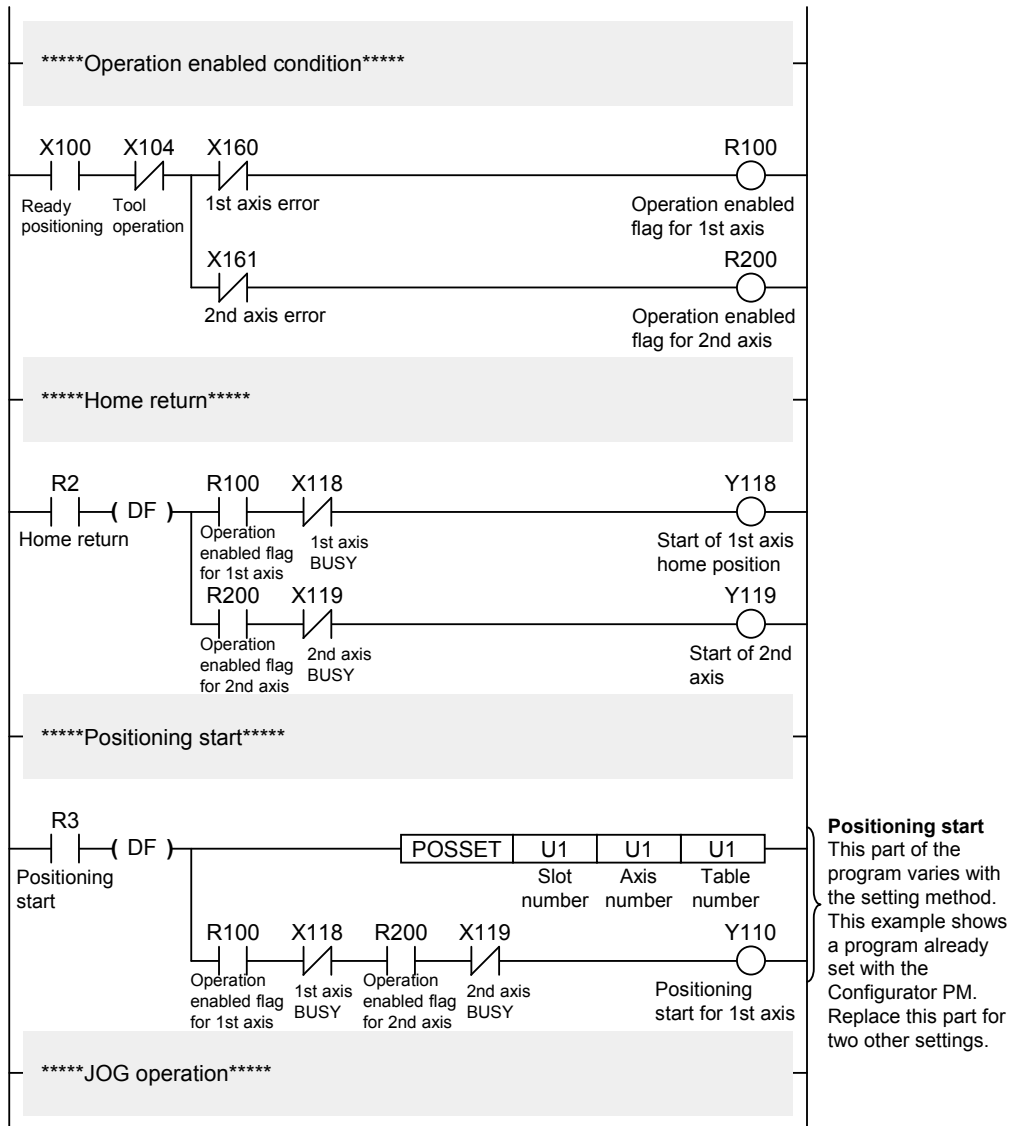

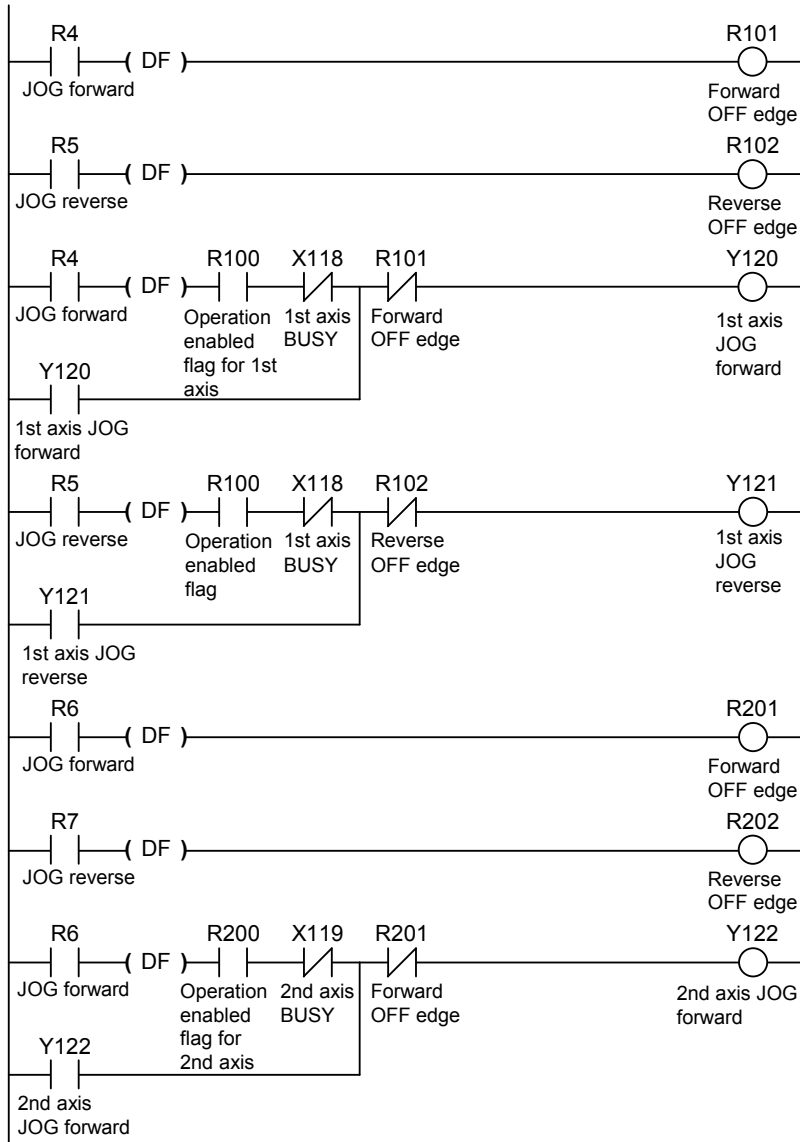

Sample program

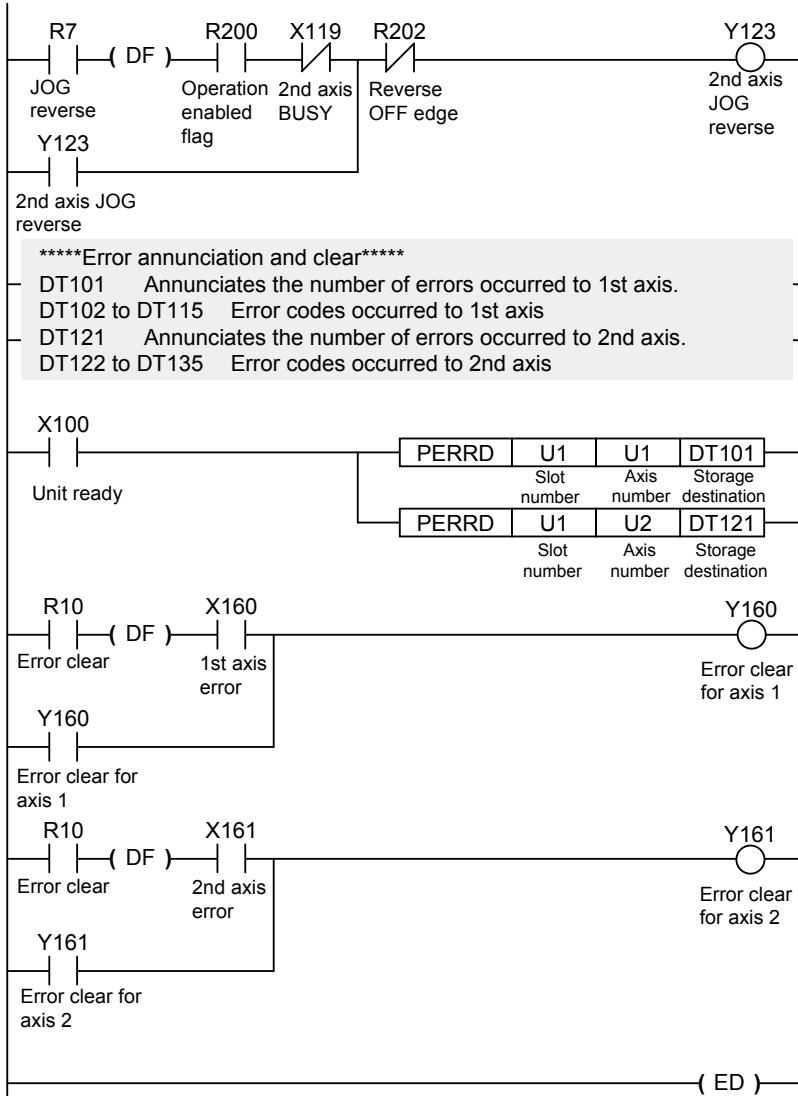

18.2.2 When Setting Positioning Data in Extended Area by Programming

Write positioning data in the extended area by programming.

Recalculating the positioning data is not necessary as the extended area is used.

Replace the part of the positioning start program in the sample program

■ Positioning start program

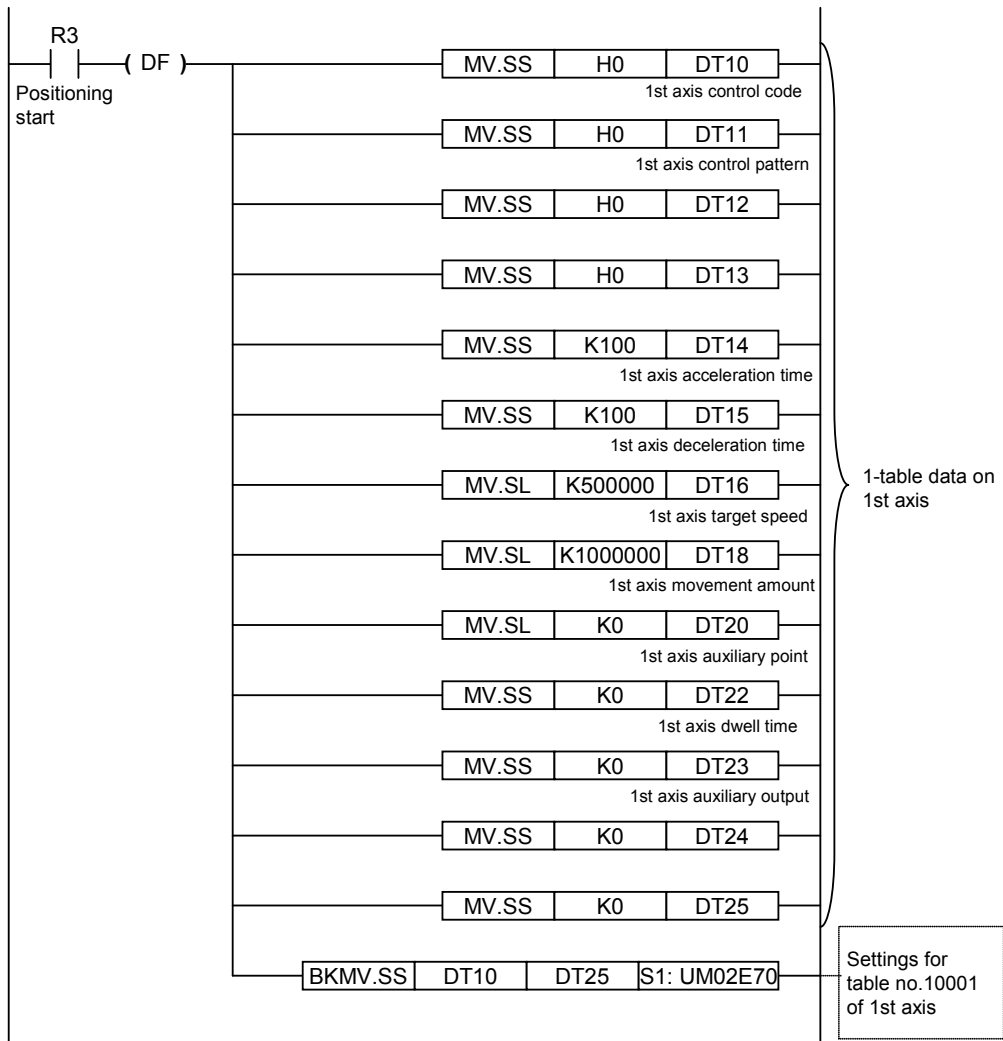

Sample program

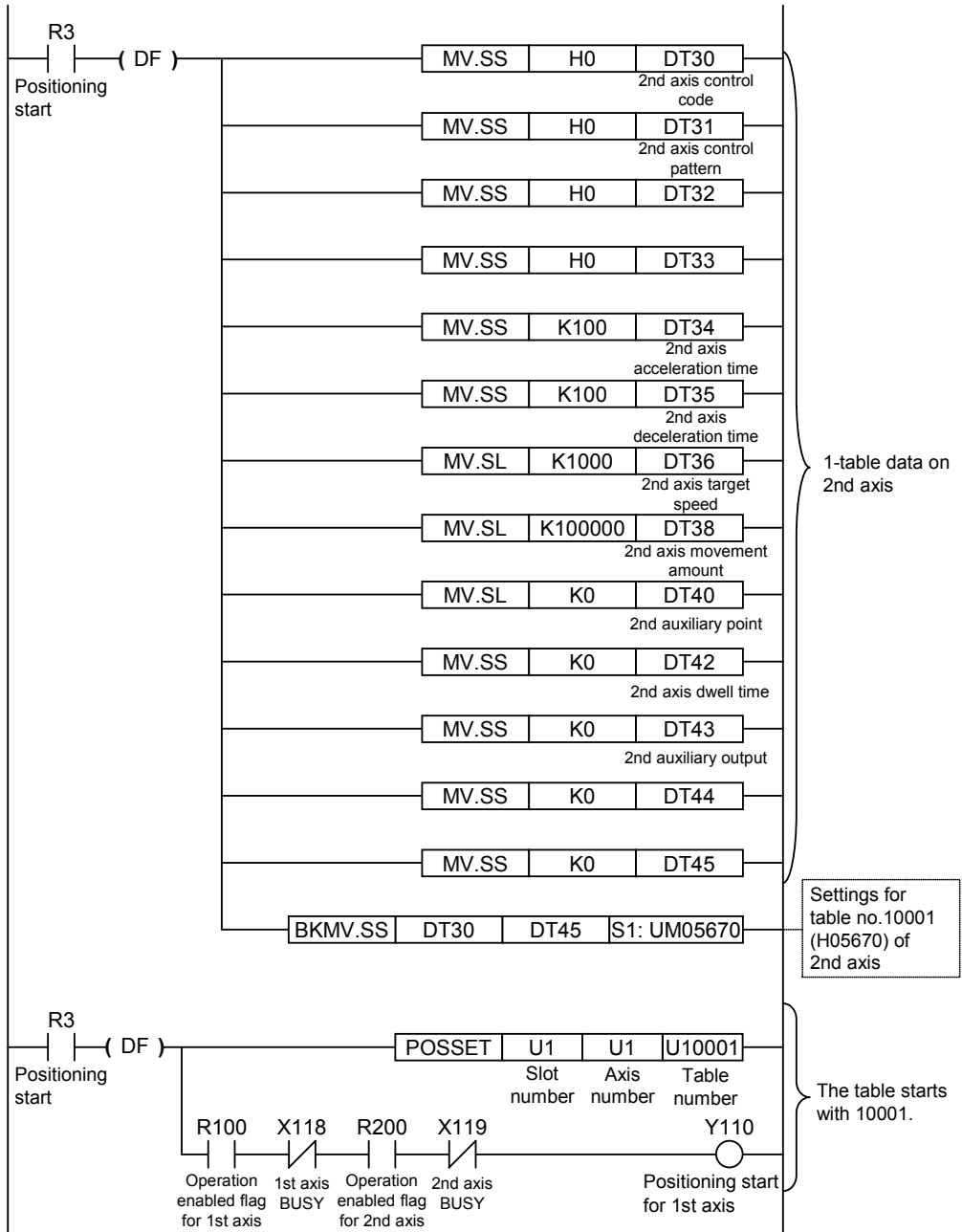

18.2.3 When Setting Positioning Data in Standard Area by Programming

Write positioning data in the standard area by programming.

Recalculating the positioning data is necessary after setting the positioning data.

Replace the part of the positioning start program in the sample program

■ Positioning start program

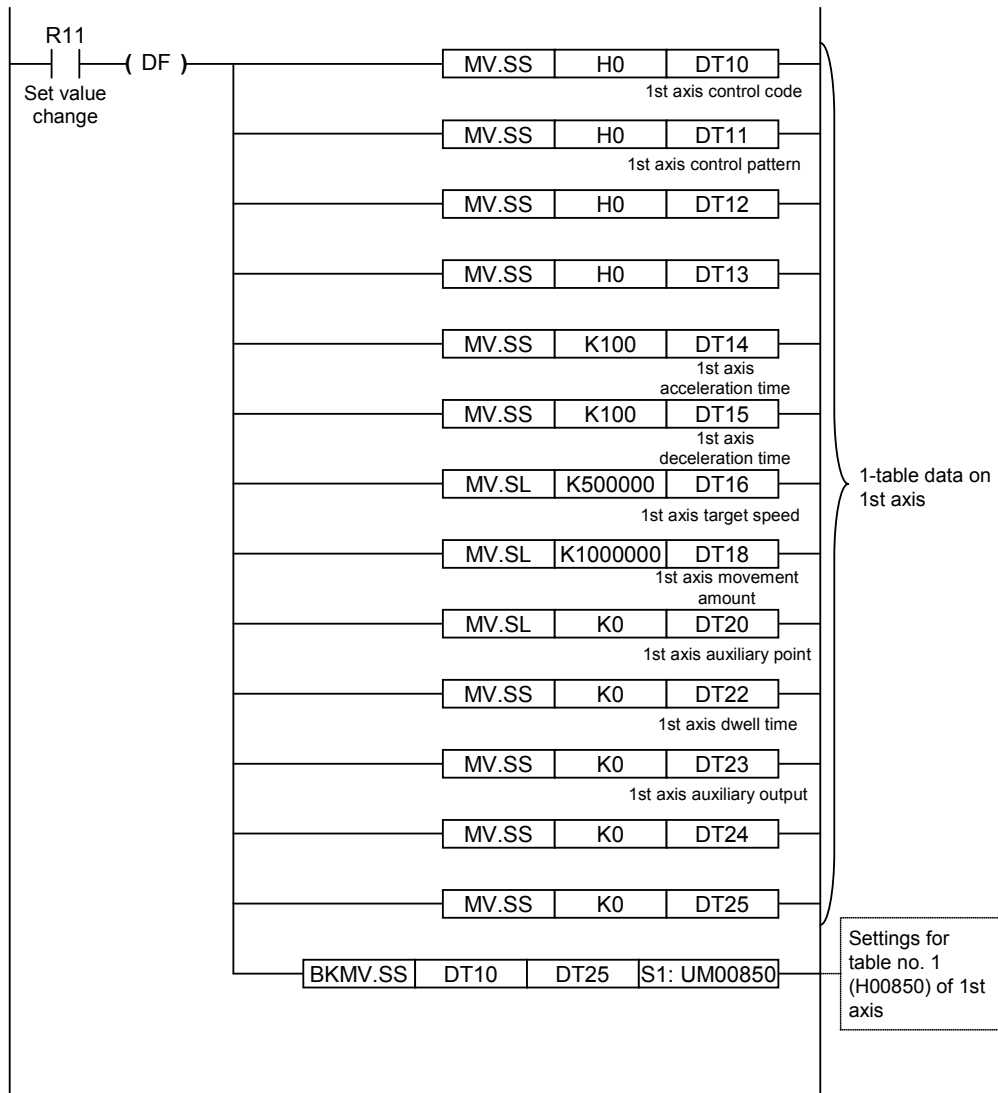

Sample program

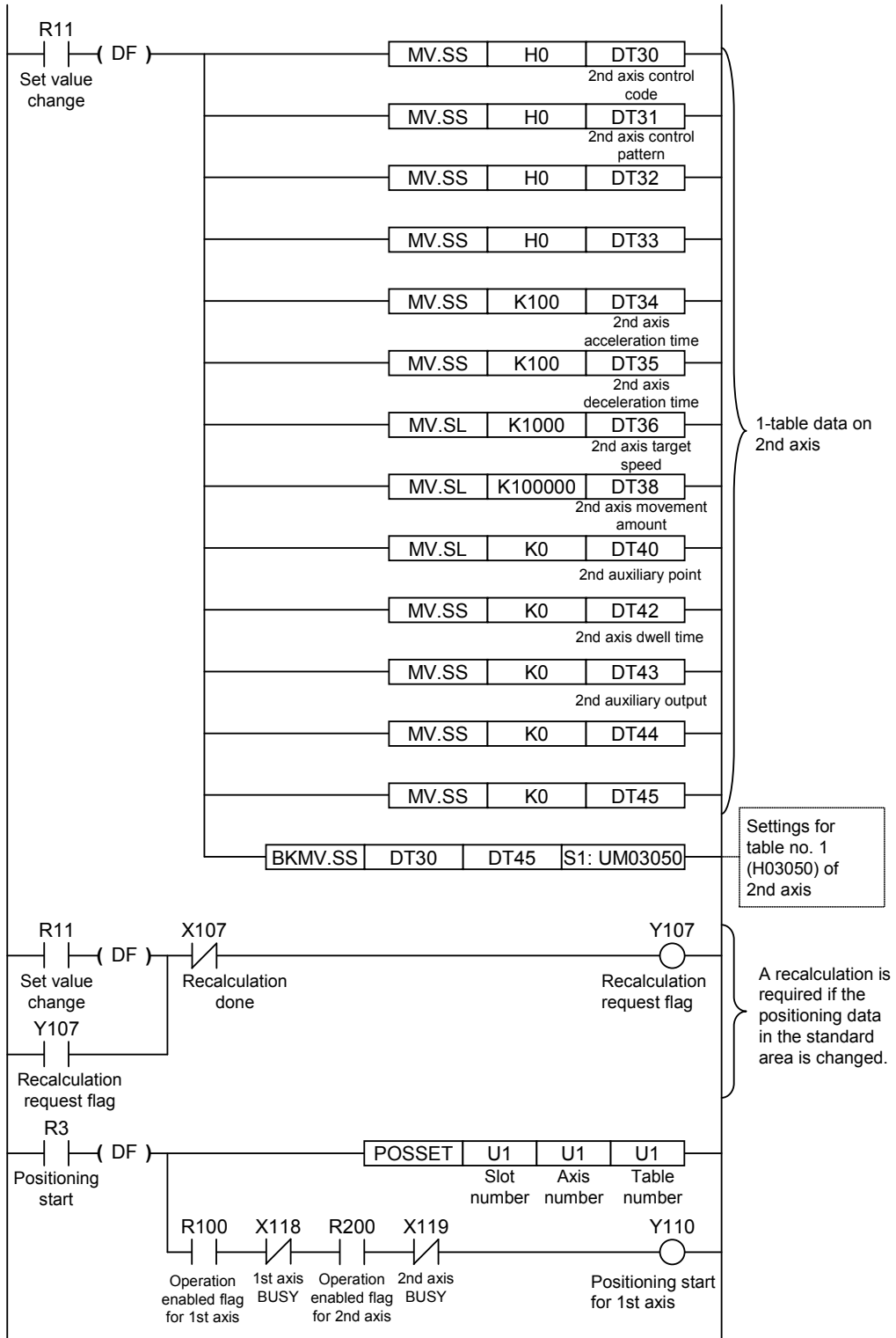

Record of changes

Manual No.	Date	Record of Changes
WUME-FP7POSP-01	Mar.2013	First Edition
WUME-FP7POSP-02	Jun.2015	Second Edition - Corrected sample programs. (18.2.2, 18.2.3) - Added new functions (Unit version Ver.1.3 or later) Positioning speed change function, Positioning movement amount change function (13.8, 13.9, 17.8) Input time constant change function (5.3.2, 17.6.2) - Change related to FPWINGR7 GUI (5.6, 6.1) - Error correction
WUME-FP7POSP-03	Mar. 2016	Third Edition - Added the functions related to synchronous control (Chapter 12) Phase specification clutch OFF function, Advance angle correction function, Cancel of synchronous control during operation, Rewriting cam patterns by programs - Increased the number of positioning tables (expansion area) (25 tables to 100 tables). - Error correction

Please contact

Panasonic Industrial Devices SUNX Co., Ltd.

■ Overseas Sales Division (Head Office): 2431-1 Ushiyama-cho, Kasugai-shi, Aichi, 486-0901, Japan

■ Telephone: +81-568-33-7861 ■ Facsimile: +81-568-33-8591

panasonic.net/id/pidsx/global

About our sale network, please visit our website.