

PROGRAMMABLE CONTROLLER
FP7 Analog Cassette
User's Manual

Safety Precautions

Observe the following notices to ensure personal safety or to prevent accidents.
To ensure that you use this product correctly, read this User's Manual thoroughly before use.
Make sure that you fully understand the product and information on safety.
This manual uses two safety flags to indicate different levels of danger.

WARNING

If critical situations that could lead to user's death or serious injury is assumed by mishandling of the product.

- Always take precautions to ensure the overall safety of your system, so that the whole system remains safe in the event of failure of this product or other external factor.
- Do not use this product in areas with inflammable gas. It could lead to an explosion.
- Exposing this product to excessive heat or open flames could cause damage to the lithium battery or other electronic parts.

CAUTION

If critical situations that could lead to user's injury or only property damage is assumed by mishandling of the product.

- To prevent excessive exothermic heat or smoke generation, use this product at the values less than the maximum of the characteristics and performance that are assured in these specifications.
- Do not dismantle or remodel the product. It could cause excessive exothermic heat or smoke generation.
- Do not touch the terminal while turning on electricity. It could lead to an electric shock.
- Use the external devices to function the emergency stop and interlock circuit.
- Connect the wires or connectors securely.
The loose connection could cause excessive exothermic heat or smoke generation.
- Do not allow foreign matters such as liquid, flammable materials, metals to go into the inside of the product. It could cause excessive exothermic heat or smoke generation.
- Do not undertake construction (such as connection and disconnection) while the power supply is on. It could lead to an electric shock.

Copyright / Trademarks

- This manual and its contents are copyrighted.
- You may not copy this manual, in whole or part, without written consent of Panasonic Industrial Devices SUNX Co., Ltd.
- Windows is a registered trademark of Microsoft Corporation in the United States and other countries.
- All other company names and product names are trademarks or registered trademarks of their respective owners.

Introduction

Thank you for buying a Panasonic product. Before you use the product, please carefully read the installation instructions and the users manual, and understand their contents in detail to use the product properly.

Types of Manual

- There are different types of users manual for the FP7 series, as listed below. Please refer to a relevant manual for the unit and purpose of your use.
- The manuals can be downloaded on our website:
http://industrial.panasonic.com/ac/e/dl_center/manual/ .

Unit name or purpose of use	Manual name	Manual code	
FP7 Power Supply Unit			
FP7 CPU Unit	FP7 CPU Unit Users Manual (Hardware)	WUME-FP7CPUH	
	FP7 CPU Unit Command Reference Manual	WUME-FP7CPUPGR	
	FP7 CPU Unit Users Manual (Logging Trace Function)	WUME-FP7CPULOG	
	FP7 CPU Unit Users Manual (Security Function)	WUME-FP7CPUSEC	
	Instructions for Built-in LAN Port	FP7 CPU Unit Users Manual (LAN Port Communication)	WUME-FP7LAN
	Instructions for Built-in COM Port	FP7 series Users Manual (SCU communication)	WUME-FP7COM
	FP7 Extension Cassette (Communication) (RS-232C/RS485 type)		
	FP7 Extension Cassette (Communication) (Ethernet type)	FP7 series Users Manual (Communication cassette Ethernet type)	WUME-FP7CCET
	FP7 Extension (Function) Cassette Analog Cassette	FP7 Analog Cassette Users Manual	WUME-FP7FCA
	FP7 Digital Input/Output Unit	FP7 Digital Input/Output Unit Users Manual	WUME-FP7DIO
FP7 Analog Input Unit	FP7 Analog Input Unit Users Manual	WUME-FP7AIH	
FP7 Analog Output Unit	FP7 Analog Output Unit Users Manual	WUME-FP7AOH	
FP7 High-speed counter Unit	FP7 High-speed counter Unit Users Manual	WUME-FP7HSC	
FP7 Pulse Output Unit	FP7 Pulse Output Unit Users Manual	WUME-FP7PG	
FP7 Positioning Unit	FP7 Positioning Unit Users Manual	WUME-FP7POSP	
FP7 Serial Communication Unit	FP7 series Users Manual (SCU communication)	WUME-FP7COM	
PHLS System	PHLS System Users Manual	WUME-PHLS	
Programming Software FPWIN GR7	FPWIN GR7 Introduction Guidance	WUME-FPWINGR7	

Table of Contents

1. Unit Functions and Restrictions	1-1
1.1 Unit Functions and How They Work	1-2
1.1.1 Functions of Cassettes	1-2
1.1.2 Types and Model Numbers of Cassettes	1-2
1.2 Restrictions on Combinations of Units	1-3
1.2.1 Restrictions on Power Consumption	1-3
1.2.2 Applicable Versions of Unit and Software	1-3
1.2.3 Restrictions on the Combination of Extension Cassettes	1-3
2. Specifications	2-1
2.1 Analog I/O Cassette and Analog Input Cassette	2-2
2.1.1 Input Specifications (AFP7FCA21 / AFP7FCAD2)	2-2
2.1.2 Output Specifications (AFP7FCA21)	2-3
2.1.3 Switch Settings	2-4
2.1.4 Wiring	2-5
2.1.5 Input Conversion Characteristics (AFP7FCA21 / AFP7FCAD2)	2-7
2.1.6 Output Conversion Characteristics (AFP7FCA21)	2-8
2.2 Thermocouple Input Cassette	2-10
2.2.1 Input Specifications	2-10
2.2.2 Switch Settings	2-10
2.2.3 Wiring	2-11
2.2.4 Input Conversion Characteristics	2-11
3. I/O Allocation and Programs	3-1
3.1 I/O Allocation	3-2
3.1.1 I/O Allocation	3-2
3.2 Sample Programs	3-3
3.2.1 Example of Analog Input/Output	3-3

3.2.2 Example of Thermocouple Input 3-3

1

Unit Functions and Restrictions

1.1 Unit Functions and How They Work

1.1.1 Functions of Cassettes

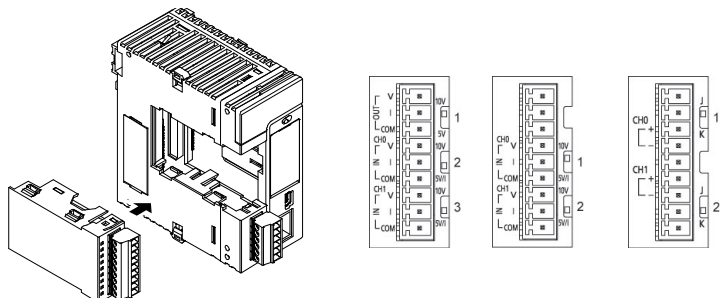

■ **Using these cassettes attached to the CPU unit enables analog I/O control.**

- An analog input and analog output can be controlled by attaching these extension cassettes to the CPU unit.
- It is selectable from three types of cassettes in accordance with the intended use.

■ **Input and output with simple programs**

- For input data, a digital conversion value (0 to 4000) is read as an input device (WX).
- For output data, a digital value (0 to 4000) is converted to analog output data by being written into an output device (WY).

■ **The input and output range is switchable.**

- The range can be switched with the switches on each cassette. The current input is switched according to wirings.

■ **Equipped with the thermocouple disconnection alarm function (Thermocouple input cassette)**

- When a thermocouple is disconnected, the value is digitally converted to the fixed value (K8000) so that you can determine the situation is not normal.

1.1.2 Types and Model Numbers of Cassettes

Name		Model No.	
FP7 Extension Cassette (Function Cassette)	Analog I/O cassette	2-ch Input, 1-ch output	AFP7FCA21
	Analog input cassette	2-ch input	AFP7FCAD2
	Thermocouple input cassette	2-ch input	AFP7FCTC2

1.2 Restrictions on Combinations of Units

1.2.1 Restrictions on Power Consumption

The internal current consumption of the unit is as follows. Make sure that the total current consumption is within the capacity of the power supply with consideration of all other units used in combination with this unit.

Name	Specifications		Model No.	Current consumption
FP7 Extension Cassette (Function Cassette)	Analog I/O cassette	2-ch Input, 1-ch output	AFP7FCA21	75 mA or less
	Analog input cassette	2-ch input	AFP7FCAD2	40 mA or less
	Thermocouple input cassette	2-ch input	AFP7FCTC2	45 mA or less

1.2.2 Applicable Versions of Unit and Software

For using the above function cassettes, the following versions of unit and software are required.

Item	Applicable version
FP7 CPU unit	Ver.2.0 or later
Programming tool software FPWIN GR7	Ver.1.4 or later

1.2.3 Restrictions on the Combination of Extension Cassettes

There are following restrictions depending on units and cassettes to be used.

Unit type	Number of attachable cassettes	Attachable extension cassettes		
		Communication cassette AFP7CCS* AFP7CCM*	Communication cassette AFP7CCET	Function cassette AFP7FC*
CPU Unit	Max. 1 unit	●	●	●
Serial Communication Unit	Max. 2 units per unit	●	Not attachable	Not attachable

2

Specifications

2.1 Analog I/O Cassette and Analog Input Cassette

2.1.1 Input Specifications (AFP7FCA21 / AFP7FCAD2)

■ Input specifications

Items	Description	
No. of input points	2 channels (non-insulated between channels)	
Input range	Voltage	0-10 V, 0-5 V (Can be set individually. Switchable)
	Current	0 -20 mA
Digital conversion value	K0 - K4000 (Note 1)	
Resolution	1/4000 (12-bit)	
Conversion speed	1 ms/channel	
Total accuracy	±1% F.S. or less (0 - 55 °C)	
Input impedance	Voltage	1 MΩ
	Current	250 Ω
Absolute max. input	Voltage	-0.5 V, +15 V (Voltage input)
	Current	+30 mA (Current input)
Insulation method	Between analog input terminal and internal digital circuit part: Transformer insulation, isolation IC insulation Between analog input terminal and analog output terminal: Transformer insulation, isolation IC insulation	

Note1) When the analog input values exceed the upper and lower limits of the input range, the digital values maintain the upper and lower limit values.

(Note 2) Because of 12-bit resolution, the higher 4 bits of digital conversion value are always zero.

(Note 3) The time shown in the figure below is required to reflect analog input values in the input device area (WX) read by the CPU unit.

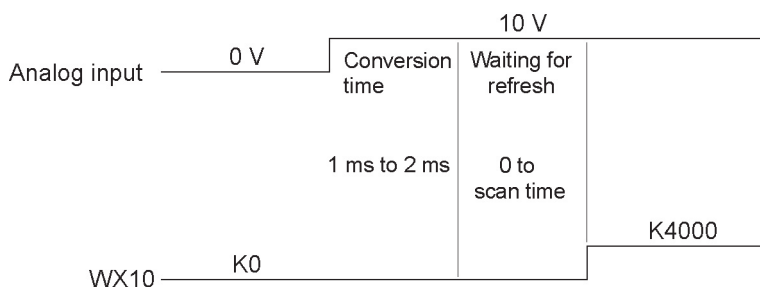

(Note 4) Averaging is not processed within the cassettes. Perform averaging with programs as necessary.

2.1.2 Output Specifications (AFP7FCA21)

■ Output specifications

Items		Description
No. of output points		1 channel/cassette
Output range	Voltage	0 – 10 V, 0 – 5 V (Switchable)
	Current	0 – 20 mA
Digital value		K0 - K4000
Resolution		1 / 4000 (12-bit)
Conversion speed		1 ms/channel
Total accuracy		±1% F.S. or less (0 - 55 °C)
Output impedance		0.5 Ω (Voltage output)
Output max. current		10 mA (Voltage output)
Output allowable load resistance		600 Ω or less (Current output)
Insulation method		Between analog output terminal and internal digital circuit part: Transformer insulation, isolation IC insulation Between analog output terminal and analog input terminal: Transformer insulation, isolation IC insulation

■ Precautions on the characteristics of analog I/O cassette

- When the power to the CPU unit turns on or off, voltage (equivalent to 2 V) may be output for approx. 2 ms from the analog I/O cassette. If it will be a problem on your system, take necessary measures externally to avoid the transitional condition, e.g. turning on PLC before external devices or turning off external devices before PLC.

2.1.3 Switch Settings

- Set the range selection switches on the cassette before wiring.

■ Range selection switches (AFP7FCA21)

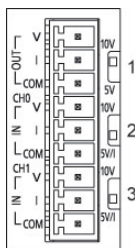

SW No.	Name	Voltage / Current I/O	
1	Output range selection switch (Note)	10 V	0 to +10 V
		5 V	0 to +5 V
2	CH0 input range selection switch	10 V	0 to +10 V
		5 V/I	0 to +5 V / 0 to +20 mA
3	CH1 input range selection switch	10 V	0 to +10 V
		5 V/I	0 to +5 V / 0 to +20 mA

When using it as analog current output, it works in either case, regardless of the setting of the switches.

■ Range selection switches (AFP7FCAD2)

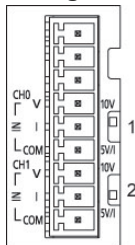

SW No.	Name	Voltage / Current input	
1	CH0 input range selection switch	10 V	0 to +10 V
		5 V/I	0 to +5 V / 0 to +20 mA
2	CH1 input range selection switch	10 V	0 to +10 V
		5 V/I	0 to +5 V / 0 to +20 mA

■ Switch on the back of the cassette

- Always turn OFF the switch mounted on the printed wiring board on the back of the cassette.

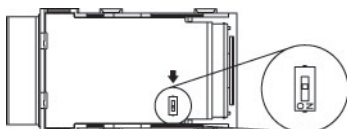

2.1.4 Wiring

■ Wiring Diagram

Voltage input

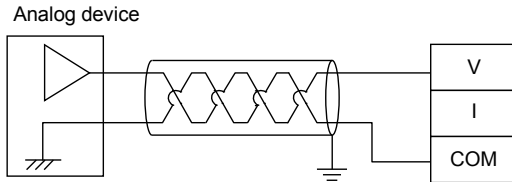

Current input

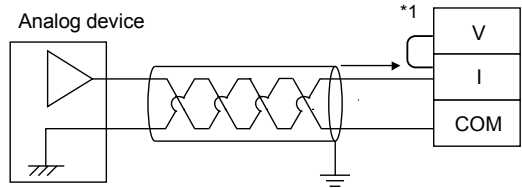

*1: For the current input, short-circuit the V and I terminals.

Voltage output

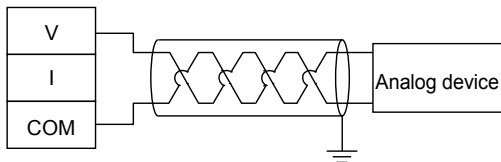

Current output

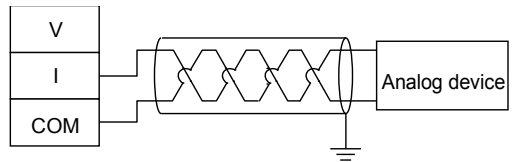

■ Precautions on wiring

- Use double-core twisted-pair shielded wires. It is recommended to ground them. However, depending on the conditions of the external noise, it may be better not to ground the shielding.
- Do not have the analog input wiring close to AC wires, power wires, or load. Also, do not bundle it with them.
- Do not have the analog output wiring close to AC wires, power wires, or load. Also, do not bundle it with them.
- On the output circuit, a voltage amplifier and a current amplifier is connected in parallel to one D/A converter IC. Do not connect an analog device to the voltage output terminal and current output terminal of the same channel simultaneously.

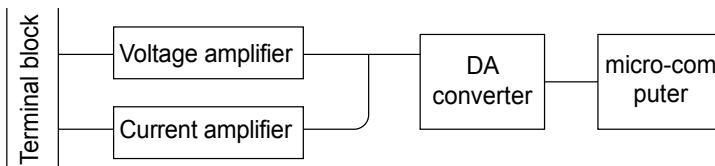

■ Terminal layout (AFP7FCA21)

Voltage input

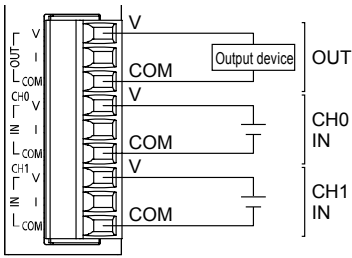

Current input

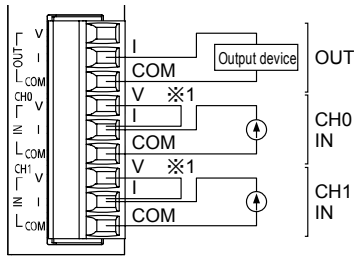

*1: Connect the V and I terminals for using it as current input.

■ Terminal layout (AFP7FCAD2)

Voltage input

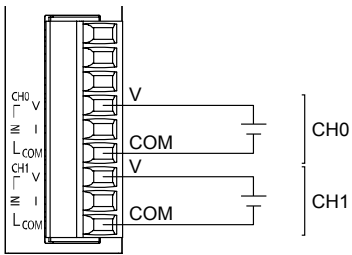

Current input

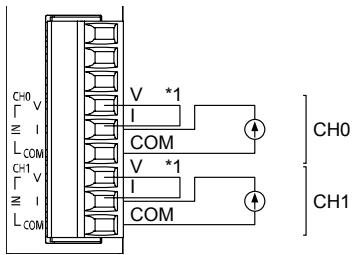

*1: Connect the V and I terminals for using it as current input.

2.1.5 Input Conversion Characteristics (AFP7FCA21 / AFP7FCAD2)

■ **0V to 10V DC input**

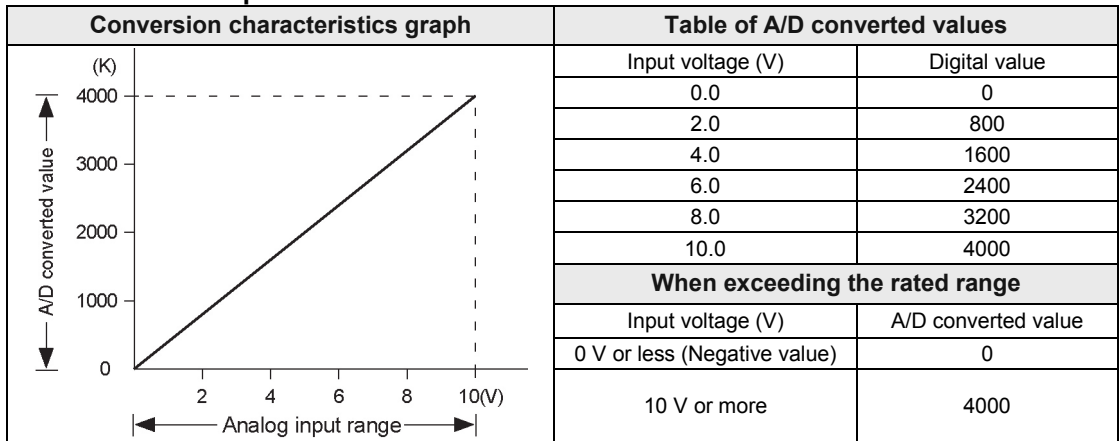

■ **0V to 5V DC input**

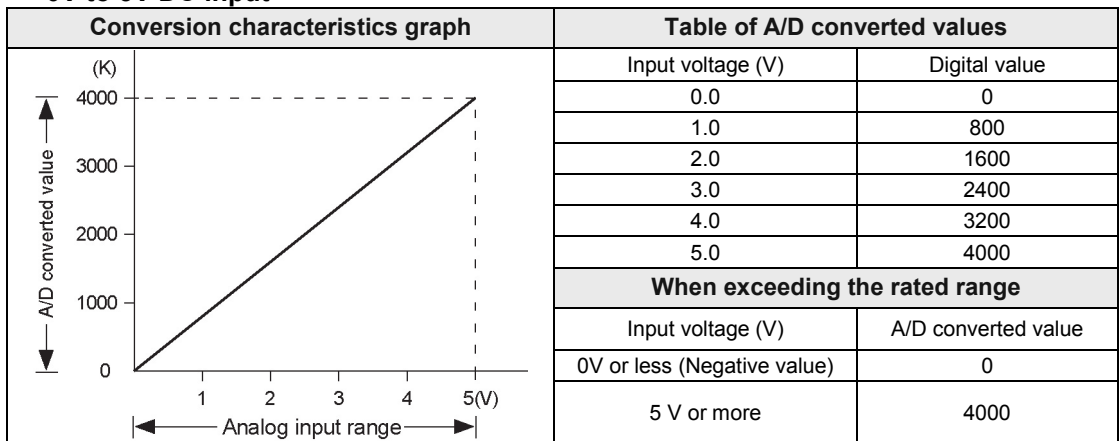

■ **0mA to 20mA DC input**

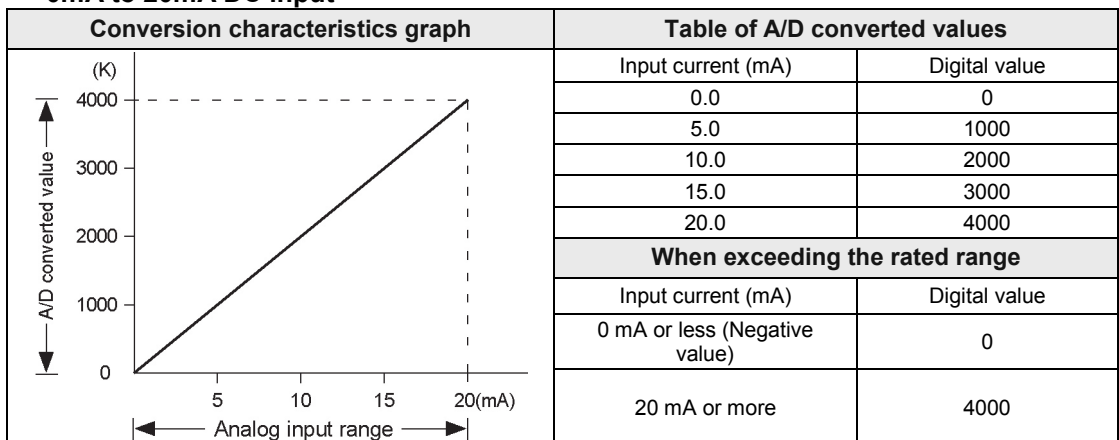

2.1.6 Output Conversion Characteristics (AFP7FCA21)

■ 0V to 10V DC output

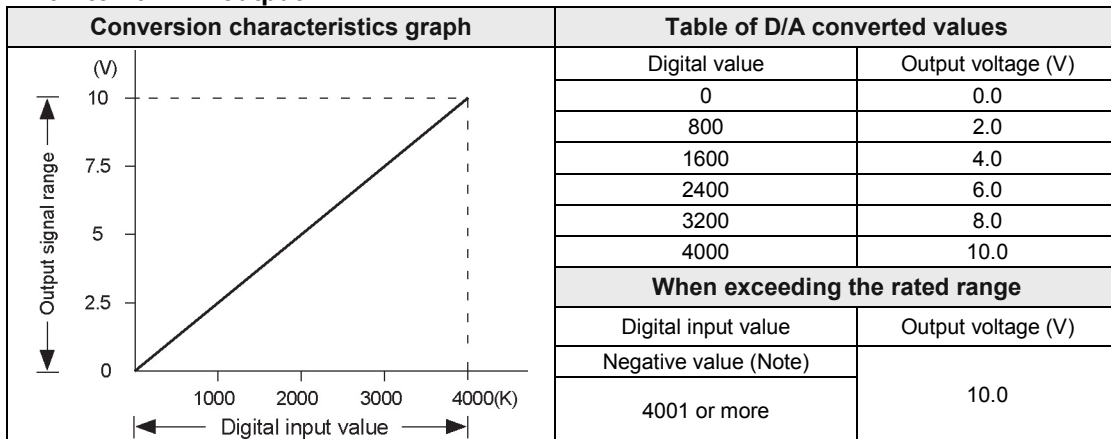

(Note) Digital input values are processed as unsigned 16-bit data (US).

■ 0V to 5V DC output

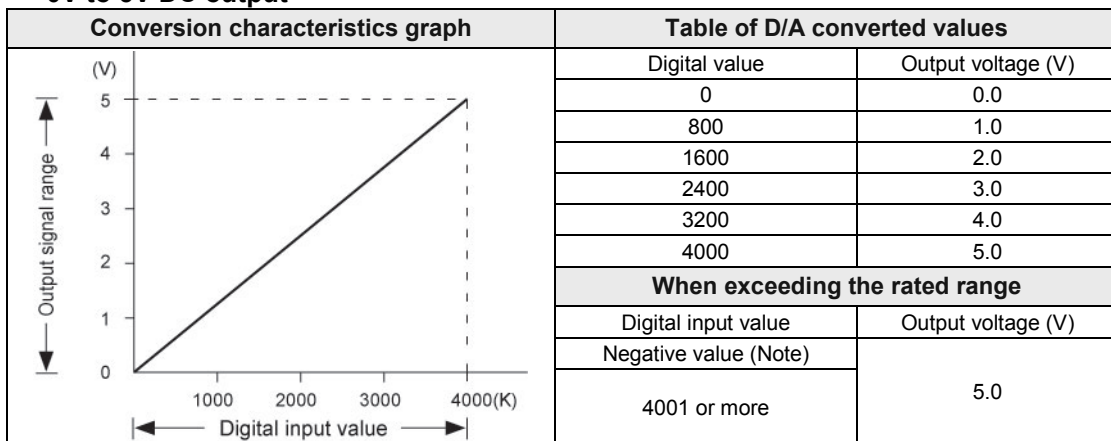

(Note) Digital input values are processed as unsigned 16-bit data (US).

■ 0mA to 20mA output

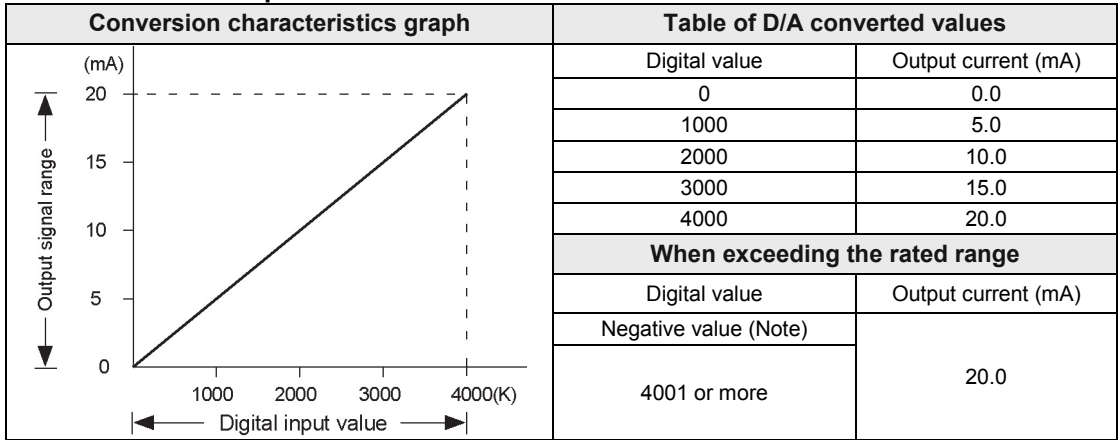

(Note) Digital input values are processed as unsigned 16-bit data (US).

2.2 Thermocouple Input Cassette

2.2.1 Input Specifications

■ Input specifications

Items	Description
No. of input points	2 channels (insulated between channels)
Input range	Thermocouple type K (-50.0 to 500.0 °C), Thermocouple type J (-50.0 to 500.0 °C)
Digital value	In normal condition K – 500 to K5000
	When exceeding rated range K – 501, K5001 or K8000
	When wire is broken K8000 (Note 1)
	When getting data ready K8001 (Note 2)
Resolution	0.2 °C (The indication is 0.1 °C by the software averaging procedure.) (Note 3)
Conversion speed	100 ms / 2 channels
Total accuracy	0.5% F.S. + Cold junction error 1.5 °C
Input impedance	344 kΩ
Insulation method	Transformer insulation, isolation IC insulation

(Note 1) When the wire of thermocouple is broken or disconnected, the digital value will change to K8000 within 70 seconds. For replacing the thermocouple, program a process for avoiding a risk that would be resulted from the disconnecting.

(Note 2) From the Power-on to the converted data Ready, the digital conversion value will be K8001. Make a program not to use the data in the meantime as conversion values.

(Note 3) Although the resolution of the hardware is 0.2 °C, it will be a conversion value by 0.1 °C by the internal averaging procedure.

2.2.2 Switch Settings

- Set the range selection switches on the cassette before wiring.

■ Thermocouple selection switches (AFP7FCTC2)

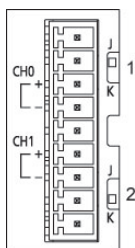

SW No.	Name		Thermocouple
1	CH0 thermocouple selection switch (Note)	J	Type J
		K	Type K
2	CH1 thermocouple selection switch (Note)	J	Type J
		K	Type K

(Note) For the thermocouple selection switch, the setting at the time of power-on is effective for the operation. Note the setting will not be updated even if the switch is changed during the operation.

■ Switch on the back of the cassette

- Always turn OFF the switch mounted on the printed wiring board on the back of the cassette.

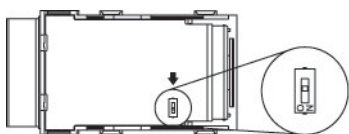

2.2.3 Wiring

■ Precautions on wiring

- Keep the space more than 100 mm between the input line and the power line/high-voltage line.



- It is recommended to ground the unit using the shielded compensating lead wire.

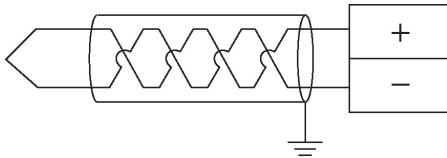

■ Terminal layout (AFP7FCTC2)

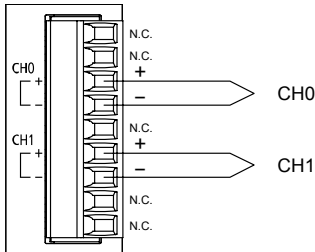

(Note) The N.C. terminals are used by the system. Do not connect anything.

2.2.4 Input Conversion Characteristics

■ Range of Thermocouples type K and J

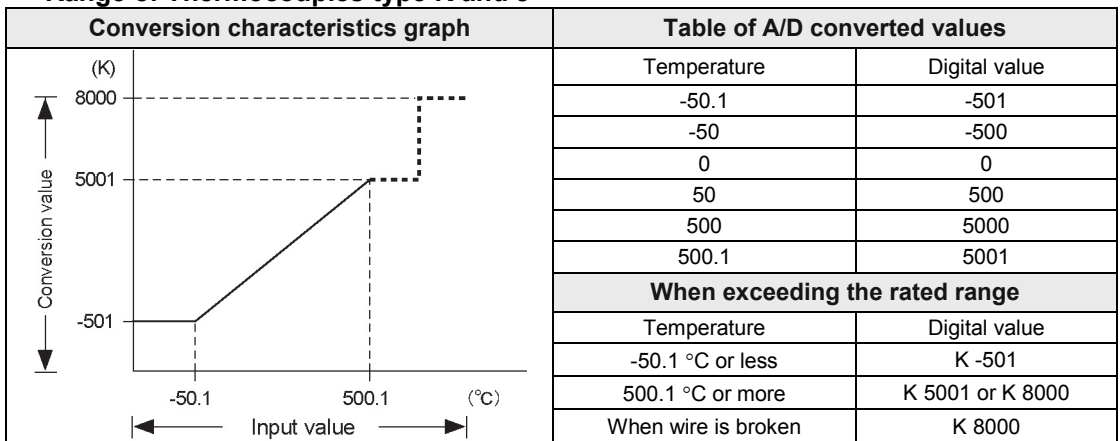

3

I/O Allocation and Programs

3.1 I/O Allocation

3.1.1 I/O Allocation

- The I/O areas of the CPU unit are allocated to each cassette.
- An area of one word (16 points) is allocated to a channel.

Specifications		Input		Output
		CH0	CH1	CH0
Analog I/O cassette	2-ch Input, 1-ch output	WX2	WX3	WY2
Analog input cassette	2-ch input	WX2	WX3	-
Thermocouple input cassette	2-ch input	WX2	WX3	-

(Note) The starting numbers of I/O contacts of each unit including the CPU unit can be changed by the setting of tool software.

3.2 Sample Programs

3.2.1 Example of Analog Input/Output

- For analog input, digital conversion values are read from the device area (WX) of the input relay.
- For analog output, digital conversion values are written into the device area (WY) of the output relay.

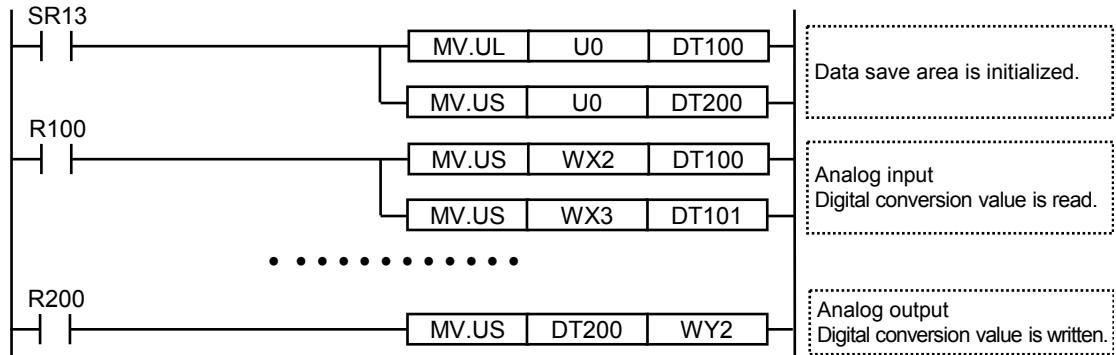

3.2.2 Example of Thermocouple Input

- For thermocouple input, digital conversion values are read from the device area (WX) of the input relay.
- Make a program not to use the values as normal converted data until the completion of data preparation at the time of power-on, or when disconnecting is detected.

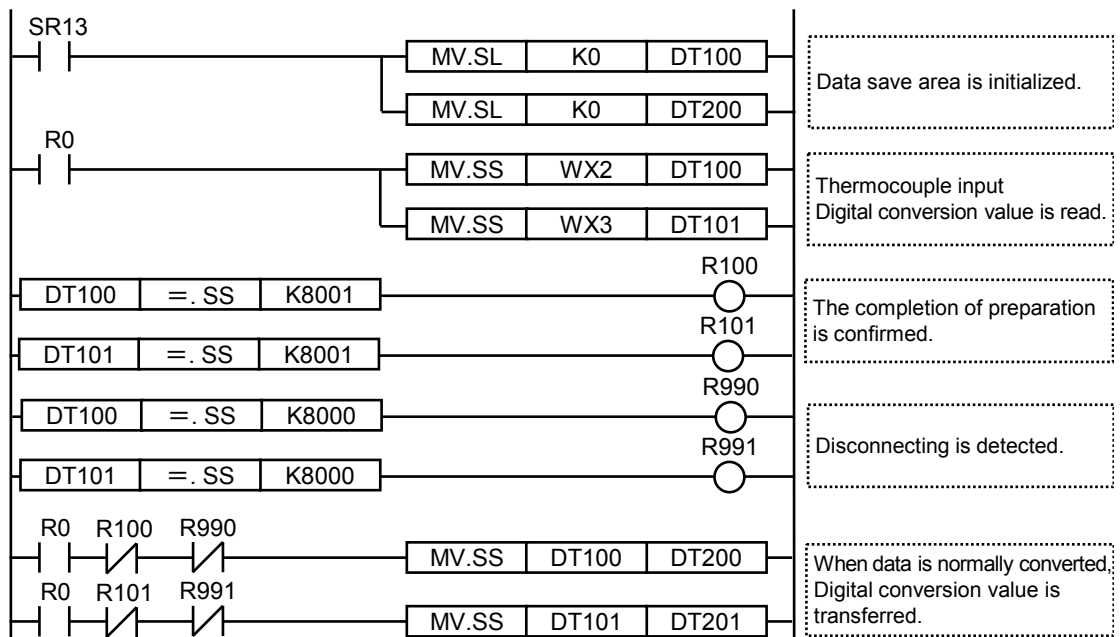

Record of changes

Manual No.	Date	Record of Changes
WUME-FP7FCA-01	MAR.2014	First Edition

Please contact

Panasonic Industrial Devices SUNX Co., Ltd.

■ Overseas Sales Division (Head Office): 2431-1 Ushiyama-cho, Kasugai-shi, Aichi, 486-0901, Japan

■ Telephone: +81-568-33-7861 ■ Facsimile: +81-568-33-8591

panasonic.net/id/pidsx/global

About our sale network, please visit our website.