

Panasonic

PROGRAMMABLE LOGIC CONTROLLER FP7 SERIES





FP7: Panasonic know-how inside!

Panasonic has a large number of factories worldwide. All our industry PLCs contain the experience and expertise of our machine and production engineers.

FP7: very fast & flexible

One of the fastest PLCs in the world: 11ns per program step! Program capacity of up to 220.000 steps, data memory of up to 500.000 words, and up to 32GB expandable memory using SDHC card.

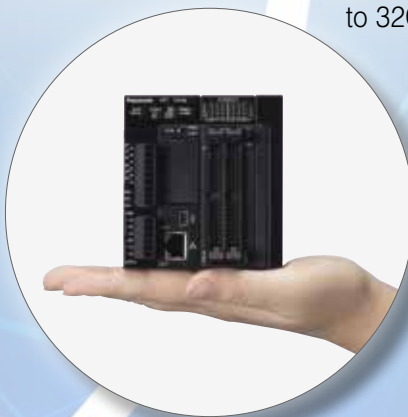

FP7: very small & powerful



FP7: connects worlds

Programming, monitoring, remote control and communication with other automation devices is possible all over the world.

FP7: green & clean

Panasonic specifies 14 forbidden and hazardous substances, which are not used in our products. We permit less than one-tenth of the level allowed by the RoHS guideline for the 6 most important hazardous substances and we have forbidden the use of another 8 hazardous substances in our products that are not even covered by the RoHS guideline.

FP7 features

Local & remote connectivity

Dedicated to the total integration into Web applications

Security & reliability

Provides seven different security levels, automatically stores backup programs and allows users to update programs only after a functional check

Compact design

Incorporates the functionality and performance of a modular PLC in an outstanding compact format

Traceability

Traces the values of variables over a certain time frame during program execution

FP7: Seven steps to higher efficiency



Maintenance

Integrates several features that facilitate maintenance, diagnostics and troubleshooting

Advanced motion control (cam & gear)

Offers a variety of control options, from simple position control to synchronized control of multiple axes to advanced cam control and gearing

Performance

Equipped with a large memory capacity (up to 220k program steps or up to 500k data words) and a high-speed processor (11ns/step)

Content

FP7 overview	2	Performance	9
Seven steps	3	Advanced motion control	10
Compact design	5	FP7 lineup	11
Local & remote connectivity	5	FP7 units and accessories	12-18
Security & reliability	6	Control FPWIN Pro	19-20
Traceability	7	Product numbers	21-22
Maintenance	8	Further Panasonic products	23



Compact design

The FP7 represents the top of the range of our PLCs and incorporates all the functionality and performance of a modular PLC in an outstanding compact format with a height of only 90mm!

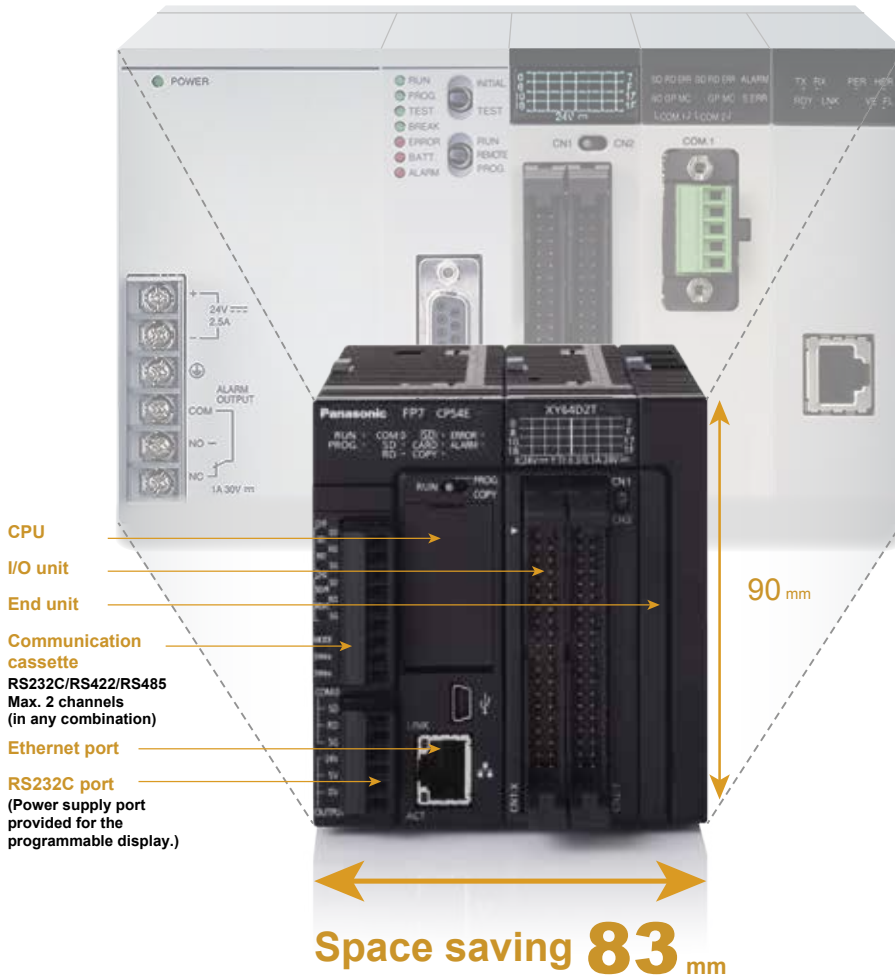

No power supply unit needed

No power supply unit is needed if the CPU is directly connected to DC power. Expansion units are clipped together without backplane.

- Reduced costs
- Smaller footprint

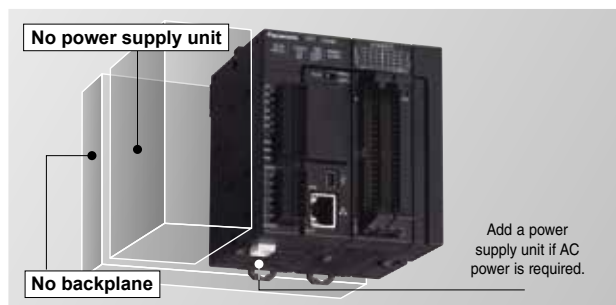

No communication unit needed

Enhancing communication features can be added using communication cassettes.

- Reduced costs
- Smaller footprint





Local & remote connectivity

The FP7 is dedicated to the total integration into Web applications. The standard CPU boards with Ethernet interface offer connectivity without limits, from remote programming to monitoring and data logging to FTP server and Modbus TCP.

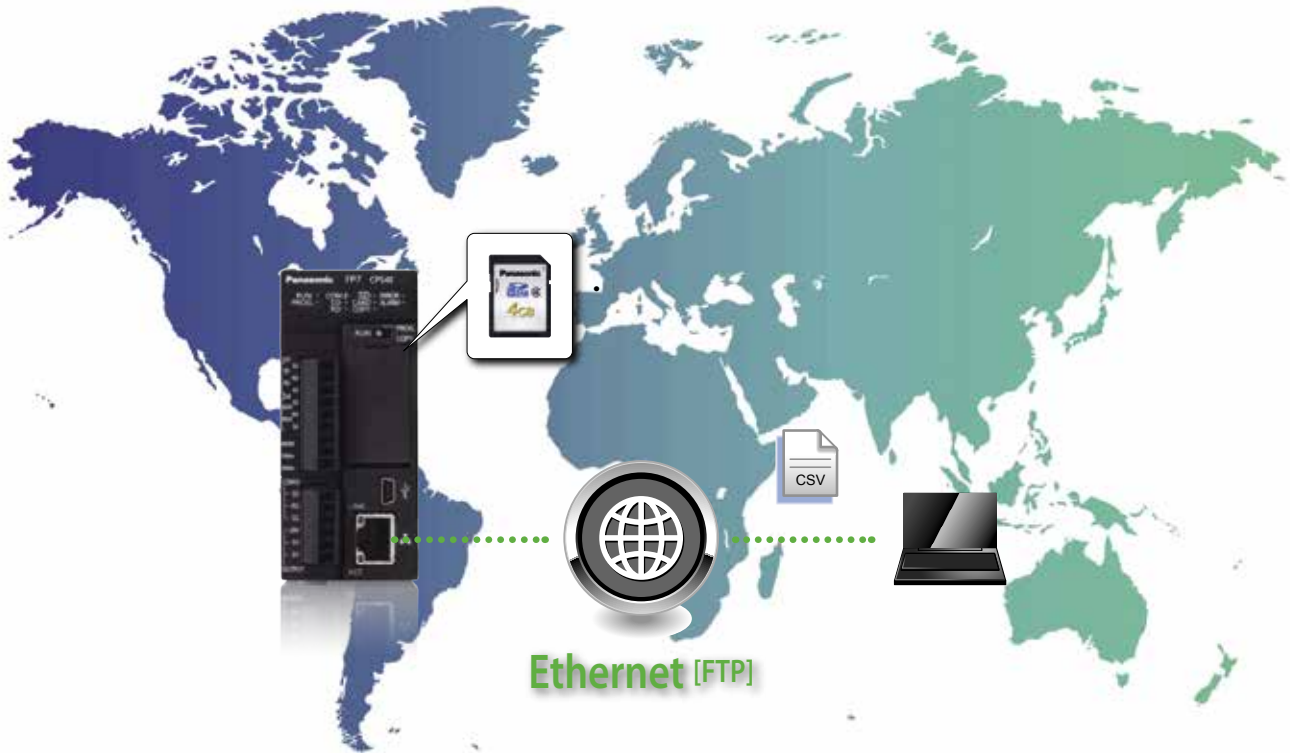

FP Web-Server main features:

Web-Server:

- PLC data presented as HTML pages
- Access via standard Internet browser
- HTML entry field for PLC data change
- Optional password protection
- Java applet functions library

Data logger:

- Logging of PLC data and saving it on an SD memory card or transmitting it via FTP (only possible when FP-WEBEXP is attached)

E-mail:

- PLC can send e-mails, also with PLC data attachments
- E-mail server access via LAN or Internet dial-up
- PLC defined or pre-stored mail text

RS232C device server:

- Ethernet ↔ RS232C conversion (MEWTOCOL)
- Transparent RS232C data tunnelling via Ethernet
- Programming and visualization access via Ethernet

Modem/Ethernet gateway:

- FP Web-Server can be dialed up via modem for local or network access
- One remote gateway for multiple FP Web-Servers in a local Ethernet network
- Remote password handling

Modbus-TCP communication:

- Modbus-TCP server or client for a PLC



3

Security & reliability

The PLC programs can be password protected. Additionally, seven different security levels can be set! The CPU unit can store two programs. In the event of fault, no SD memory card is needed to return to a previously saved backup program.

Built-in program backup

- Production can resume in the event of fault
- Original program is immediately to hand

Two program areas

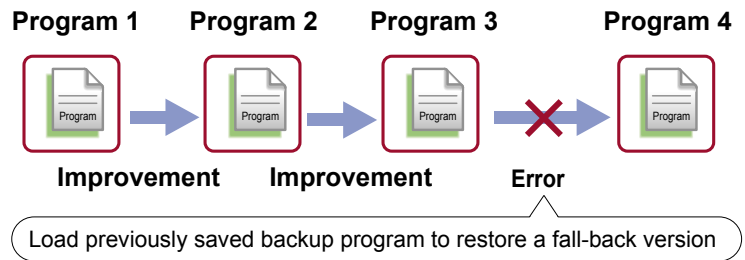
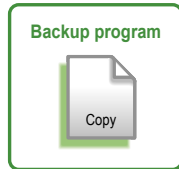

Update PLC program only after functional check

- Operation can be tested on SD memory card

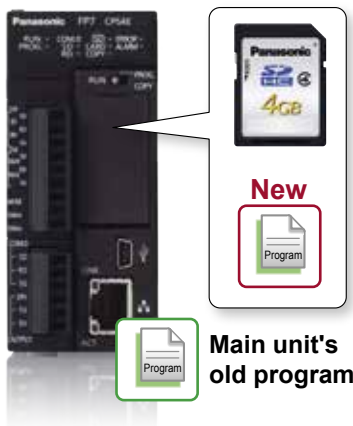

1 Execute new program in SD memory card on FP7.



2 Check operations under new program.



3 Update main unit's old program to the new program if program functions correctly.

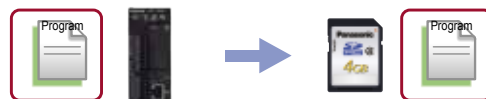

4

Traceability

Operational and program editing events are logged. Automatic logs of program download and upload are useful, especially for program debugging.

Automatic recording of program change history

- Useful for debugging



Date of occurrence	Time	Trigger
2012/11/21	14:05:35	Power: ON
2012/11/21	14:07:13	Open cover
2012/11/21	14:20:25	Insert SD memory card.
2012/11/21	14:30:19	Close cover
2012/11/21	14:31:00	Download program
2012/11/21	14:33:10	Switch operation mode to RUN
2012/11/21	14:35:12	Program edition during RUN
2012/11/21	14:35:32	Upload program
2012/11/21	14:40:07	Power: OFF

Visualization tool FP Data Analyzer

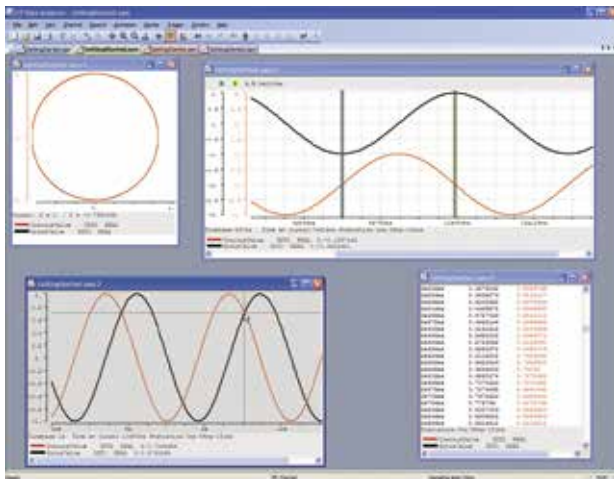

The FP Data Analyzer can be used to store recorded PLC data and to analyze it in offline mode. The tool can be used for:

- Failure diagnostics
- Finding and isolating failures
- Performance analyses
- System optimization
- Scan time reduction
- Documenting support
- Machine maintenance
- Improving development

Fields of application

- Diagnosing unexpected behavior and errors on a machine
With the FP Data Analyzer, you can connect to a PLC, configure data to be analyzed and set a trigger to start analysis when the error flag occurs. You can also set a pre-trigger time to check events that occurred before the error.
- Archiving of historical data from a plant
You can connect the tool to a PLC and read the data to be archived. You can set the scan time to read the data once a day or every hour. You can also write a small function block that archives the data in an array in the PLC's memory. If the memory is full, you can connect the FP Data Logger to the PLC, upload the data, archive and analyze it.
- Observing multiple axis movement
Using the XY mode, you can observe multiple axis movements achieved by linear or circular interpolation.



Maintenance

The FP7 integrates several features that facilitate maintenance, diagnostics and troubleshooting. Set a maintenance schedule that is based on automatic measurement of contact switching cycles or overall ON time.

Hour meter operation

- Indication of maintenance schedules for PLC and peripheral equipment



Hour meter
Monitoring of I/O contacts

Monitoring of I/O contacts

Automatic logging of total ON times and switching cycles of connected input and output devices allows maintenance schedules for sensors, relays, motors, etc. to be optimized.

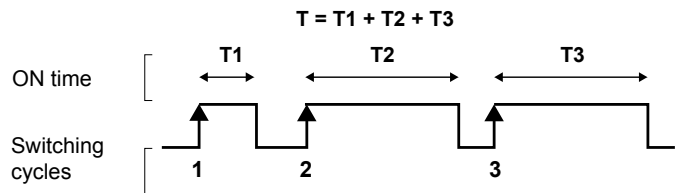

PLC hour meter

By estimating the PLC's remaining life from the total number of operating hours an optimal predictive maintenance can be established with servicing performed during planned downtime.

Data backup without battery

- Simplified maintenance of equipment

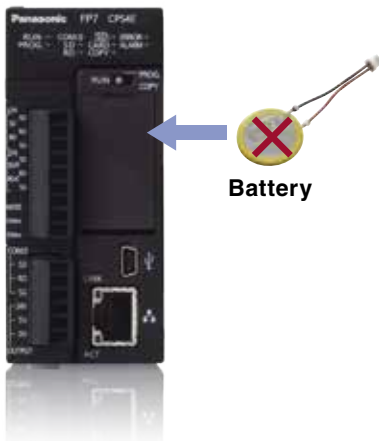

Item	Without battery	With battery
Program holding	Yes	Yes
Data register holding	Yes	Yes
Clock/calendar operation	No*	Yes

* Clock/calendar operation can be held for about a week if the equipment is switched off.

The built-in clock/calendar function can be adjusted via Ethernet.

Performance

The FP7 has a large memory capacity for program and data (up to 220k program steps or up to 500k data words) and a high-speed processor (11ns/step). Control FPWIN Pro is (up- and downward) compatible with all Panasonic PLCs.

Shareable program and data memory

- Both expandable when more capacity needed
- No need to purchase upgrade models

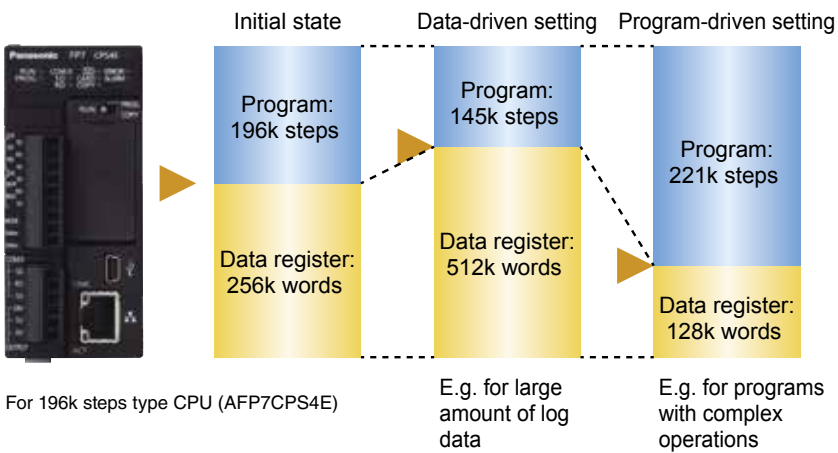

AFP7CPS41E

Program	Data registers
234k steps approx.	64k words approx.
221k steps approx.	128k words approx.
196k steps approx.	256k words approx.
145k steps approx.	512k words approx.
52k steps approx.	976k words approx.

AFP7CPS31E/AFP7CPS3

Program	Data registers
120k steps approx.	128k words approx.
96k steps approx.	256k words approx.
64k steps approx.	416k words approx.
32k steps approx.	576k words approx.

Note: For data registers (DT), data up to 256k words can be backed up.



New analog units with high-speed DA and AD conversion

- Conversion speed 20 times faster than in previous models
- High-accuracy control
- Noise-resistant with isolated channels
- Multi-channel type (8 channels) available with high-speed processing



Advanced motion control (cam & gear)

FP7 programmable controllers are perfectly integrated with MINAS A5 servo drivers for accurate and sophisticated control in applications with up to 64 axes.

Besides, it is possible to set linear or sinusoidal acceleration and deceleration; startup/stop speed changes are easy to accomplish in applications with high inertia loads.

FP7 positioning units can handle complex motion control tasks, e.g.

- Position and speed control
- Electronic cam control
- Axis synchronization operations (gear and clutch functions)
- Linear, circular and spiral interpolation (2/3 axes)



Electronic cam control

Electronic cam control allows fast and precise movements and increases the productivity and dynamics in all non-linear movements. Using a configurator software, it is possible to create advanced motion profiles quickly and easily. The tool offers the possibility to insert electronic cam profiles for master and slave axes. Up to 16 cam profiles per slave axis and 20 different sections per master axis can be managed. The master axis can be either a physical or a virtual axis as well as an external encoder.

You can even manage complex movements in processes where you have to work on moving material without interruption, e.g. in wood, textile, plastic or paper applications with flying saws.

Typical applications

- Wrapping and packaging machines
- Bottling machines
- Binding machines
- Pick and place
- Assembly machines
- Molding and sealing machines
- Wood and metal machines
- Textile machines
- Cutting, welding, sawing

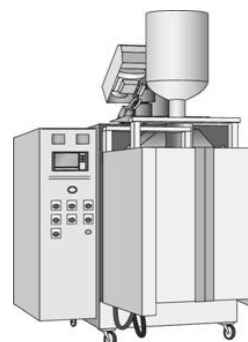
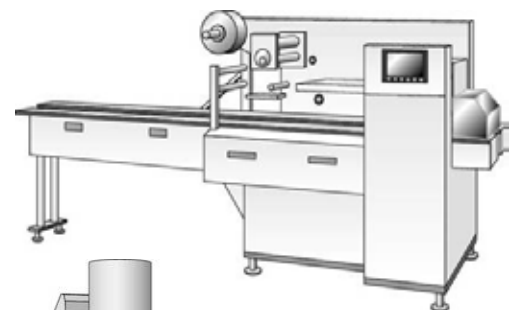

FP7 application examples

Lighting control system

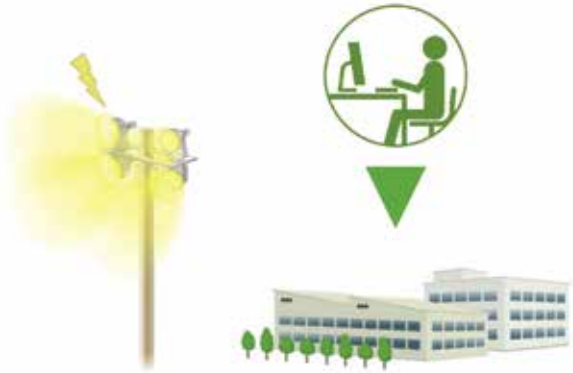

Use the FP7 together with an Eco-POWER METER such as KW2G and a wireless unit to gather data from exterior lighting systems and monitor energy consumption. Data can be logged and visualized remotely on an office PC with the FP Data Analyzer software.

- Remote control of the FP7 with a PC
- Data logging with SD card
- Easy monitoring of the complete lighting system
- Wireless systems reduce installation costs

Visualization of energy consumption in manufacturing plants



Use the FP7 and Web Datalogger unit to monitor the energy consumption of each part in a plant.

- Electricity data can be collected at various locations.
- Multiple Web Datalogger units can be accessed simultaneously
- CPU communication with 16 locations simultaneously via LAN
- Create flexible Excel sheets for energy monitoring with the Data Analyzer
- Measurement data can be stored on SD card

Analog control (high-speed temperature control)

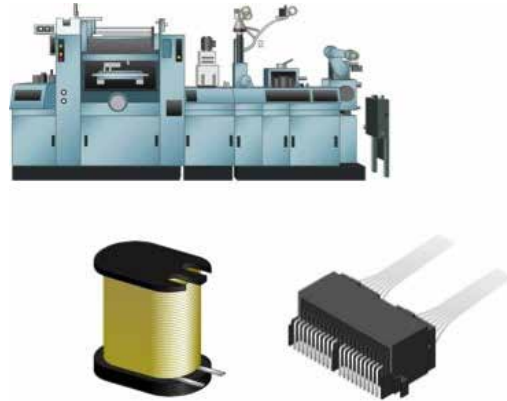

Use an impulse heat controller with high-speed PID control for applications such as thermo-compression bonding, thermal welding, etc.

- Conversion of thermocouple input to achieve high-speed PID control with high precision
- High-speed analog sampling of 25µs/channel
- High precision with linearity of ±0.05% F.S.

Monitoring energy consumption of buildings

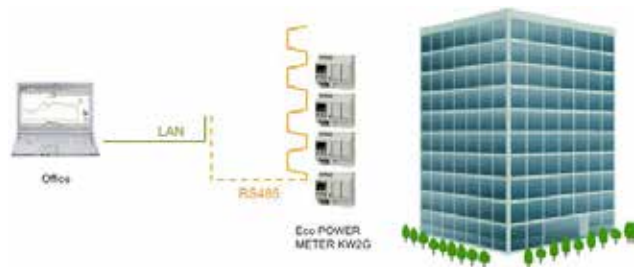

Use the FP7 together with an Eco-POWER METER to monitor the energy consumption of each floor in a building.

- Ability to visualize and monitor the energy consumption (lighting, air conditioning, etc.) of each floor.
- Only one CPU necessary thanks to the FP7's big program capacity and the LAN port available
- Measurement data can be stored on SD card

FP7 CPU types

Compact size with room for expansion functions

- Equipped with a cassette interface.
Add-on cassettes can be added to the CPU to increase functionality without increasing the width of the unit. Communication cassettes support RS232C, RS422 and RS485 serial communications.
- Up to 16 different units can be connected to a single CPU.
- High-capacity SD (SDHC) memory cards of up to 32GB are supported.
- High performance (min. scan time 1ms, max. 20μs for 60k steps); the processing speed is less susceptible to frequent Ethernet communication.
- GT power supply terminals for connecting 5V or 24V DC type GT series programmable displays



Performance specifications

Item	AFP7CPS41E	AFP7CPS31E	AFP7CPS31
Program memory	Built-in flash ROM (no backup battery required)		
Program capacity	196k steps	120k steps	
Operation speed	Basic instruction: min. 11ns/step		
External input (X)/output (Y)	8,192 I/Os, depending on hardware configuration		
Internal relays (R)	32,768		
System relays (SR)	Indicate operation status of various relays		
Link relays (L)	16,384		
Timers (T)	4,096		
Counters (C)	1,024		
Data registers (DT)	256k words		
Link data registers (LD)	16,384 words		
System data registers (SD)	Internal operation status of various registers is shown		
Index registers (IO to IE)	15 double words		
Number of subroutines	Max. 65,535 for each program block (PB)		
Number of interrupt programs	1 periodical interrupt program		
SD memory card function	SDHC memory cards of up to 32GB are usable.		
Constant scan	Available (0 to 125ms)		
Clock/calendar	Year (last two digits), month, day, hour (24-hour build-in display), minute, second and day of week		
Battery backup	For clock/calendar		
Battery life	3.3 years or more (when no power is supplied), actual usage value: 20 years approx. (at 25°C)		
Self-diagnostic function	Watchdog timer and program syntax check		
Comment memory	3MB (no backup battery required)		
PLC Link function	Max. 16 units, link relays: 1,024, link registers: 128 words. (Data transfer and remote programming are not supported)		
Allowed momentary power off time	4ms (at 20.4V), 7ms (at 24V), 10ms (at 28.8V) when directly connected to 24V DC power supply 10ms when AC power supply unit AFP7PSA1/ AFP7PSA2 is used		

Communication specifications

Item	COM port specifications
Interface	RS232C, 1 channel
Transmission distance	15m
Transmission speed	300, 600, 1200, 2400, 4800, 9600, 19200, 38400, 57600, 115200, 230400 bit/s
Communication method	Half duplex
Transmission format	Stop bit: 1 bit/2 bits
	Parity: none/odd/even
	Data length: 7 bits/8 bits
	Start code: with STX/without STX
End code: CR/CR + LF/none/ETX	
Communication mode	Programm controlled communication, MEWTOCOL-COM and MODBUS-RTU

Item	LAN port specifications without AFP7CPS31
Communication interface	Ethernet 100BASE-TX/10BASE-TX
Baud rate	100Mbit/s, 10Mbit/s auto negotiation function
Total cable length	100m (500m when a repeater is used)
Number of nodes	Max. 254 units
Number of simultaneous connections	Max. 20 connections (user connections: 16, system connections: 4)
Protocol	TCP/IP, UDP
DNS	Supports name servers
DHCP/DHCPV6	Automatic IP address acquisition
FTP server	File transfer, server function, number of users: 3
SNTP	Time synchronization

Item	USB port specifications
Standard	USB 2.0 full speed 12Mbit/s (USB miniB type)
Communication mode	MEWTOCOL-COM (Slave)



FP7 communication cassettes

For communication with programmable displays or PCs and for data exchange between PLCs

- Serial communication functions can be added to the CPU. 6 types are available including RS232C dedicated cassettes, cassettes to support either RS422/RS485 or Ethernet, and cassettes that support any combination of RS232C and RS485.
- Protocol supports MODBUS-RTU. Communication can easily be accomplished using comfortable communication instructions.

Communication cassettes

Specifications	Product number
RS232C, 1 channel (insulated)	AFP7CCS1
RS232C, 2 channels (insulated)	AFP7CCS2
RS422 or RS485, 1 channel (insulated)	AFP7CCM1
RS422 or RS485, 2 channels (insulated)	AFP7CCM2
RS232C, 1 channel (insulated) and RS485, 1 channel (insulated)	AFP7CCS1M1
Ethernet 100Base-TX/10Base-T	AFP7CCET1



FP7 application cassettes

For analog and temperature input

- Analog I/O and temperature input functions can be added to the CPU unit. Low cost expansion of the CPU unit with an analog function is easy and installation space can be reduced.
- Low cost addition of functions
Reduced cost and space are realized compared to the analog input and output unit.

Application cassettes

Specifications	Product number
2 channels, analog input 0–10V/0–5V/0–20mA, resolution 12 bit, conversion speed 1ms/channel (non-insulated)	AFP7FCAD2
2 channels, analog input 0–5V/0–10V/0–20mA, resolution 12 bit, conversion speed 1ms/channel (non-insulated); 1-channel analog output 0–10V/0–20mA	AFP7FCA21
2 channels, thermocouple input, K/J type, resolution 0.1°C, conversion speed 100ms/2 channels (insulated)	AFP7FCTC2

FP7 analog input and output units

Channel insulation is switchable to support various devices

- 20 times faster conversion than in previous model
A conversion rate of 25µs/channel is possible, 20 times faster than the previous model's 500µs/channel conversion speed. The system's production efficiency can be improved due to precise control. Highspeed sampling can be achieved, independent of the PLC's scan time.
- High-accuracy control
High-accuracy of ±0.05% (at 25°C) of full scale can be achieved. The high-resolution performance allows users to achieve reliable control.
- Noise-resistant with isolated channels
Channel insulation can be activated to guard against interference from other channels. No need to worry about the power supply system of the objects being measured.
- Multi-channel type (8 channels) available with high-speed processing



Specifications	Product number
4 channels, analog output, voltage/current, conversion speed 25µs/channel, resolution max. 16 bit, accuracy max. ±0.05% F.S. (at 25°C), insulation between channels	AFP7DA4H
4 channels, analog input, voltage/current, conversion speed 25µs/channel, resolution max. 16 bit, accuracy max. ±0.05% F.S. (at 25°C), insulation between channels	AFP7AD4H
8 channels, analog input, voltage/current, conversion speed 25µs/channel, resolution max. 16 bit, accuracy max. ±0.1% F.S. (at 25°C)	AFP7AD8

FP7 thermocouple & RTD units

Multiple types of thermocouples and RTD supported

- Ten types of thermocouples (K, J, T, N, R, S, B, E, PLII and WRe5-26) are supported. They can be used in combination with voltage and current inputs.
- Three types of RTDs (Pt100, JPt100 and Pt1000) are supported for each channel.
- Sensor types can be set in the programming software or by a user program.



Specifications	Product number
8 channels, analog input, resolution 0.1°C, K, J, T, N, R, S, B, E, types	AFP7TC8
8 channels, analog input, resolution 0.1°C, Pt100/JPt100/Pt1000	AFP7RTD8

FP7 digital input, output and mixed I/O units

Inputs/outputs can be added as necessary.

- I/O mixed units are available.
A single I/O mixed unit has 32 input points and 32 output points. The necessary I/O points can be efficiently obtained, resulting in a compact PLC at reduced cost. Dedicated input or output units are also available.
- Transistor output units are designed for a 300mA current capacity.
The 64-point transistor output unit is equipped with 8 outputs with a current capacity of 300mA. Large indicator lamps, magnetic contacts, etc. that previously required relay outputs or external relays can be driven directly.
- Input time constants are configurable.
Response speed can be selected from 0.1ms, 0.5ms, 1ms, 5ms, 10ms, 20ms, or 70ms, depending on the output devices to be used.



Input, output and mixed I/O units

Type	Number of points	Connection method	Specifications	Product number
DC input	16	Terminal block	12 to 24 VDC, configurable input time constant	AFP7X16DW
	32	MIL connector	24VDC, configurable input time constant	AFP7X32D2
	64	MIL connector	24VDC, configurable input time constant	AFP7X64D2
Relay output	16	Terminal block	Relay, 2A/output, 5A/common, 16 outputs/common	AFP7Y16R
Transistor output, sink (NPN)	16	Terminal block	Load current 1.0A, 5A/common, 16 outputs/common	AFP7Y16T
	32	MIL connector	Load current 0.3A, 3.2A/common, 32 outputs/common	AFP7Y32T
	64	MIL connector	Load current 0.3A/0.1A, 3.2A/common, 32 outputs/common	AFP7Y64T
Transistor output, source (PNP)	16	Terminal block	Load current 1.0A, 5A/common, 16 outputs/common	AFP7Y16P
	32	MIL connector	Load current 0.3A, 3.2A/common, 32 outputs/common	AFP7Y32P
	64	MIL connector	Load current 0.3A/0.1A, 3.2A/common, 32 outputs/common	AFP7Y64P
DC input, transistor output, sink (NPN)	Input: 32, output: 32	MIL connector	Input: 24VDC, 32 inputs/common Output: load current 0.3A/0.1A, 3.2A/common, 32 outputs/common	AFP7XY-64D2T
DC input, transistor output, source (PNP)	Input: 32, output: 32	MIL connector	Input: 24VDC, 32 inputs/common Output: load current 0.3A/0.1A, 3.2A/common, 32 outputs/common	AFP7XY-64D2P

FP7 positioning units

High-accuracy positioning control can be achieved at reduced cost.

- Equipped with electronic cam and electronic gear functions
Virtual axes are supported and operable without connecting to external encoders.
- Organized wiring to servo amplifier
A servo ON output terminal is provided that allows simple and neat wiring to the servo amplifier.
- Dedicated configuration tool
Parameter and positioning operation settings can be made easily. Test operation is also supported. Positioning operations can be checked even while the CPU is in program mode.



Specifications				Product number
Output type	No. of axes controlled	Max. operation speed	Functions	
Transistor	2	1–500kpps	Electronic gear and cam function, linear interpolation, circular interpolation	AFP7PP02T
	4			AFP7PP04T
Line driver	2	1–4Mpps		AFP7PP02L
	4			AFP7PP04L

FP7 pulse output units

Super high-speed positioning control can be achieved

- The pulse output request is received from the CPU and the startup time for pulse output is the industry's fastest at 1 μ s. Tact time is reduced with repeated short-distance positioning operations.
- Neater wiring to servo and amplifier
Equipped with a servo ON output terminal, wiring to the servoamplifier is neater.
- Migration from FP2 series is easy
The handling corresponds to the previous FP2 positioning unit (multi-function type). Program transfer is easy.



Specifications				Product number
Output type	No. of axes controlled	Max. operation speed	Functions	
Transistor	2 (independent)	1–500kpps	Linear acceleration, S-shaped acceleration and deceleration control	AFP7PG02T
	4 (independent)			AFP7PG04T
Line driver	2 (independent)	1–4Mpps		AFP7PG02L
	4 (independent)			AFP7PG04L

FP7 high-speed counter units

One of the fastest of its kind has been added to the lineup.

- Industry-leading in its class with 16Mpps (for two-phase factor 4 input mode)
Accurate, real-time surveillance of inverter and motor rotation speed variation.
- Supports 5/12/24VDC and differential input.
Supports a wide range of input signals from 12 to 24VDC, 5VDC and differential input with one unit.
- Powerful application support
Input pulse frequencies are automatically measured in the unit, and a built-in ring counter can easily detect index table positions. An integrated clock allows accurate line speed adjustments and work length measurements.



No. of channels	Specifications	Product number
2 channels	16MHz (for two-phase factor 4 input mode)	AFP7HSC2T
4 channels	4MHz (for incremental/decremental input mode)	AFP7HSC4T

FP7 serial communication unit

Attach one or two communication cassettes to this communication unit.

- A total of five types of cassettes can be freely combined supporting RS232C, RS422, or RS485 and up to 4 channels.
- High expandability
Up to eight serial communication units can be attached to the CPU, offering a max. of 35 communication channels.



Specifications	Product number
For 2 serial communication cassettes, max. 8 units can be installed per CPU	AFP7NSC

FP7 expansion units

High expandability thanks to bus expansion and distributed installation

- Expansion with up to 3 expansion slave blocks is possible.
- Therefore a maximum of 64 I/O units and intelligent units can be connected.
- Distributed installation with high-speed bus transmission

Specifications	Product number
Expansion master unit, up to 3 expansion slave units can be connected to one expansion master unit	AFP7EXPM
Expansion slave unit, up to 16 I/O units and intelligent units can be connected to one expansion slave unit	AFP7EXPS



FP7 power supply units

Announce system errors using the built-in external alarm.

- Output contact for system error external alarm is provided.

	Specifications	
Product number	AFP7PSA1	AFP7PSA2
Rated input voltage	100 to 240V AC	
Allowable input voltage range	85 to 264V AC	
Input power supply frequency	47 to 63Hz	
Inrush current	40A or less	
Input current	0.75A or less	1.25A or less
Rated output current (at 24 V)	1.0A	1.8A
Alarm contact capacity	1A (30V DC)	
Remaining lifespan counter	Not available	Available



FP-PS24 power supplies

24V DC power supplies

- Up to 91.5% efficiency (FP-PS24-060E)
- Current limiting and short circuit protection
- High power density with minimal losses
- Wide ambient temperature range from -10°C to +70°C, without performance loss



	Specifications		
Product number	FP-PS24-120E	FP-PS24-060E	FP-PS24-024E
Specification	Primary side 100-240VAC, secondary side 24V DC/5A	Primary side 100-240VAC, secondary side 24V DC/2.5 A	Primary side 100-240VAC, secondary side 24V DC/1A
Allowable input voltage range	<ul style="list-style-type: none"> • Safety approvals (IEC 60950, UL 60950, CSA22.2-60950, EN 60950) tested by CSA • Protection class II, without grounding • Compact size with optimal cooling • Easy DIN-rail mounting and wiring 		

Fieldbus master units

Powerful, compact, modular, and with high performance

- Used together with the programmable controllers of the FP7 series
- Available for PROFIBUS, DeviceNet, CANopen and Profinet IO

Unit type	Product number
FP7 CANopen master units	AFP7NCANM
FP7 DeviceNet master units	AFP7NDNM
FP7 PROFIBUS master units	AFP7NPFBM
FP7 Profinet IO master units	AFP7NPFNM



Control FPWIN Pro

Control FPWIN Pro is the Panasonic programming software developed according to the international standard IEC 61131-3 (for Windows® XP/Vista/7/8). Control FPWIN Pro is the universal software for all Panasonic PLCs.

- Programs written in Control FPWIN Pro 6 or earlier versions will run with Control FPWIN Pro 7
- Programs are compatible across FP series PLCs, e.g. FP0R will run with minor adjustments on FPΣ (Sigma) and FP7 PLCs
- FP7 PLCs and Control FPWIN Pro 7 offer the same flexible choice of editors and allow you to select the programming language you are most familiar with.

Navigators provide an overview, even for very complex projects

Toolbar contains icons for frequently used menus

Structured Text (ST) programming editor

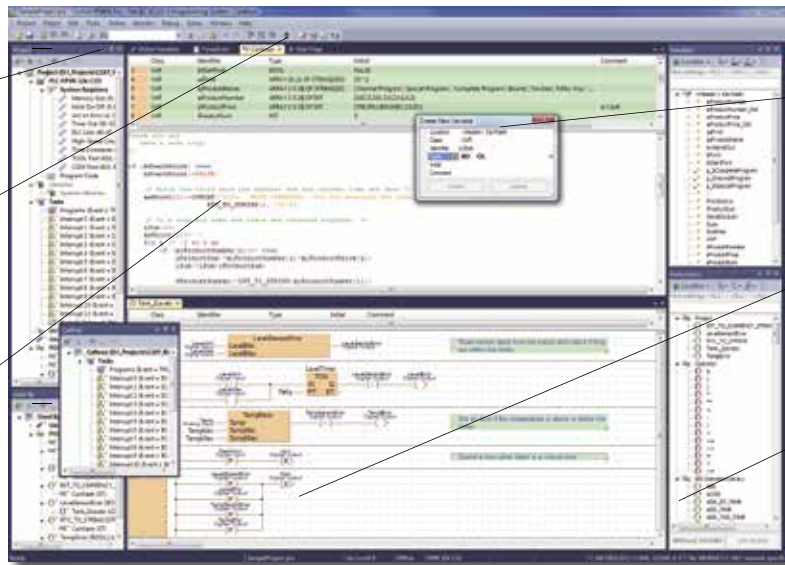

Declaration of variables

Ladder Diagram (LD) programming editor

Selection of instructions

Control FPWIN Pro highlights

- One software for all FP-series PLCs
- 5 programming languages: IL (Instruction List), LD (Ladder Diagram), FBD (Function Block Diagram), SFC (Sequential Function Chart), ST (Structured Text)
- 8 languages are fully supported: English, German, French, Italian, Spanish, Japanese, Korean, Chinese
- Well-structured through program organization units, task and project management
- Remote programming, service and diagnostics via modem or Ethernet
- Extensive comments and online documentation created hand in hand with the program
- Min. program size through optimized compiler
- Powerful debugging and monitoring tools provide information on the current status of the PLC.
- Comprehensive printed documentation and support for function blocks and libraries help to get your hardware running in record time while maintaining rigorous quality standards.
- Reuse of functions and function blocks saves time.

Control FPWIN Pro and its comprehensive, powerful libraries

The PLC programming software Control FPWIN Pro has been evolving for over 15 years, and along with it its libraries. As expected, the latest version of the software includes even more commands to help you efficiently program your PLC.

The innovations of this version include several new program features, some of which have been implemented for the FP7:

- Real-time clock on the PLC configurable in the software
- Support of all IEC functionalities like POU's, editors, data types and instructions
- New family of overloaded and type-safe instructions usable for 32-bit type PLCs (FP7) and 16-bit type PLCs
- SD card instructions

Additional function blocks for simplifying work with analog values, e.g.:

- Scaling
- Averaging
- Assigning addresses for expansion units

Together with the FP7, the new functions have simplified data handling even more. Data can be transmitted via Ethernet communication or stored on SD cards. Special logging and trace instructions help with data and process monitoring.



Powerful libraries, programmed by experts

The **Control FPWIN Pro Web-Server library** allows you to take advantages of the FP Web-Server functions quickly and easily, e.g. sending an e-mail, controlling an FTP client, establishing a PPP connection, or synchronizing the clock with NTP.

The **Control FPWIN Pro Motion Control library** shortens the time required for commissioning, resets the motion controller, motor or an external encoder in regards to the PLC and, thanks to a high output frequency range, enables exact positioning and movement.

Product numbers

FP7 CPUs

Description	Product number
120k steps, operation speed 11ns, no Ethernet support	AFP7CPS31
120k steps, operation speed 11ns, Ethernet communication available	AFP7CPS31E
196k steps, operation speed 11ns, Ethernet communication available	AFP7CPS41E

FP7 communication cassettes

Description	Product number
RS232C, 1 channel (insulated)	AFP7CCS1
RS232C, 2 channels (insulated)	AFP7CCS2
RS422 or RS485, 1 channel (insulated)	AFP7CCM1
RS422 or RS485, 2 channels (insulated)	AFP7CCM2
RS232C, 1 channel (insulated) and RS485	AFP7CCS1M1
Ethernet 100Base-TX/10Base-T	AFP7CCET1

FP7 application cassettes

Description	Product number
2-channel analog input voltage/current	AFP7FCAD2
2-channel analog input, 1-channel analog	AFP7FCA21
2-channel thermocouple input, K/J type	AFP7FCTC2

FP7 digital input, output and mixed I/O units

Description	Product number
16 IN, 12–24V DC, configurable input time constant	AFP7X16DW
32 IN, 12–24V DC, configurable input time constant	AFP7X32D2
64 IN, 12–24V DC, configurable input time constant	AFP7X64D2
16 OUT, relay, 2A/point, 5A/common, 16 outputs/common	AFP7Y16R
16 OUT, transistor, PNP, load current 1.0A, 5A/common, 16 outputs/common	AFP7Y16P
16 OUT, NPN, load current: 1.0A, 5A/common, 16 outputs/common	AFP7Y16T
32 OUT, transistor, PNP, load current 0.3A, 3.2A/common, 32 outputs/common	AFP7Y32P
32 OUT, NPN, load current 0.3A, 3.2A/common, 32 outputs/common	AFP7Y32T
64 OUT, transistor, PNP, load current 0.3A/0.1A, 3.2A/common, 32 outputs/common	AFP7Y64P
64 OUT, load current: 0.3A, 0.1A, mixed 3.2A/common, 32 outputs/common	AFP7Y64T
32 IN, 32 OUT, transistor, PNP, input: 24V DC, 32 inputs/common Output: load current 0.3A/0.1A, 3.2A/common, 32 outputs/common	AFP7XY64D2P
32 IN, 32 OUT, NPN, input: 24V DC, 32 inputs/common Output: load current: 0.3A, 0.1A, mixed 3.2A/common, 32 outputs/common	AFP7XY64D2T

FP7 analog input and output units

Description	Product number
Output unit, 4 channels, voltage/current, conversion rate: 25µs/channel, resolution max. 16 bit, accuracy: max. ±0.05% F.S. (at 25°C)	AFP7DA4H
Input unit, 4 channels, voltage/current, conversion rate: 25µs/channel, resolution max. 16 bit, accuracy: max. ±0.05% F.S. (at 25°C)	AFP7AD4H
Input unit, 8 channels, voltage/current, conversion rate: 25µs/channel, resolution max. 16 bit, accuracy: max. ±0.1% F.S. (at 25°C)	AFP7AD8

FP7 serial communication unit

Description	Product number
2 cassettes per unit, max. 8 units can be installed per CPU	AFP7NSC

FP7 thermocouple and RTD I/O units

Description	Product number
8 input channels, resolution 0.1°C, K, J, T, N, R, S, B, E, types	AFP7TC8
8 input channels, resolution 0.1°C, Pt100/JPt100/Pt1000	AFP7RTD8

FP7 high-speed counter units

Description	Product number
2 channels, 16MHz (for two-phase factor 4 input mode), 4MHz (for incremental/decremental input mode)	AFP7HSC2T
4 channels, 16MHz (for two-phase factor 4 input mode), 4MHz (for incremental/decremental input mode)	AFP7HSC4T

FP7 positioning units

Description	Product number
Line driver, 2 axes, 1–4Mpps, electronic gear and cam function, linear interpolation, circular interpolation	AFP7PP02L
Line driver, 4 axes, 1–4Mpps, electronic gear and cam function, linear interpolation, circular interpolation	AFP7PP04L
Transistor, 2 axes, 1–500kpps, electronic gear and cam function, linear interpolation, circular interpolation	AFP7PP02T
Transistor, 4 axes, 1–500kpps, electronic gear and cam function, linear interpolation, circular interpolation	AFP7PP04T

FP7 pulse output units

Description	Product number
Line Driver, 2 axis, 1pps to 500kpps	AFP7PG02L
Line Driver, 4 axis, 1pps to 500kpps	AFP7PG04L
Transistor, 2 axis, 1pps to 4Mpps	AFP7PG02T
Transistor, 4 axis, 1pps to 4Mpps	AFP7PG04T

FP7 expansion units

Description	Product number
Expansion master unit	AFP7EXPM
Expansion slave unit	AFP7EXPS

FP7 power supply units

Description	Product number
Power supply unit, input 100–240VAC, output 24VDC 1.0A	AFP7PSA1
Power supply unit, input 100–240VAC, output 24VDC 1.8A	AFP7PSA2
Power supply unit 24W (primary 100 to 240VAC, 2 x secondary 24V DC/1A, short circuit protected)	FP-PS24-024E
Power supply unit 60W (primary 100 to 240VAC, 2 x secondary 24V DC/2.5A, short circuit protected)	FP-PS24-060E
Power supply unit 120W (primary 100 to 240VAC, 2 x secondary 24V DC/5A, short circuit protected)	FP-PS24-120E

Control FPWIN Pro

Description	Product number
Control FPWIN Pro programming software, version 7, version for all FP series PLCs	FPWINPRO7S
Control FPWIN PRO upgrade to version 7	FPWINPRO7S-UP
Programming cable (FP0R/FP0/FP-e/FPG/FPX/FP2 TOOL port to PC) miniDIN5 to 9-pin Sub-D; 2m	AFC8513D
Cable with USB 1.1 to RS232C with 9-pin Sub-D converter; 2m	CABUSBSER9D
Programming cable: USB A to USB B, 2m	AFPXCABUSB2D
Programming cable for FP7, USB A to mini USB B (5pin), 2m, USB2.0 compatible	CABMINIUSB5D

Further Panasonic products

Panasonic Electric Works offers a wide product range from one source, from individual components to complete systems. Technology support for advice, design-in, installation and commissioning by our qualified application engineers round off the Panasonic service profil.



Human Machine Interfaces

Our compact size, bright and easy-to-read Human Machine Interfaces can be used to visualize inspection results. Touch panels can even replace the standard keypad if you so desire.



Servo drives

Panasonic servo drives enable high performance motion control to be applied to almost all types of machines, including chip mounting machines and general industrial machines.



UV curing systems

Aicure UJ30 is a LED curing system that quickly hardens UV-sensitive resins such as adhesives, ink and coatings. Its cutting edge LED technology is especially suited for precise, high-intensity curing.



ACD components

Components such as Eco-POWER-METERS, timers/counters, temperature controllers, limit switches and fans round off our wide factory automation product range.

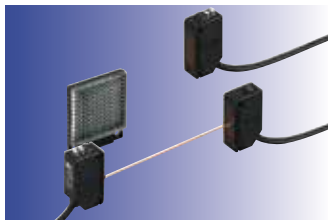

Sensors

As a pioneering manufacturer of sensors, Panasonic provides high performance sensors for a wide range of applications, facilitating factory automation in various types of production lines, such as those used for the manufacturing of semiconductors.



Laser Markers

Panasonic Laser Markers are ideal for non-contact, permanent labelling of most materials, e.g. plastics, glass, paper, wood and leather. Several CO₂ laser marking systems and a unique FAYb Laser Marker can be easily integrated into existing production systems for a great variety of labelling tasks.

North America

Europe

Asia Pacific

China

Japan

Panasonic Electric Works

Please contact our Global Sales Companies in:

Europe

▶ Headquarters	Panasonic Electric Works Europe AG	Rudolf-Diesel-Ring 2, 83607 Holzkirchen, Tel. +49 (0) 8024 648-0, Fax +49 (0) 8024 648-111, www.panasonic-electric-works.com
▶ Austria	Panasonic Electric Works Austria GmbH	Josef Madersperger Str. 2, 2362 Biedermannsdorf, Tel. +43 (0) 2236-26846, Fax +43 (0) 2236-46133 www.panasonic-electric-works.at
	Panasonic Industrial Devices Materials Europe GmbH	Ennschafenstraße 30, 4470 Enns, Tel. +43 (0) 7223 883, Fax +43 (0) 7223 88333, www.panasonic-electronic-materials.com
▶ Benelux	Panasonic Electric Works Sales Western Europe B.V.	De Rijn 4, (Postbus 211), 5684 PJ Best, (5680 AE Best), Netherlands, Tel. +31 (0) 499 372727, Fax +31 (0) 499 372185, www.panasonic-electric-works.nl
▶ Czech Republic	Panasonic Electric Works Europe AG	Administrative centre PLATINIUM, Veveří 3163/111, 616 00 Brno, Tel. +420 541 217 001, Fax +420 541 217 101, www.panasonic-electric-works.cz
▶ France	Panasonic Electric Works Sales Western Europe B.V.	Succursale française, 10, rue des petits ruisseaux, 91370 Verrières Le Buisson, Tél. +33 (0) 1 6013 5757, Fax +33 (0) 1 6013 5758, www.panasonic-electric-works.fr
▶ Germany	Panasonic Electric Works Europe AG	Rudolf-Diesel-Ring 2, 83607 Holzkirchen, Tel. +49 (0) 8024 648-0, Fax +49 (0) 8024 648-111, www.panasonic-electric-works.de
▶ Hungary	Panasonic Electric Works Europe AG	Magyarországi Közvetlen Kereskedelmi Képviselet, 1117 Budapest, Neumann János u. 1., Tel. +36 1 999 89 26 www.panasonic-electric-works.hu
▶ Ireland	Panasonic Electric Works UK Ltd.	Irish Branch Office, Dublin, Tel. +353 (0) 14600969, Fax +353 (0) 14601131, www.panasonic-electric-works.co.uk
▶ Italy	Panasonic Electric Works Italia srl	Via del Commercio 3-5 (Z.I. Ferlina), 37012 Bussolengo (VR), Tel. +39 0456752711, Fax +39 0456700444, www.panasonic-electric-works.it
▶ Nordic Countries	Panasonic Electric Works Europe AG Panasonic Eco Solutions Nordic AB	Filial Nordic, Knarrarnäsgatan 15, 164 40 Kista, Sweden, Tel. +46 859476680, Fax +46 859476690, www.panasonic-electric-works.se
▶ Poland	Panasonic Electric Works Polska sp. z o.o	Jungmansgatan 12, 21119 Malmö, Tel. +46 40 697 7000, Fax +46 40 697 7099, www.panasonic-fire-security.com
▶ Spain	Panasonic Electric Works España S.A.	ul. Wołoska 9A, 02-583 Warszawa, Tel. +48 22 338-11-33, Fax +48 22 338-12-00, www.panasonic-electric-works.pl
▶ Switzerland	Panasonic Electric Works Schweiz AG	Barajas Park, San Severo 20, 28042 Madrid, Tel. +34 913293875, Fax +34 913292976, www.panasonic-electric-works.es
▶ United Kingdom	Panasonic Electric Works UK Ltd.	Grundstrasse 8, 6343 Rotkreuz, Tel. +41 (0) 41 7997050, Fax +41 (0) 41 7997055, www.panasonic-electric-works.ch
		Sunrise Parkway, Linford Wood, Milton Keynes, MK14 6LF, Tel. +44 (0) 1908 231555, Fax +44 (0) 1908 231599, www.panasonic-electric-works.co.uk

North & South America

▶ USA	Panasonic Industrial Devices Sales Company of America	629 Central Avenue, New Providence, N.J. 07974, Tel. 1-908-464-3550, Fax 1-908-464-8513, www.pewa.panasonic.com
--------------	--	---

Asia Pacific/China/Japan

▶ China	Panasonic Electric Works Sales (China) Co. Ltd.	Level 2, Tower W3, The Towers Oriental Plaza, No. 2, East Chang An Ave., Dong Cheng District, Beijing 100738, Tel. +86-10-5925-5988, Fax +86-10-5925-5973
▶ Hong Kong	Panasonic Industrial Devices Automation Controls Sales (Hong Kong) Co., Ltd.	RM1205-9, 12/F, Tower 2, The Gateway, 25 Canton Road, Tsimshatsui, Kowloon, Hong Kong, Tel. +852-2956-3118, Fax +852-2956-0398
▶ Japan	Panasonic Corporation	1048 Kadoma, Kadoma-shi, Osaka 571-8686, Japan, Tel. +81-6-6908-1050, Fax +81-6-6908-5781, www.panasonic.net
▶ Singapore	Panasonic Industrial Devices Automation Controls Sales Asia Pacific	300 Beach Road, #16-01 The Concourse, Singapore 199555, Tel. +65-6390-3811, Fax +65-6390-3810