INVT Control Product Catalog

Programmable Controller / Human Machine Interface / Industrial Internet



Company profile

Shenzhen INVT Electric Co., Ltd. (INVT for short, stock code: 002334) was founded in 2002, focusing on the fields of industrial automation and energy power. It was listed on Shenzhen Stock Exchange (SZSE) and issued A shares in 2010. Adhering to the core values of "Achieve customers, performance orientation, open and win-win cooperation, struggle and innovation" and with the mission of making every effort to offer most valuable products and services to strengthen customer competitiveness, INVT provides differentiated and specialized industry solutions, customized technical services, global localization operations, and digital management models to global customers.

Core competitiveness

Company scale: INVT has 4 large bases of production and research, 15 holding subsidiaries, and over 5000 employees.

R&D capability: INVT is a national key high-tech enterprise in China's Torch Program and a drafting unit for the national standard of low-voltage VFDs. It has established a strict quality management system and passed CNAS certification. The R&D testing laboratory has been awarded the Acceptance of Client Testing (ACT) accreditation by TUV-SUD in Germany, and the main products are CE-compliant. INVT has also been recognized as the National Enterprise Technology Center, and Guangdong Engineering Technology Research Center, and has undertaken a number of national, provincial and municipal science and technology projects. By the end of 2023, INVT has 1538 patents and 283 computer software copyrights.

Marketing and service network: INVT has set up dozens of branches and hundreds of joint warranty centers around the world, and has established strong cooperative relationships with many domestic and international channel partners. This comprehensive sales and service network enables INVT to respond quickly to global market demands and provide immediate technical support and quality after-sales service.

Business segments

Industrial automation: Offering VFDs, servo systems, motors, controllers, human-machine interfaces, sensors, elevator drive systems, industrial internet, and other products and integrated solutions, which are widely used in compressors, cranes, solar pumps, printing and packaging machinery, 3C electronics, lithium-ion battery equipment, semiconductor equipment, offshore equipment, iron and steel, petroleum, chemical industry, and other fields.

Network power: Offering micro module data centers, power supply and distribution products, intelligent temperature control products, intelligent monitoring products, and integrated solutions, which are widely used in cloud data centers, finance, communication, medical, energy, and other fields.

New energy vehicle: Offering comprehensive products such as main motor controllers, auxiliary motor controllers, vehicle controllers, and onboard power supplies, covering the full range of solutions for commercial vehicles and passenger cars.

PV energy storage: Offering grid-tie inverters, energy storage inverters, off-grid inverters, monitoring accessories, which have been applied in many scenarios at home and abroad.

CONTENT



P3

Small PLC

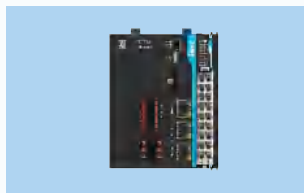

P27

Medium PLC



P37

X86 Controller



P43

I/O system



P65

HMI



P73

Industrial internet

INVT Automation networking

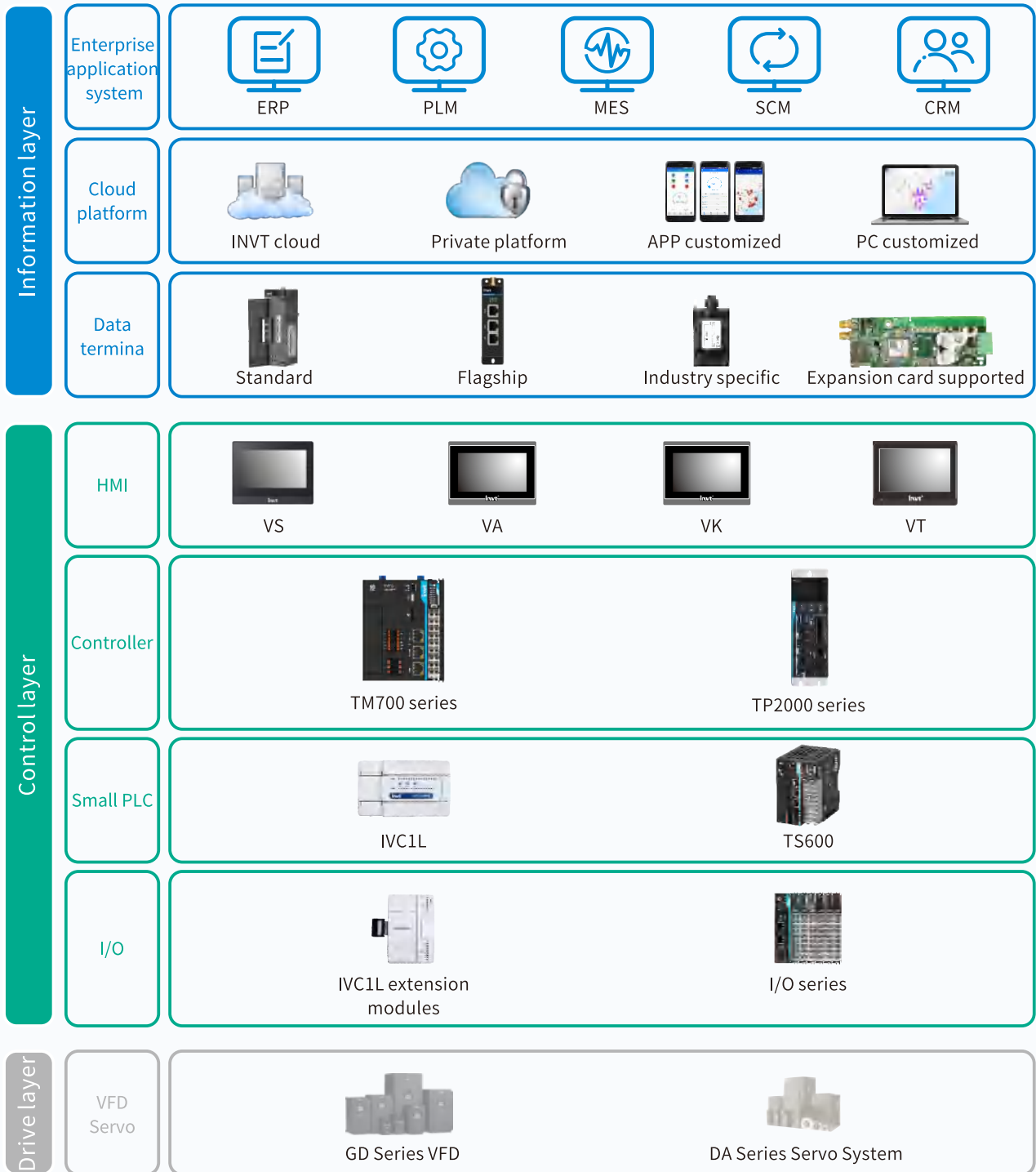

Small PLC

IVC series PLC features fast speed, stable performance, strong function and software usability.



IVC1L feature

IVC1L is a general-purpose PLC product with compact structure, complete functions, and flexible I/O configuration. It can be widely used in small-scale IO and simple positioning applications.

- 60 built-in I/O points, able to add on 7 modules and 128 I/O points
- 16K steps program capacity
- 1 RS232, 2 RS485, supporting the Modbus master/slave protocol
- Two 50K+four 10K high speed input ports
- Three 100K high speed output (transistor type) ports
- Support real time clock function and built-in battery
- Support DC power supply and AC power supply modules



IVC1L technical specification

Model	IVC1L-	0806MAT	1410MAT	1614MAT	1614MAT1	2416MAT	3624MAT	0806MAR	1410MAR	1614MAR	2416MAR	3624MAR	
Power													
Input	Voltage	220VAC (85~264VAC)											
	Current	1.5A											
Output	5V/GND	900mA											
	24V/GND	300mA											
	24V/COM	600mA											
I/O configuration													
Built-in I/O	Total	14	24	30	30	40	60	14	24	30	40	60	
	Input	8	14	16	16	24	36	8	14	16	24	36	
	Output	6	10	14	14	16	24	6	10	14	16	24	
	Input type	NPN/PNP						NPN/PNP					
	Output type	Transistor (NPN)						Relay					
Extension I/O	Extension module	7											
	Total	128											
Analog		-			2 AI, 1 AO		-						
High speed I/O													
High speed input		2×50KHz+4×10KHz, AB phase (1×30K, 1×5K)						2×50KHz+4×10KHz, AB phase (1×30K, 1×5K)					
High speed output		3×100KHz						-					
Communication													
Serial port	RS232	1											
	RS485	2											
	Protocol	Programming protocol; MODBUS master/slave; free port; N:N protocol											
Storage													
Program capacity		16K steps											
Data block		8000 D registers											
Interrupt													
External input interrupt		16											
High speed counter interrupt		6											
Internal time interrupt		3											
Serial port interrupt		12											
PTO output completion interrupt		3											
Power loss interrupt		1											
Programming													
Software		Auto Station											
Subprogram calling		Supported total 64 subprograms (6 levels), and it can supports the design of input and output interfaces											
Others													
Digital filtering function		X0-X7 adopts digital filtering and other ports adopt hardware filtering											
Encryption		Upload/download password, monitor password, subprogram encryption, format disable, upload disable											
Real time clock		Support, built-in battery											
Data saving function at power failure		Supported											

Model	IVC1L-	0806MDT	1410MDT	1614MDT	2416MDT	3624MDT	0806MDR	1410MDR	1614MDR	2416MDR	3624MDR	1614MAR1	1616MAR6	
Power														
Input	Voltage	24VDC (19~30VDC)										220VAC (85~264VAC)		
	Current	0.85A										15A		
Output	5V/GND	900mA												
	24V/GND	300mA												
	24V/COM	-										600mA		
I/O configuration														
Built-in I/O	Total	14	24	30	40	60	14	24	30	40	60	30	32	
	Input	8	14	16	24	36	8	14	16	24	36	16	16	
	Output	6	10	14	16	24	6	10	14	16	24	14	16	
	Input type	NPN/PNP						NPN/PNP						
	Output type	Transistor (NPN)						Relay						
Extension I/O	Extension module	7												
	Total	128												
Analog	-										2 AI, 1 AO		2 thermal resistance	
High speed I/O														
High speed input	2×50KHz+4×10KHz, AB phase (1×30K, 1×5K)								2×50KHz+4×10KHz, AB phase (1×30K, 1×5K)					
High speed output	3×100KHz								-					
Communication														
Serial port	RS232	1												
	RS485	2												
	Protocol	Programming protocol; MODBUS master/slave; free port; N:N protocol												
Storage														
Program capacity	16K steps													
Data block	8000 D registers													
Interrupt														
External input interrupt	16													
High speed counter interrupt	6													
Internal time interrupt	3													
Serial port interrupt	12													
PTO output completion interrupt	3													
Power loss interrupt	1													
Programming														
Software	Auto Station													
Subprogram calling	Supported total 64 subprograms (6 levels), and it can supports the design of input and output interfaces													
Others														
Digital filtering function	X0~X7 adopts digital filtering and other ports adopt hardware filtering													
Encryption	Upload/download password, monitor password, subprogram encryption, format disable, upload disable													
Real time clock	Support, built-in battery													
Data saving function at power failure	Supported													
IVC1L														
Soft element														
Inputs	X element, 128													
Outputs	Y element, 128													
Auxiliary relays	M element, 2048													
Local auxiliary relays	LM element, 64													
Special auxiliary relays	SM element, 512													
Status relays	S element, 1024													
Data registers	D element, 8000													
Local data registers	V element, 64													
Indexing/addressing registers	Z element, 16													
Special data registers	SD element, 512													
Timer	Total	T element, 256												
	1ms	T252~T255												
	10ms	T210~T251												
	100ms	T0~T209												
Counter	Total	C element, 256												
	16bit up counter	C0~C199												
	32bit up/down counter	C200~C235												
	32bit high speed counter	C236~C255												
Rising edge	1024													
Falling edge	1024													

IVC1L dimension

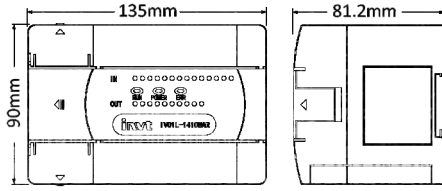

Model	Dimension
IVC1L-0806M** IVC1L-1410M**	135×90×81.2mm

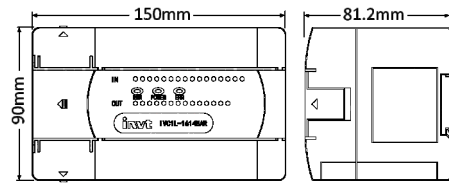

Model	Dimension
IVC1L-1614M**	150×90×81.2mm

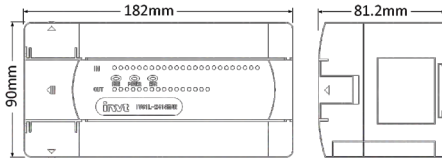

Model	Dimension
IVC1L-1614MAR1 IVC1L-1614MAT1 IVC1L-1616MAR6 IVC1L-2416M**	182×90×81.2mm

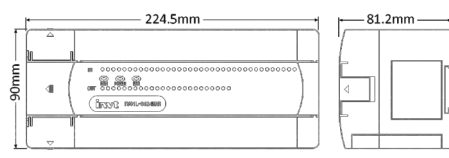

Model	Dimension
IVC1L-3624M**	224.5×90×81.2mm

IVC1L(AC) wiring diagram

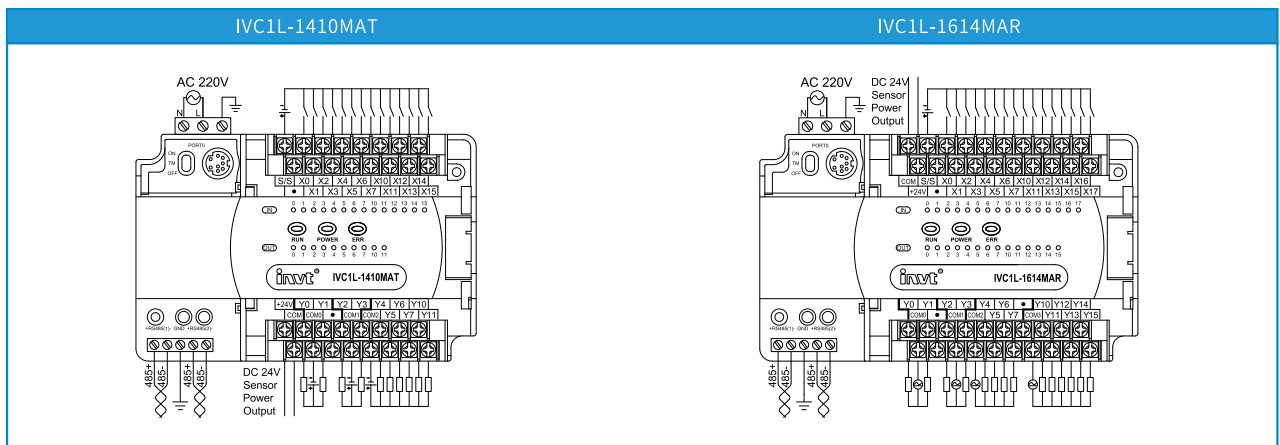
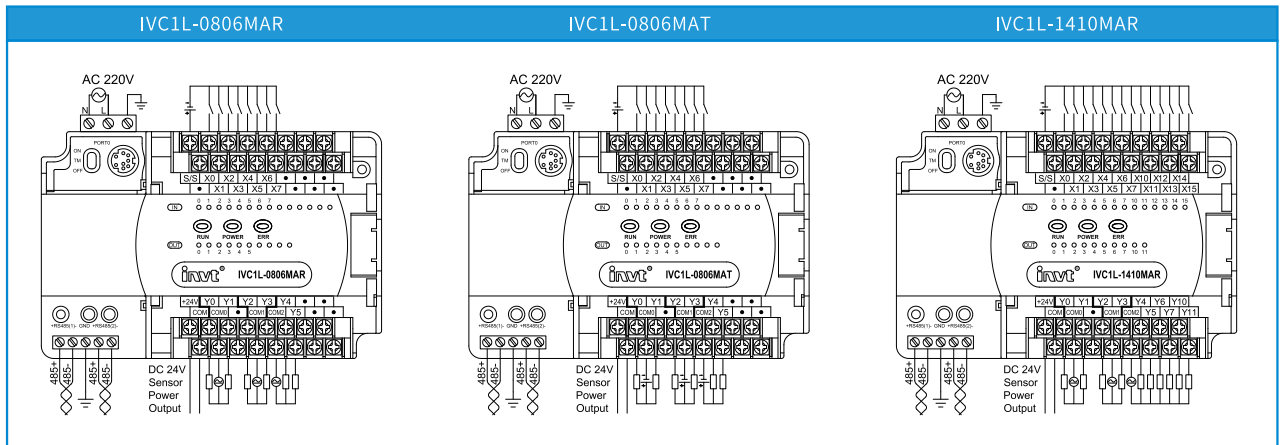

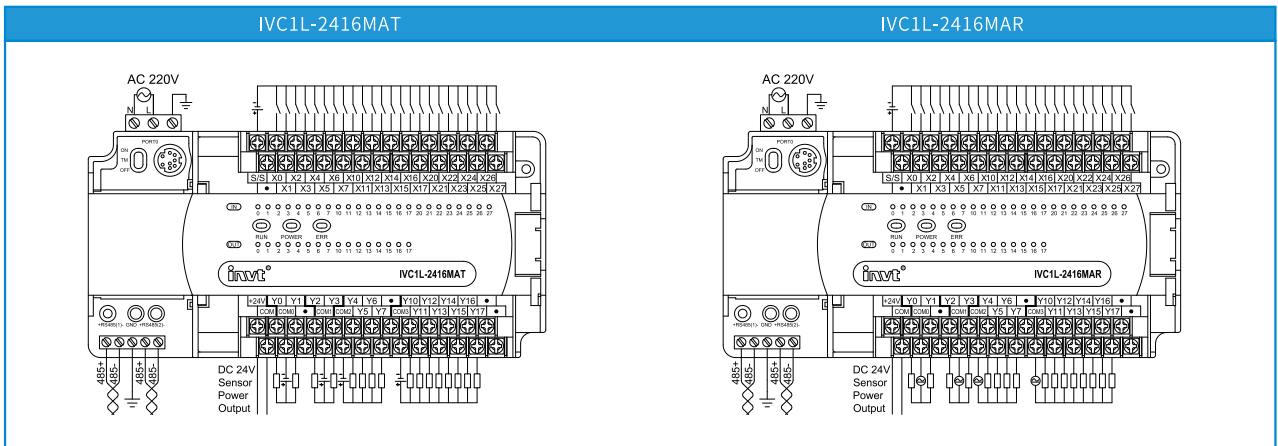
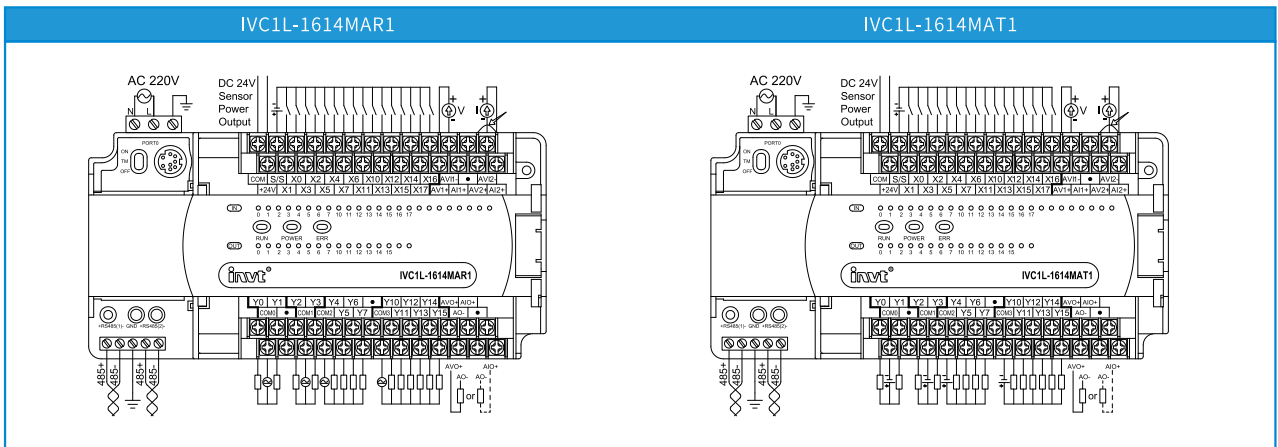
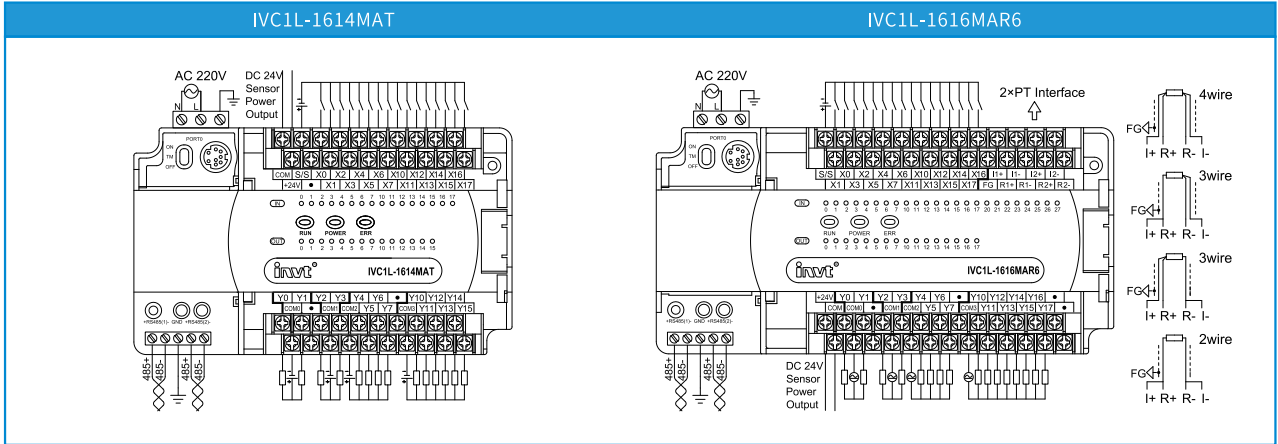

IVC1L-3624MAT

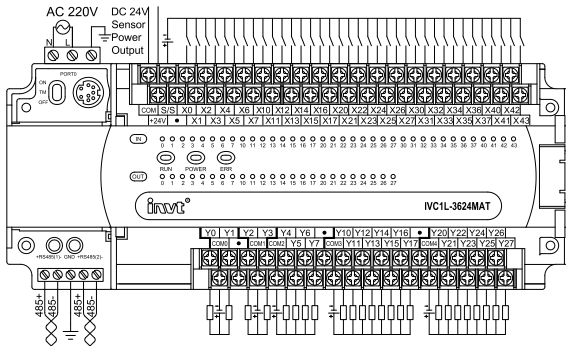

IVC1L-3624MAR

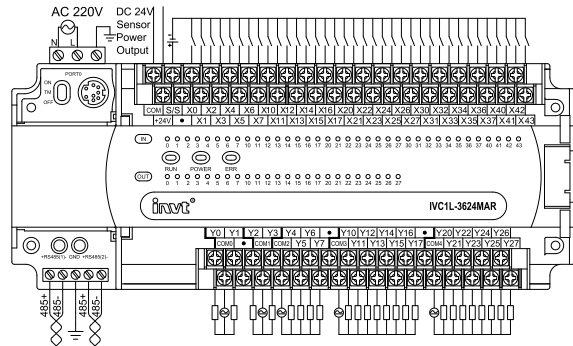

IVC1L(DC) wiring diagram

IVC1L-0806MDR

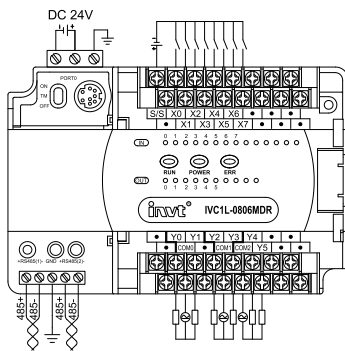

IVC1L-0806MDT

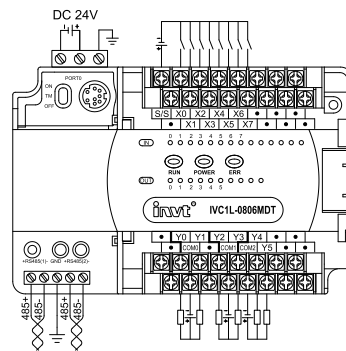

IVC1L-1410MDR

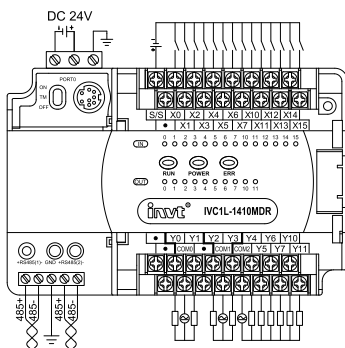

IVC1L-1410MDT

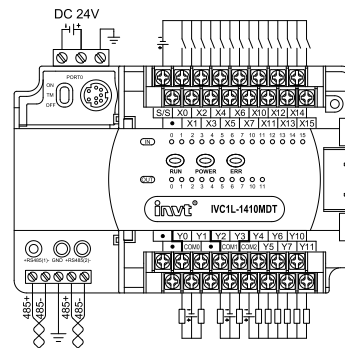

IVC1L-1614MDR

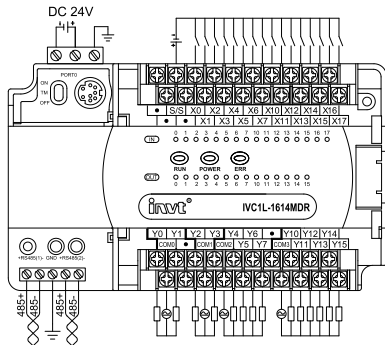

IVC1L-1614MDT

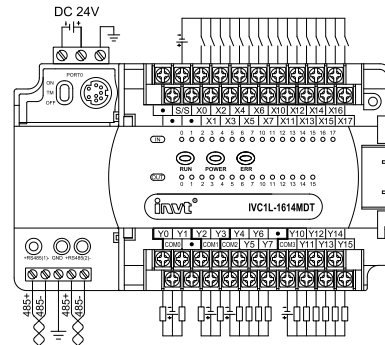

IVC1L-2416MDR

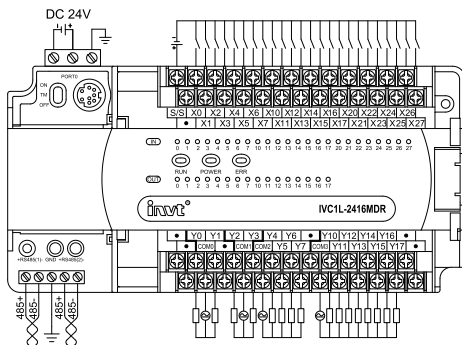

IVC1L-2416MDT

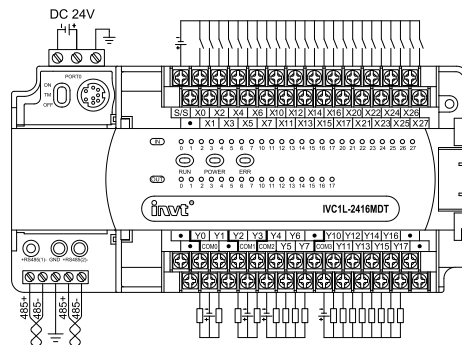

IVC1L-3624MDR

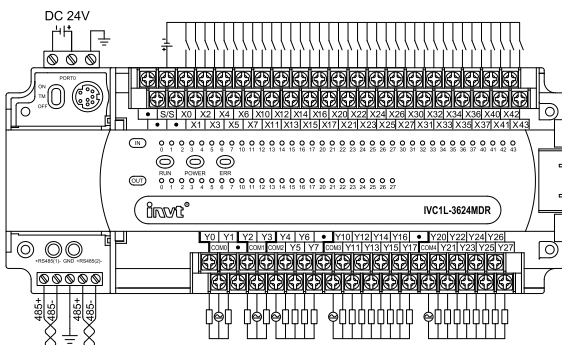

IVC1L-3624MDT

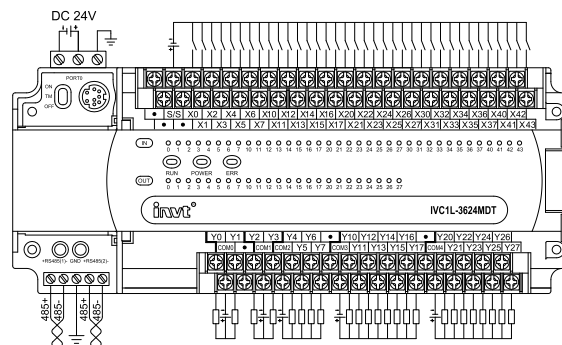

● Digital input module



Model		IVC1L-1600ENN
Product overview		16 digital inputs
General		
Dimension		61×90×81.2mm
Power	5V/GND	70mA
	24V/GND	—
Output specification		
Inputs		16
Input type		PNP/NPN (source type/sink type)
Input voltage		24VDC
Current		60mA (DC24V/COM)
Insulation		Optocoupler insulation
Action indication		LED is on when optocoupler is driven
Equivalent resistance		4.3kΩ/channel
Logic 1 signal		≥15VDC
Logic 0 signal		≤5VDC

● Digital output module



Model		IVC1L-0016ENT
Product overview		16 points transistor output
General		
Dimension		61×90×81.2mm
Power	5V/GND	170mA
	24V/GND	—
Output specification		
Outputs		16
Output type		Transistor
Voltage		24VDC
Insulation		Optocoupler insulation
Action indication		LED is on when optocoupler is driven
Minimum load		5mA (5~24VDC)
Max. output current	Resistive load	Total current can be increased by 0.1A for every additional 1 point above 8 points
	Inductive load	24VDC, 7.2W
	Lamp load	24VDC, 1.5W
Response time	OFF→ON	Max.0.5ms (100mA/24VDC)
	ON→OFF	Max.0.5ms (100mA/24VDC)
Contact life		—



Model		IVC1L-0016ENR
Product overview		16 points relay output
General		
Dimension		61×90×81.2mm
Power	5V/GND	70mA
	24V/GND	100mA
Output specification		
Outputs		16
Output type		Relay
Voltage		250VAC, below 30VDC
Insulation		Mechanical insulation of relay
Action indication		The LED light is on when relay output contact closed
Minimum load		2mA/5VDC
Max. output current	Resistive load	2A/1point, The total current of 8 points of common COM terminal is less than 8A
	Inductive load	220VAC, 80VA
	Lamp load	220VAC, 100W
Response time	OFF→ON	Max.20ms
	ON→OFF	Max.20ms
Contact life		200,000 time

• Digital input/output module



Model		IVC1L-0808ENT
Product overview		8 digital inputs, 8 points transistor output
General		
Dimension		61×90×81.2mm
Power	5V/GND	170mA
	24V/GND	-
Input specification		
Inputs		8
Input type		PNP/NPN (source type/sink type)
Input voltage		24VDC
Current		50mA (DC24V/COM)
Insulation		Optocoupler insulation
Action indication		LED is on when optocoupler is driven
Equivalent resistance		4.3kΩ/channel
Logic 1 signal		≥15VDC
Logic 0 signal		≤5VDC
Output specification		
Outputs		8
Output type		Transistor
Voltage		5-24VDC
Insulation		Optocoupler insulation
Action indication		LED is on when optocoupler is driven
Minimum load		5mA (5-24VDC)
Max. output current	Resistive load	0.3A/1 point 0.8A/4points 1.6A/8points
	Inductive load	24VDC, 7.2W
	Lamp load	24VDC, 1.5W
Response time	OFF→ON	Max.0.5ms (100mA/24VDC)
	ON→OFF	Max.0.5ms (100mA/24VDC)
Contact life		-



Model		IVC1L-0808ENR
Product overview		8 digital inputs,8 points relay output
General		
Dimension		61×90×81.2mm
Power	5V/GND	70mA
	24V/GND	50mA
Input specification		
Inputs		8
Input type		PNP/NPN (source type/sink type)
Input voltage		24VDC
Current		50mA (DC24V/COM)
Insulation		Optocoupler insulation
Action indication		LED is on when optocoupler is driven
Equivalent resistance		4.3kΩ/channel
Logic 1 signal		≥15VDC
Logic 0 signal		≤5VDC
Output specification		
Outputs		8
Output type		Relay
Voltage		250VAC, below 30VDC
Insulation		Mechanical insulation of relay
Action indication		The LED light is on when relay output contact closed
Minimum load		2mA/5VDC
Max. output current	Resistive load	2A/1point , The total current of 8 points of common COM terminal is less than 8A
	Inductive load	220VAC, 80VA
	Lamp load	220VAC, 100W
Response time	OFF→ON	Max.20ms
	ON→OFF	Max.20ms
Contact life		200,000 time

Small PLC

Medium PLC

X86 Controller

I/O System

HMI

Industrial Internet

● Analog input module



Model	IVC1L-2AD	
Product overview	2 analog inputs	
General		
Dimension	61×90×81.2mm	
Power	5V/GND	70mA
	24V/GND	-
Input specification		
Conversion speed	15ms/channel (normal speed), 6ms/channel (high speed), settable	
Range	Voltage input	-10V~+10V -5V~+5V
	Current input	-20mA~+20mA
Digital format	Default: -2000~+2000; Range: -10000~+10000	
Resolution	12 bit	
Accuracy	±1%FS	
Isolation	The optocoupler isolates analog circuit from digital circuit. The analog circuit is internally isolated from the 24VDC power supply of the module. No isolation between analog channels.	

Model	IVC1L-4AD	
Product overview	4 analog inputs	
General		
Dimension	61×90×81.2mm	
Power	5V/GND	70mA
	24V/GND	-
Input specification		
Conversion speed	15ms/channel (normal speed), 6ms/channel (high speed), settable	
Range	Voltage input	-10V~+10V -5V~+5V
	Current input	-20mA~+20mA
Digital format	Default: -2000~+2000; Range: -10000~+10000	
Resolution	12 bit	
Accuracy	±1%FS	
Isolation	The optocoupler isolates analog circuit from digital circuit. The analog circuit is internally isolated from the 24VDC power supply of the module. No isolation between analog channels.	

● Analog output module



Model	IVC1L-2DA	
Product overview	2 analog outputs	
General		
Dimension	61×90×81.2mm	
Power	5V/GND	72mA
	24V/GND	-
External power	24VDC (-15%~20%), Maximum allowable ripple voltage 5%,100mA	
Output specification		
Conversion speed	2ms/channel	
Range	Voltage output	-10V~+10V
	Current output	0~20mA 4~20mA
Digital format	Default: -2000~+2000; Range: -10000~+10000	
Resolution	12 bit	
Accuracy	±1%FS	
Isolation	The optocoupler isolates analog circuit from digital circuit. The analog circuit is internally isolated from the 24VDC power supply of the module. No isolation between analog channels.	

Model	IVC1L-4DA	
Product overview	4 analog outputs	
General		
Dimension	61×90×81.2mm	
Power	5V/GND	72mA
	24V/GND	-
External power	24VDC (-15%~20%), Maximum allowable ripple voltage 5%, 100mA	
Output specification		
Conversion speed	2ms/channel	
Range	Voltage output	-10V~+10V
	Current output	0~20mA 4~20mA
Digital format	Default: -2000~+2000; Range: -10000~+10000	
Resolution	12 bit	
Accuracy	±1%FS	
Isolation	The optocoupler isolates analog circuit from digital circuit. The analog circuit is internally isolated from the 24VDC power supply of the module. No isolation between analog channels.	

● Analog input/output module



Model		IVC1L-5AM	
Product overview		4 analog inputs, 1 analog output	
General			
Dimension		61×90×81.2mm	
Power	5V/GND	72mA	
	24V/GND	-	
Input specification			
Conversion speed		15ms/channel (normal speed), 8ms/channel (high speed), settable	
Voltage input		-10V~+10V -5V~+5V	
Range	Current input	-20mA~+20mA	
	Digital format	Default: -2000~+2000; Range: -10000~+10000	
Resolution		12 bit	
Accuracy		±1%FS	
Isolation		The optocoupler isolates analog circuit from digital circuit. The analog circuit is internally isolated from the 24VDC power supply of the module. No isolation between analog channels.	
Output specification			
Conversion speed		2ms/channel	
Voltage output		-10V~+10V	
Range	Current output	0~20mA 4~20mA	
	Digital format	Default: -2000~+2000; Range: -10000~+10000	
Resolution		12 bit	
Accuracy		±1%FS	
Isolation		The optocoupler isolates analog circuit from digital circuit. The analog circuit is internally isolated from the 24VDC power supply of the module. No isolation between analog channels.	

● Thermocouple module



Model		IVC1L-4TC	
Product overview		4 thermocouple	
General			
Dimension		61×90×81.2mm	
Power	5V/GND	72mA	
	24V/GND	-	
External power		24VDC (-15%~20%), Maximum allowable ripple voltage5%, 50mA	
Input specification			
Conversion speed		240ms/channel	
Input type		K/J/E/N/T/R/S type thermocouple	
Digital format	Celsius (0.1 ° C)	K type: -1000~+12000 E type: -1000~+10000 T type: -2000~+4000 S type: 0~16000	J type: -1000~+10000 N type: -1000~+12000 R type: 0~16000
	Fahrenheit (0.1 ° F)	K type: -1480~+21920 E type: -1480~+18320 T type: -3280~+7520 S type: 320~29120	J type: -1480~+18320 N type: -1480~+21920 R type: 320~29120
Resolution		0.5 ° C/0.9 ° F; 12bit	
Accuracy		±0.5%FS+1 ° C	
Isolation		The optocoupler isolates analog circuit from digital circuit. The analog circuit is internally isolated from the 24VDC power supply of the module. No isolation between analog channels.	



Model		IVC1L-2TC	
Product overview		2 thermocouple	
General			
Dimension		61×90×81.2mm	
Power	5V/GND	72mA	
	24V/GND	-	
External power		24VDC (-15%~20%), Maximum allowable ripple voltage5%, 50mA	
Input specification			
Conversion speed		240ms/channel	
Input type		K/J/E/N/T/R/S type thermocouple	
Digital format	Celsius (0.1 ° C)	K type: -1000~+12000 E type: -1000~+10000 T type: -2000~+4000 S type: 0~16000	J type: -1000~+10000 N type: -1000~+12000 R type: 0~16000
	Fahrenheit (0.1 ° F)	K type: -1480~+21920 E type: -1480~+18320 T type: -3280~+7520 S type: 320~29120	J type: -1480~+18320 N type: -1480~+21920 R type: 320~29120
Resolution		0.5 ° C/0.9 ° F; 12bit	
Accuracy		±0.5%FS+1 ° C	
Isolation		The optocoupler isolates analog circuit from digital circuit. The analog circuit is internally isolated from the 24VDC power supply of the module. No isolation between analog channels.	

● Thermal resistance module



Model		IVC1L-2PT
Product overview		2 thermal resistance
General		
Dimension		61×90×81.2mm
Power	5V/GND	72mA
	24V/GND	—
External power		24VDC (-15%~20%), Maximum allowable ripple voltage5%, 50mA
Input specification		
Conversion speed		15ms/channel
Input type		Pt100/Cu100/Cu50
Digital format	Celsius (0.1 ° C)	Pt100: -1500~+6000 Cu100: -300~+1200 Cu50: -300~+1200
	Fahrenheit (0.1 ° F)	Pt100: -2380~+11120 Cu100: -220~+2480 Cu50: -220~+2480
Resolution		0.2 ° C/0.36 ° F; 12bit
Accuracy		±1%FS
Isolation		The optocoupler isolates analog circuit from digital circuit. The analog circuit is internally isolated from the 24VDC power supply of the module. No isolation between analog channels.

Model		IVC1L-4PT
Product overview		4 thermal resistance
General		
Dimension		61×90×81.2mm
Power	5V/GND	72mA
	24V/GND	—
External power		24VDC (-15%~20%), Maximum allowable ripple voltage5%, 50mA
Input specification		
Conversion speed		15ms/channel
Input type		Pt100/Cu100/Cu50
Digital format	Celsius (0.1 ° C)	Pt100: -1500~+6000 Cu100: -300~+1200 Cu50: -300~+1200
	Fahrenheit (0.1 ° F)	Pt100: -2380~+11120 Cu100: -220~+2480 Cu50: -220~+2480
Resolution		0.2 ° C/0.36 ° F; 12bit
Accuracy		±1%FS
Isolation		The optocoupler isolates analog circuit from digital circuit. The analog circuit is internally isolated from the 24VDC power supply of the module. No isolation between analog channels.

IVC1L extension module dimension

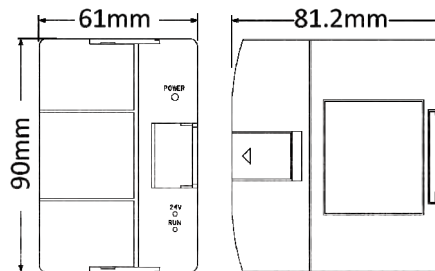

Model	Dimension
IVC1L extension module	61×90×81.2mm

IVC1L extension module wiring diagram

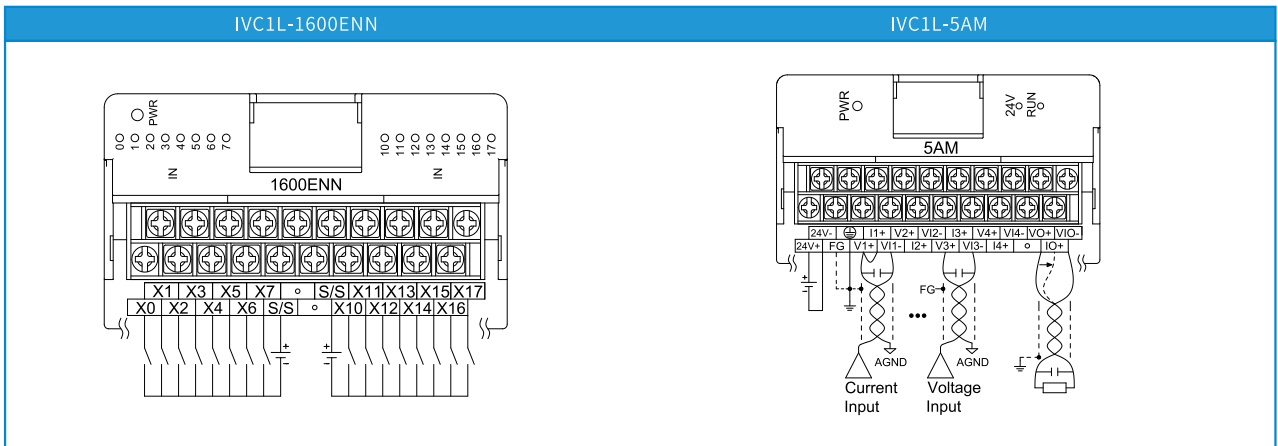
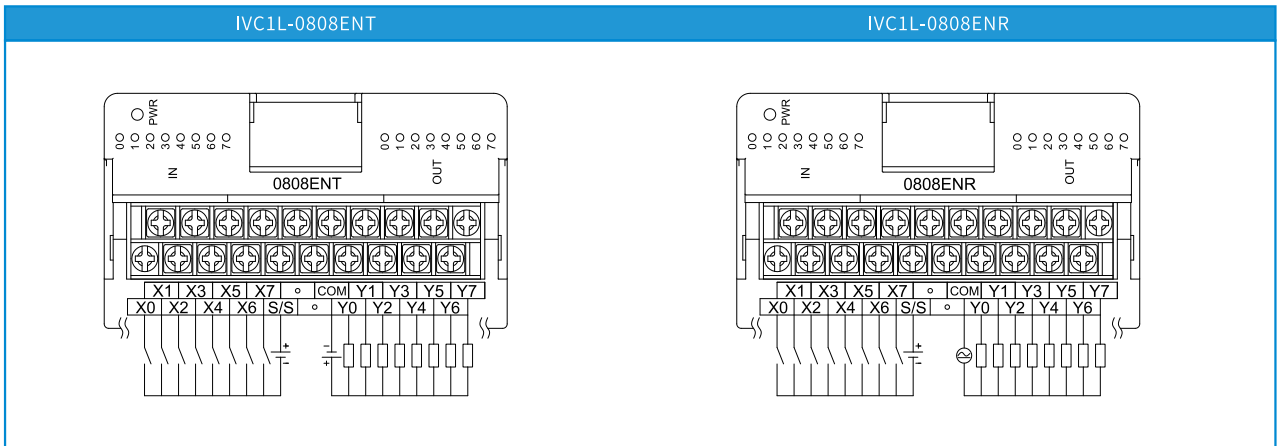
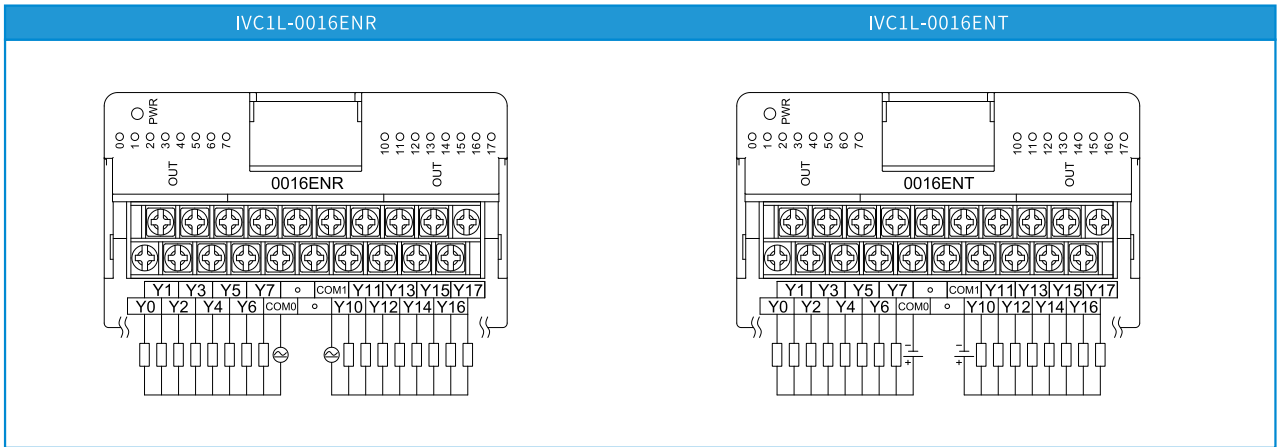

Small PLC
Medium PLC
X86 Controller
I/O System
HMI
Industrial Internet

IVC1L-2AD

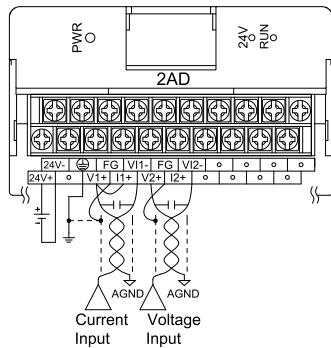

IVC1L-4AD

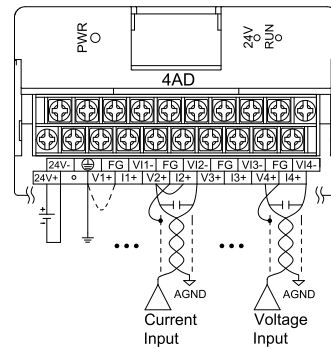

IVC1L-2DA

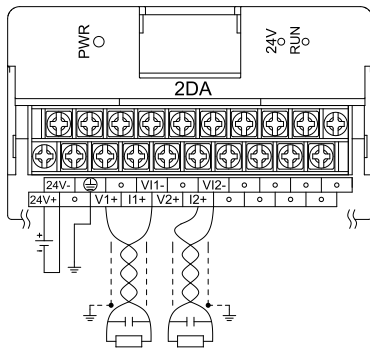

IVC1L-4DA

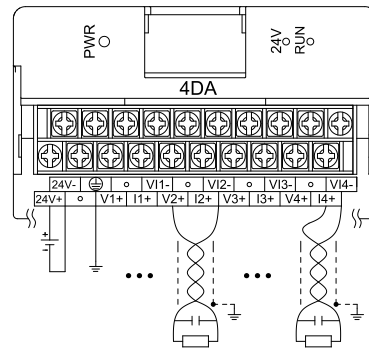

IVC1L-2PT/IVC1L-4PT

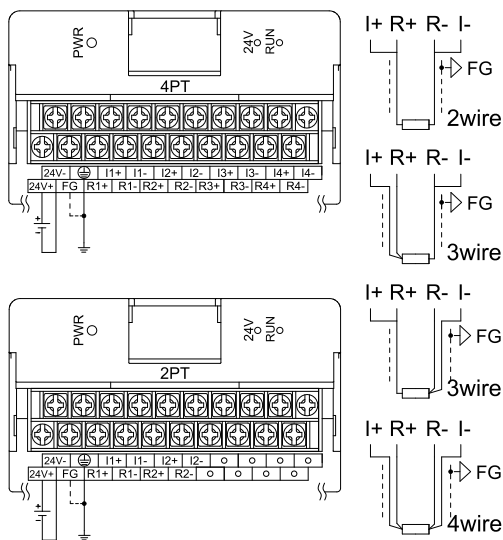

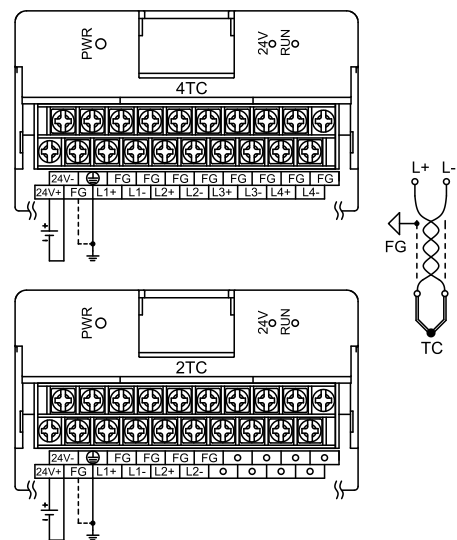

IVC1L-2TC/IVC1L-4TC



IVC PLC spare part

Product type	Description	Photo
IVC-SL1	PLC-VS HMI 232 communication cable(2m)	

Product type	Description	Photo
IVC-SL5	PLC-VT/VK/VA HMI 232 communication cable(7m)	

Product type	Description	Photo
IVC-SL2	PLC download cable, USB-RS232(Port0) (2m)	

Product type	Description	Photo
IVC-SL8	PLC-VS HMI 232 communication cable(7m)	

Product type	Description	Photo
IVC-SL3	PLC-VT/VK/VA HMI 232 communication cable(3m)	

Product type	Description	Photo
IVC-SL9	IVC1L extension cable(1m)	

Product type	Description	Photo
IVC-SL4	HMI download cable, available for VT/VK/VA/VS series(2m)	

Small PLC

Medium PLC

X86 Controller

I/O System

HMI

Industrial Internet

TS600 Series Intelligent PLC

INVT TS600 series intelligent PLC integrates high-performance embedding technology, and it is based on a high-speed bus system architecture to integrate four types of automation control, namely, sequence, process, information, and motion control, into the same system. It achieves the real-time control and complex calculation through the highly reliable software and hardware real-time system, and provides open communication interfaces, IoT networks, and distributed module system architecture. The completely independent programming software provides customized services, making programming easy.

TS600 can work with INVT VFD, servo, HMI, IoT and other products to construct one-stop automation solutions to create value for customers.



Product positioning



Product positioning

Running efficiently

1G main frequency, compile command breakthrough, bit operation speeding up to 0.01μs

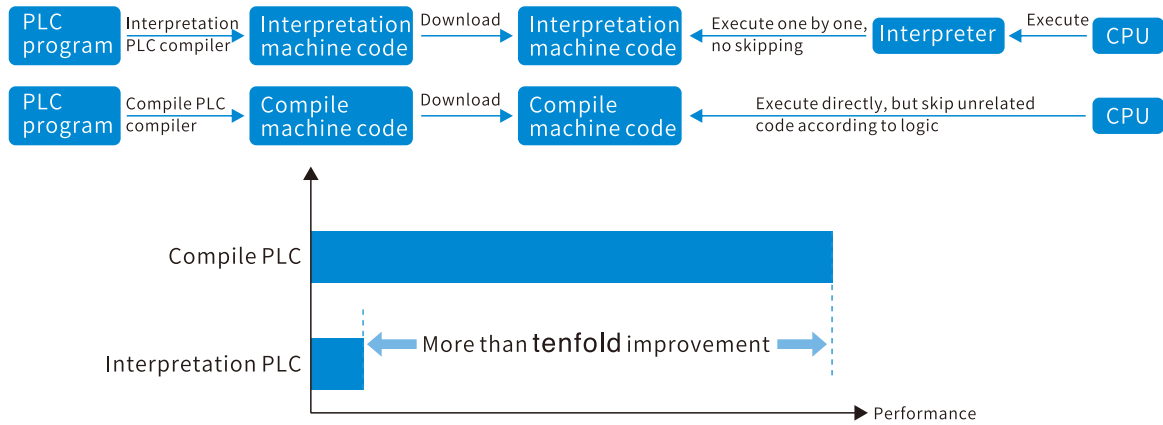

100Mbps backplane bus; 125μs IO refresh speed; plating process, reliable connection; saving data at power down, 1s power-down ride-through



Product positioning

High-speed motion control, easily implementing complex processes

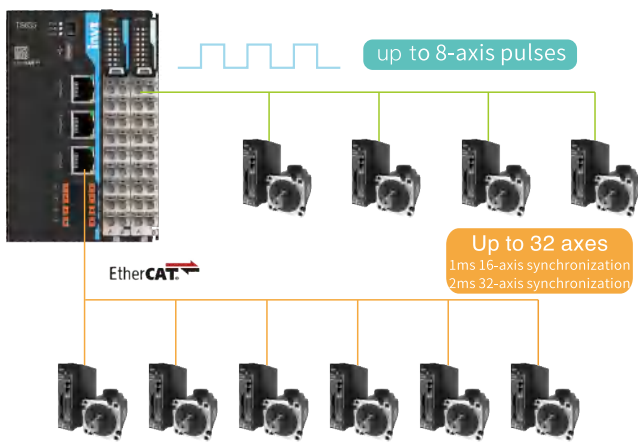

Single-axis control	Multi-axis control	Flying shear
speed and torque control	E-gear	
Position control	E-CAM	Chasing shear
Homing	Interpolation	

Small PLC
Medium PLC
X86 Controller
I/O System
HMI
Industrial Internet

Easy connection

Multi-protocol support facilitates interconnection

- ▣ Dual-port design, makes cascading easy, and achieves the isolation between the internal network and external network

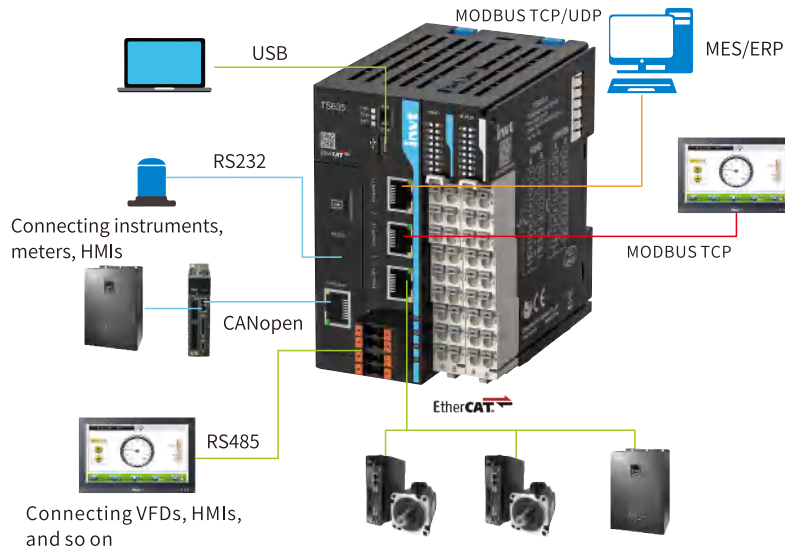

* Ethernet IP master/slave nodes supported

Easy programming

- ▣ Equipped with the brand new AutoStationPro

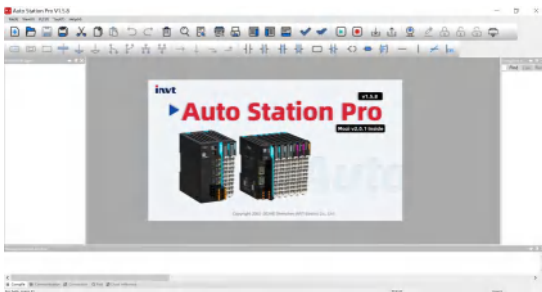

- ▣ Supporting user-defined variables

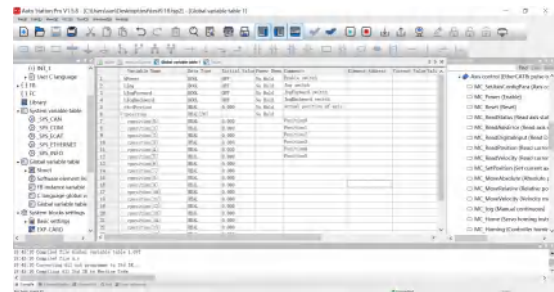

- ▣ Compliant with IEC61131 programming specifications, supporting the languages LD, SFC, IL, C, and ST (under development). The pulse and bus axes are compatible with a set of axis control commands.

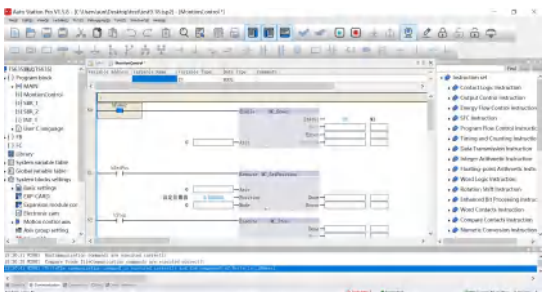

- ▣ Supporting graphic configuration through dragging, Easy parameter setup and automatic address allocation

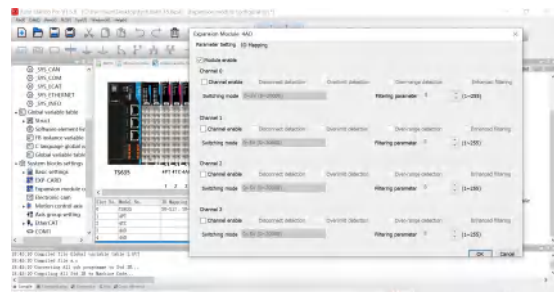

Trace function

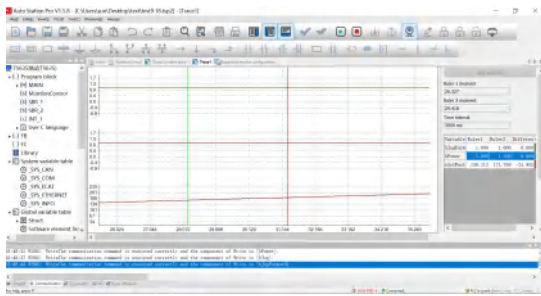

Easy scalability

Standard configuration of CPU

- 8/16 points of DI
- 8 200kHz high-speed inputs
- 8/16 points of DO
- 8/16 200kHz high speed outputs

Compatible with Flex series I/O modules for scaling

- Up to 16 I/O modules can be expanded locally
- Use of push-in terminals, facilitating wiring
- Vertical plug-in assembly, with working time reduced by 80%
- Mounting space reduced by more than 60%, compared with traditional modules

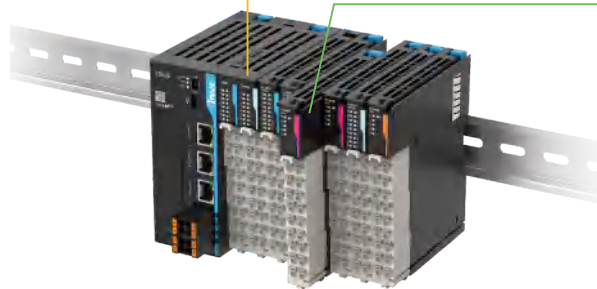

*TS620 and TS630 are equipped with 8 digital inputs and 8 digital outputs. TS611, TS621, and TS621P support 16 channels of 200kHz high-speed output.

Supporting various expansion cards

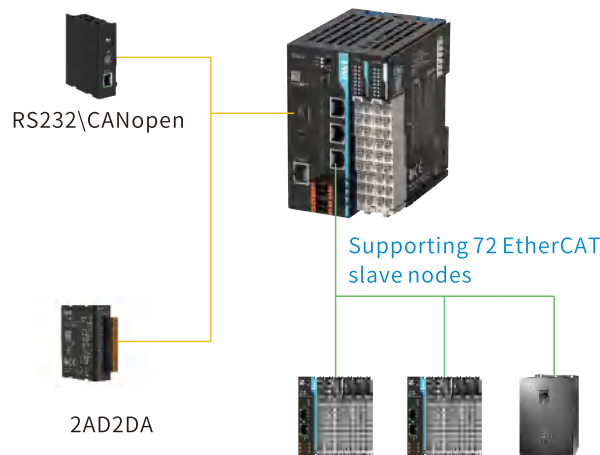

Product specifications



Model	TS635	TS634	TS634P	TS633	TS633P	TS630	TS621	TS621P	TS620	TS620R	TS611	
General specifications												
EtherNet interface	2	2	2	2	2	1	2	2	1	1	-	
EtherCAT interface	1	1	1	1	1	1	-	-	-	-	-	
Max. number of axes (bus+pulse)	32 (bus) +4 (pulse)	16 (bus) +4 (pulse)	16 (bus) +4 (pulse)	8 (bus) +4 (pulse)	8 (bus) +4 (pulse)	8 (bus) +4 (pulse)	8 (pulse)	8 (pulse)	4 (pulse)	-	8 (pulse)	
RS485 bus	2 channels, supporting Modbus RTU master/slave function											
EtherNet bus	Supporting Modbus TCP/UDP, program upload and download, and firmware upgrade										-	
USB interface	1 channel, Type-C interface, supporting program upload and download, and firmware upgrade											
DI	16 inputs originally, including eight 200kHz high-speed inputs					8 inputs originally, including eight 200kHz high-speed inputs	16 inputs originally, including eight 200kHz high-speed inputs	8 inputs originally, including eight 200kHz high-speed inputs	8 inputs originally, including eight 200kHz high-speed inputs	16 inputs originally, including eight 200kHz high-speed inputs		
DO	16 outputs originally, including eight 200kHz high-speed outputs					8 outputs originally, including eight 200kHz high-speed outputs	16 outputs originally, including sixteen 200kHz high-speed outputs	8 outputs originally, including eight 200kHz high-speed outputs	6 outputs originally, Relay outputs	16 outputs originally, including sixteen 200kHz high-speed outputs		
Pulse axis	up to 4 axes						up to 8 axes		up to 4 axes	-	up to 8 axes	
Input power	24V DC (-15% – +20%)/1A, supporting reversal protection											
Standalone power consumption	<3W											
Backplane bus power supply	5V/2.5A											
Power-down protection	Supported (retention by the internal flash)											
Real-time clock	Supported (CR2032 battery is optional; the real-time clock works about four days without a battery)											
Local expansion modules	Expand Flex series I/O, Up to 16, disallowing hot swapping											
Local expansion card	1 expansion card, supporting SD card, CANopen card, RS232 card and so on											
Program language	LD, SFC, IL, and C											
Program download	USB port, Ethernet port, SD card (expansion card), and remote download (expansion card)											
Program data capacity	200K steps of user program 2MByte user-defined variables, in which 128KByte support power-down retention About 150K soft elements, the soft elements numbered after 1000 support power-down retention											
Command speed (step)	20K steps at 0.2ms											
Bit handling command	0.0127μs											
Word transmission command	0.0014μs											
Floating-point transmission command	0.0027μs											
Four operations of math	0.033μs											
Power specifications												
Terminal input power rated voltage	24V DC											
Terminal input power rated current	1A											
24V input power protection	Protection against reverse connection and surges											
Hot swapping of module	Not supported											

Model	TS635	TS634	TS634P	TS633	TS633P	TS630	TS621	TS621P	TS620	TS620R	TS611	
Input specifications												
Input type	digital input											
Number of input channels	16				8		16		8		16	
Input mode	Source and sink											
Input voltage class	24VDC(-10%~+10%)											
Input current	Typical value for X0-X7: 13.5mA; Typical value for X10-X17: 4.2mA				Typical value for X0-X7: 17.5mA		Typical value for X0-X7: 13.5mA; Typical value for X10-X17: 4.2mA		Typical value for X0-X7: 17.5mA		Typical value for X0-X7: 13.5mA; Typical value for X10-X17: 4.2mA	
Max. input frequency	200kHz for X0-X7; 200Hz for X10-X17				200kHz for X0-X7		200kHz for X0-X7; 200Hz for X10-X17		200kHz for X0-X7		200kHz for X0-X7; 200Hz for X10-X17	
Input resistance	Typical value for X0-X7: 1.7kΩ; Typical value for X10-X17: 5.7kΩ				Typical value for X0-X7: 1.3kΩ		Typical value for X0-X7: 1.7kΩ; Typical value for X10-X17: 5.7kΩ		Typical value for X0-X7: 1.3kΩ		Typical value for X0-X7: 1.7kΩ; Typical value for X10-X17: 5.7kΩ	
ON voltage	≥ 15VDC											
OFF voltage	≤ 5VDC											
Isolation method	Capacitive isolation											
Common terminal method	8 channels/group											
Input action display	When the input is in the driving state, the input indicator is on (software control)											
Output specifications												
Output type	Transistor output											
Number of output channels	16				8		16		8		-	16
Output mode	sink	Source	sink	Source	sink	sink	Source	sink	-	-	sink	
Output voltage class	24VDC(-10%~+10%)											
Output load (resistive)	0.5A/point, 2A/group											
output load (inductive)	7.2W/point, 24W/group											
Hardware response time	<2us											
Load current requirement	Load current ≥ 12mA when output frequency is greater than 10kHz											
Max. output frequency	200kHz for resistive load, 0.5Hz for inductive load, and 10Hz for lighting load											
Leakage current at OFF	Below 30μA (24V typical voltage)											
Max. residual voltage at ON	≤ 0.5VDC											
Isolation method	Optocoupler isolation											
Common terminal method	8 channels/group											
Short-circuit protection function	Supported											
External inductive load requirement	Flyback diode needed for external inductive load connection											
Output action display	When the output is valid, the output indicator is on (software control)											
Output derating	The current at each common terminal group cannot exceed 1A at ambient temperature of 55°C											
TS620R Output specifications												
Output type	Relay output											
Output mode	Dry node											
Number of output channels	6											
Output voltage class	250VAC/30VDC											
Maximum switching voltage	250VAC/125VDC (@0.3A)											
Output load (resistive load)	3A/point, 8A/module											
Output load (Inductive load)	1A/point, 4A/module											
Output load (lamp load)	30W/point, 120W/module											
contact resistance	<100mΩ (1A 6VDC)											
Minimum load	5VDC 10mA											
Mechanical life	20,000,000 times											
Electrical life	100,000 times											
Isolation method	High voltage/Low voltage isolation											

Expansion card specifications



Model	TS-CAN-232
Product description	TS600 series expansion card, which supports Micro SD cards, CANopen bus, and one channel of RS232 communication
IP rating	IP20
Working temperature	-20°C~55°C
Terminal resistor	Built-in terminal resistor, which can be selected through the dial switch
RS232	1
CAN communication baud rate	1Mbps: Distance<20m 500Kbps: Distance<80m 250Kbps: Distance<150m 125Kbps: Distance<300m 100Kbps: Distance<500m 50Kbps: Distance<1000m
SD card capacity	Up to 32GB
SD card specifications	Micro SD
SD card communication interface	SDIO
Hot swapping	Supported by SD cards, but not supported by the expansion card



Model	EC-CAN
Product description	TS/TM series expansion card, 2*RJ45, 1*MicroSD card (SD card only supports TS series)
IP rating	IP20
Working temperature	-20°C~55°C
Terminal resistor	Built-in terminal resistor, which can be selected through the dial switch
CAN communication baud rate	1Mbps: Distance<20m 500Kbps: Distance<80m 250Kbps: Distance<150m 125Kbps: Distance<300m 100Kbps: Distance<500m 50Kbps: Distance<1000m
SD card capacity	Up to 32GB
SD card specifications	Micro SD
SD card communication interface	SDIO
Hot swapping	Supported by SD cards, but not supported by the expansion card



Model	EC-2AD2DA
Product description	TS/TM series analog expansion card, 2-channel analog input, 2-channel analog output
Hot swapping	Not supported
Number of input channels	2 channels
Voltage input range	0~10V, 0~5V, 1~5V
Current input range	0~20mA, 4~20mA
Input accuracy (normal temperature 25°C)	Voltage $\pm 1\%$, Current $\pm 1\%$
Input accuracy (full temperature range)	Voltage $\pm 3\%$, Current $\pm 3\%$
Input resolution	12bit
Digital input	0~20000
Number of output channels	2 channels
Voltage output range	0~10V, 0~5V, 1~5V
Current output range	0~20mA, 4~20mA
Output accuracy (normal temperature 25°C)	$\pm 1\%$
Output accuracy (full temperature range)	$\pm 5\%$
Output resolution	12bit
Digital output	0~20000

IVC PLC product list

Material code	Model	Description	Dimension
● IVC1L main module ●			
11060-00076	IVC1L-0806MAR	8 digital inputs, 6 relay outputs, AC220V power supply	135×90×81.2mm
11060-00077	IVC1L-0806MAT	8 digital inputs, 6 transistor outputs, AC220V power supply	135×90×81.2mm
11060-00070	IVC1L-1410MAR	14 digital inputs, 10 relay outputs, AC220V power supply	135×90×81.2mm
11060-00071	IVC1L-1410MAT	14 digital inputs, 10 transistor outputs, AC220V power supply	135×90×81.2mm
11060-00068	IVC1L-1614MAR	16 digital inputs, 14 relay outputs, AC220V power supply	150×90×81.2mm
11060-00069	IVC1L-1614MAT	16 digital inputs, 14 transistor outputs, AC220V power supply	150×90×81.2mm
11060-00066	IVC1L-1614MAR1	16 digital inputs, 14 relay outputs, integrated 2AI and 1AO, AC220V power supply	182×90×81.2mm
11060-00067	IVC1L-1614MAT1	16 digital inputs, 14 transistor outputs, integrated 2AI and 1AO, AC220V power supply	182×90×81.2mm
11060-00064	IVC1L-2416MAR	24 digital inputs, 16 relay outputs, AC220V power supply	182×90×81.2mm
11060-00065	IVC1L-2416MAT	24 digital inputs, 16 transistor outputs, AC220V power supply	182×90×81.2mm
11060-00062	IVC1L-3624MAR	36 digital inputs, 24 relay outputs, AC220V power supply	224.5×90×81.2mm
11060-00063	IVC1L-3624MAT	36 digital inputs, 24 transistor outputs, AC220V power supply	224.5×90×81.2mm
11060-00198	IVC1L-1616MAR6	24 digital inputs, 16 relay outputs, integrated 2 thermal resistor (PT), AC220V power supply	182×90×81.2mm
11060-00139	IVC1L-0806MDR	8 digital inputs, 6 relay outputs, DC24V power supply	135×90×81.2mm
11060-00138	IVC1L-0806MDT	8 digital inputs, 6 transistor outputs, DC24V power supply	135×90×81.2mm
11060-00143	IVC1L-1410MDR	14 digital inputs, 10 relay outputs, DC24V power supply	135×90×81.2mm
11060-00142	IVC1L-1410MDT	14 digital inputs, 10 transistor outputs, DC24V power supply	135×90×81.2mm
11060-00145	IVC1L-1614MDR	16 digital inputs, 14 relay outputs, DC24V power supply	150×90×81.2mm
11060-00144	IVC1L-1614MDT	16 digital inputs, 14 transistor outputs, DC24V power supply	150×90×81.2mm
11060-00147	IVC1L-2416MDR	24 digital inputs, 16 relay outputs, DC24V power supply	182×90×81.2mm
11060-00146	IVC1L-2416MDT	24 digital inputs, 16 transistor outputs, DC24V power supply	182×90×81.2mm
11060-00149	IVC1L-3624MDR	36 digital inputs, 24 relay outputs, DC24V power supply	224.5×90×81.2mm
11060-00148	IVC1L-3624MDT	36 digital inputs, 24 transistor outputs, DC24V power supply	224.5×90×81.2mm
● IVC1L extension module ●			
11060-00207	IVC1L-0808ENR	8 digital inputs, 8 relay outputs	61×90×81.2mm
11060-00204	IVC1L-0808ENT	8 digital inputs, 8 transistor outputs	61×90×81.2mm
11060-00205	IVC1L-1600ENN	16 digital inputs	61×90×81.2mm
11060-00217	IVC1L-0016ENT	16 transistor outputs	61×90×81.2mm
11060-00206	IVC1L-0016ENR	16 relay outputs	61×90×81.2mm
11060-00214	IVC1L-2AD	2 analog input	61×90×81.2mm
11060-00212	IVC1L-2DA	2 analog outputs	61×90×81.2mm
11060-00215	IVC1L-2TC	2 thermocouple	61×90×81.2mm
11060-00216	IVC1L-2PT	2 thermal resistance	61×90×81.2mm
11060-00209	IVC1L-4AD	4 analog inputs	61×90×81.2mm
11060-00208	IVC1L-4DA	4 analog outputs	61×90×81.2mm
11060-00210	IVC1L-4TC	4 thermocouple	61×90×81.2mm
11060-00213	IVC1L-4PT	4 thermal resistance	61×90×81.2mm
11060-00211	IVC1L-5AM	4 analog inputs, 1 analog output	61×90×81.2mm

Material code	Model	Description	Dimension
● IVC PLC spare part ●			
67005-00004	IVC-SL1	PLC-VS HMI 232 communication cable (2m)	2m
67005-00001	IVC-SL2	PLC download cable, USB-RS232 (Port0)(2m)	2m
67005-00002	IVC-SL3	PLC-VT/VK/VA HMI 232 communication cable (3m)	3m
67005-00003	IVC-SL4	HMI download cable, available for VT/VK/VA/VS series (2m)	2m
67005-00259	IVC-SL5	PLC-VT/VK/VA HMI 232 communication cable (7m)	7m
67005-00391	IVC-SL8	PLC-VS HMI 232 communication cable (7m)	7m
67005-00392	IVC-SL9	IVC1L extension cable (1m)	1m
● TS600 main module ●			
11060-00315	TS611	16 inputs and 16 transistor outputs, 1×USB (TypeC), 2×RS485, 8 channels of 200K input, 16 channels of 200K output, up to 8 axes (pulse axes)	CE
11060-00328	TS620	8 inputs and 8 transistor (NPN) outputs, 1×USB (Type-C), 2×RS485, 8 channels of 200K input, 8 channels of 200K output, 1×EtherNet, up to 4 axes (pulse axes)	CE
11060-00331	TS620R	8 inputs and 6 relay outputs, 1×USB (Type-C), 2×RS485, eight 200K inputs, 1×EtherNet	CE
11060-00318	TS621	16 inputs and 16 transistor outputs, 1×USB (Type-C), 2×RS485, 8 channels of 200K input, 16 channels of 200K output, 2×EtherNet, up to 8 axes (pulse axes)	CE
11060-00323	TS621P	16 inputs and 16 transistor (PNP) outputs, 1×USB (Type-C), 2×RS485, 8 channels of 200K input, 16 channels of 200K output, 2×EtherNet, up to 8 axes (pulse axes)	CE
11060-00329	TS630	8 inputs and 8 transistor (NPN) outputs, 1×USB (Type-C), 2×RS485, 8 channels of 200K input, 8 channels of 200K output, 1×EtherNet, 1×EtherCAT, up to 12 axes (8 bus axes + 4 pulse axes)	CE
11060-00317	TS633	16 inputs and 16 transistor outputs, 1×USB (Type-C), 2×RS485, 8 channels of 200K input, 8 channels of 200K output, 2×EtherNet, 1×EtherCAT, up to 12 axes (8 bus axes + 4 pulse axes)	CE
11060-00324	TS633P	16 inputs and 16 transistor (PNP) outputs, 1×USB (Type-C), 2×RS485, 8 channels of 200K input, 8 channels of 200K output, 2×EtherNet, 1×EtherCAT, up to 12 axes (8 bus axes + 4 pulse axes)	CE
11060-00316	TS634	16 inputs and 16 transistor outputs, 1×USB (Type-C), 2×RS485, 8 channels of 200K input, 8 channels of 200K output, 2×EtherNet, 1×EtherCAT, up to 20 axes (16 bus axes + 4 pulse axes)	CE
11060-00325	TS634P	16 inputs and 16 transistor (PNP) outputs, 1×USB (Type-C), 2×RS485, 8 channels of 200K input, 8 channels of 200K output, 2×EtherNet, 1×EtherCAT, up to 20 axes (16 bus axes + 4 pulse axes)	CE
11060-00312	TS635	16 inputs and 16 transistor outputs, 1×USB (Type-C), 2×RS485, 8 channels of 200K input, 8 channels of 200K output, 2×EtherNet, 1×EtherCAT, up to 36 axes (32 bus axes + 4 pulse axes)	CE
● TS600 series expansion card module ●			
11060-00313	TS-CAN-232	TS600 series expansion card TS-CAN-232, which supports Micro SD cards, CANopen bus, and one channel of RS232 communication	CE
11060-00332	EC-CAN	TS/TM series expansion card, 2×RJ45, 1×MicroSD card (SD card only supports TS series)	CE
11060-00333	EC-2AD2DA	TS/TM series analog expansion card, 2-channel analog input, 2-channel analog output	CE

Medium PLC

Industrial control technology based on the CODESYS platform



The TM700 series high-performance programmable controller is mainly designed for scenarios with high motion control requirements and complex control networks. It has significant improvements in control performance, communication capabilities, and programming efficiency, allowing you to build control networks flexibly. Through OPCUA, the data interaction with the information layer is more convenient, further improving device takt time, shortening development cycles, and bringing an enhanced experience.

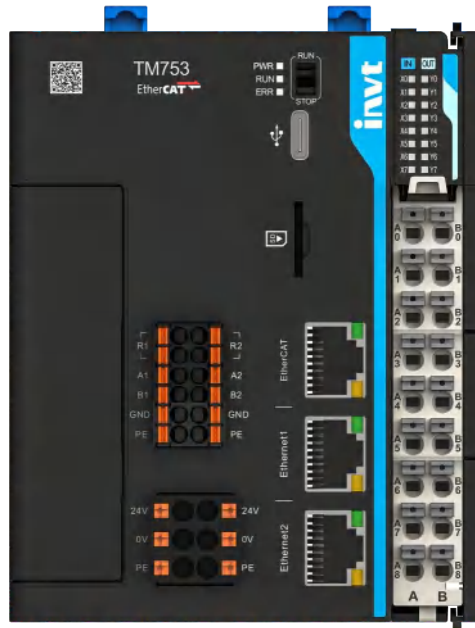

Powerful motion control

EtherCAT bus control is available, with standard PLCOpen motion control function, supported by industry process packages, enabling rapid development of motion control programs.



Informationization

The module supports multiple international standard communication networks, flexible construction of multi-level open communication networks, and seamless integration with upper level systems such as MES/ERP through OPC UA.



Cloud collaboration

With Extcard for functional extensions such as 4G and Wi-Fi, remote operation and maintenance and digital management of devices are available through the IWoCloud cloud platform and IWoScience IoT business system.



Easy programming

Multiple programming languages are supported, including LD, IL, SFC, CFC, FBD, and ST, and servo and VFD debugging can be conducted through Invtmatic Studio, significantly enhancing programming efficiency.

Powerful motion control

- 1ms@16 axes EtherCAT bus motion control, achieving multi-axis collaboration, significantly shortening the takt time
- 8 high-speed inputs and 8 high-speed outputs integrated, supporting functions such as encoder input, hardware latch, high-speed comparison output, and pulse axis. It has precise position control and is widely used in labeling, flying trigger and other scenarios



A0-A7: 8 high-speed inputs

- Four high-speed counters
- Probe, reset, preset value input

B0-B7: 8 high-speed outputs

- 4 groups of pulse axis
- 4 groups of PWM output
- 4 high-speed comparison outputs

- Supporting BufferMode function for smooth motion, reducing impact on machinery and improving productivity

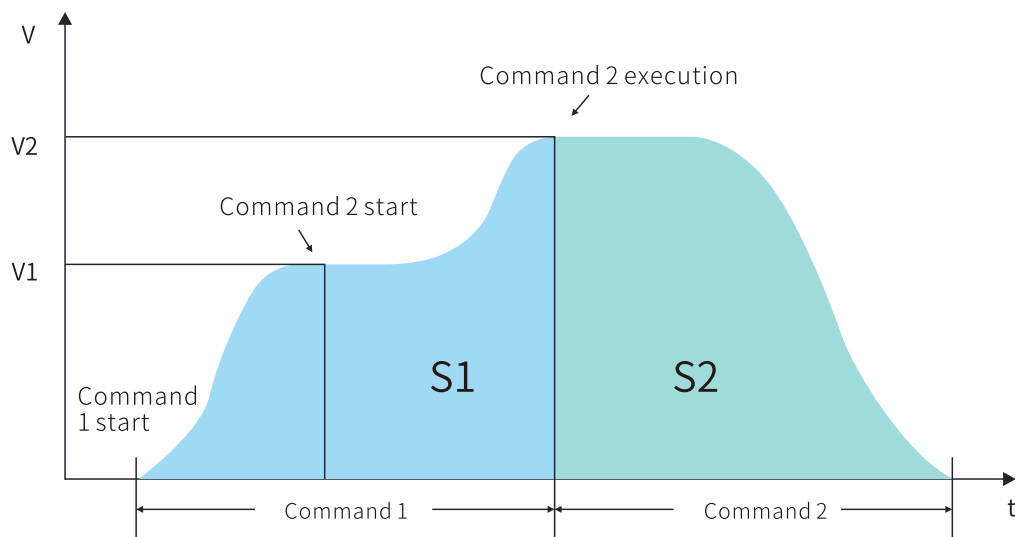

Continuous and uninterrupted BufferMode speed

- Supporting high-order motion control of electronic cams and gears

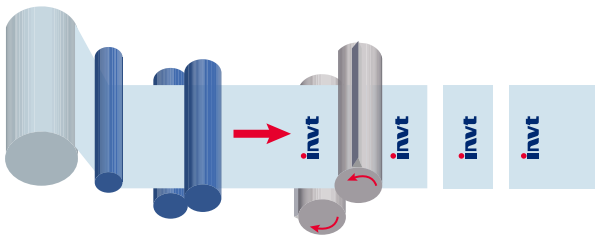

Flying shear

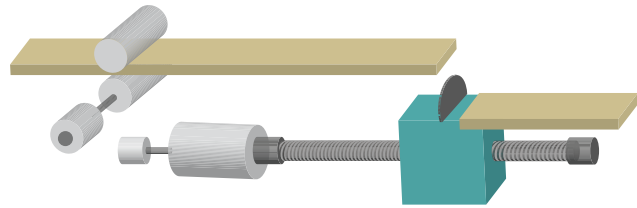

Linear flying shear

- Supporting multiple interpolation functions, such as linear interpolation, arc interpolation, and spiral interpolation

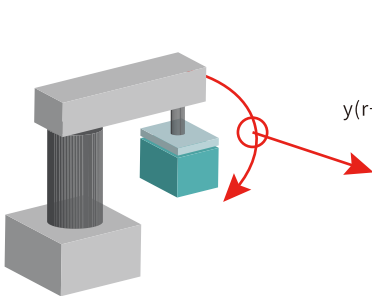

Arc interpolation

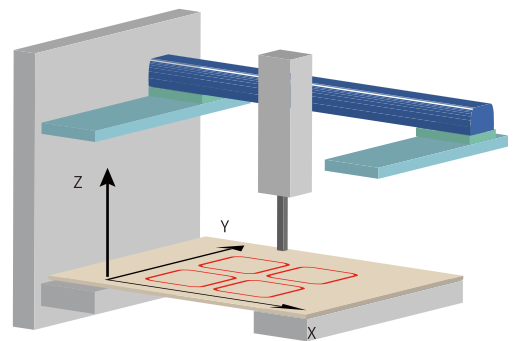
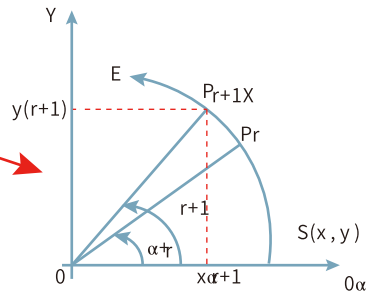

Multi-axis linear interpolation

- Supporting axis group function, with kinematic models integrating with multiple standards, easily achieving control of various types of robotic arms

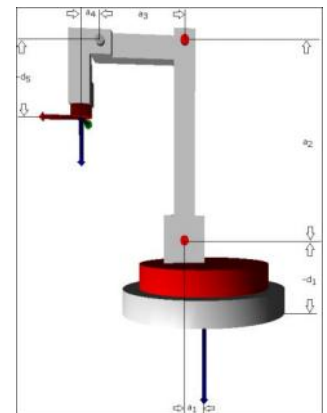
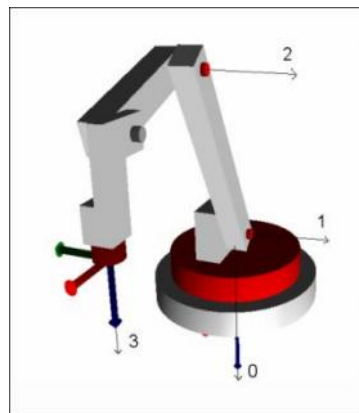
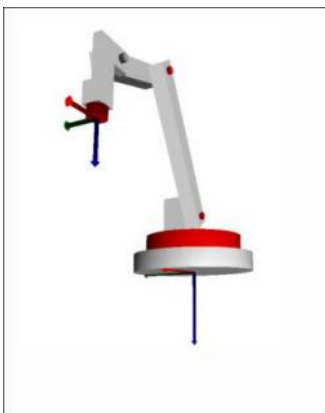

- Industry-specific process libraries, integrated with a wealth of industry-specific process instructions, reducing the difficulty of process development and shortening the solution development cycle

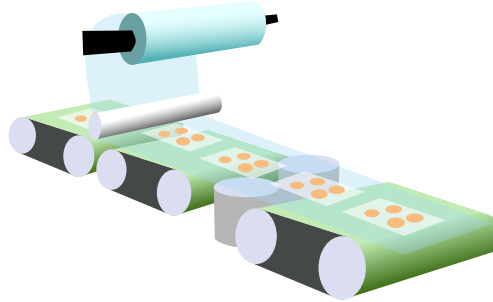

Process library for packaging industry

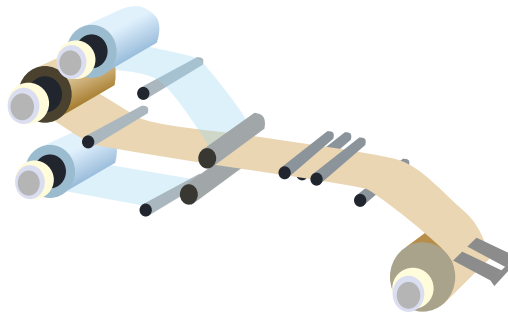

Winding and unwinding process library

Efficient network

- Supporting rich network interfaces and protocols, EtherCAT, ModbusTCP, TCP/IP, UDP, EtherNet/IP, Modbus RTU, and CANopen, enabling a multi-level network structure and flexible construction of control network
- OPC UA, tag communication, allowing efficient information exchange with simple configuration

Digitalization

- With the help of INVT IWoScience IoT business system, remote management, maintenance, analysis, and monitoring of equipment can be achieved. It has a friendly interface, simple operation, and complete functions, solving the problems of inconvenient management, maintenance, and monitoring in the application industry due to the complex environment where the equipment is located, making the work smarter and more efficient

Remote O&M

- The Extcard can be used to extend functions such as CANopen, 4G, Wi-Fi, etc. It can also achieve remote PLC debugging, program updates, firmware updates, and other functions with just one click through INVT WoCloud cloud platform

Remote O&M

- The Extcard can be used to extend functions such as CANopen, 4G, Wi-Fi, etc. It can also achieve remote PLC debugging, program updates, firmware updates, and other functions with just one click through INVT WoCloud cloud platform

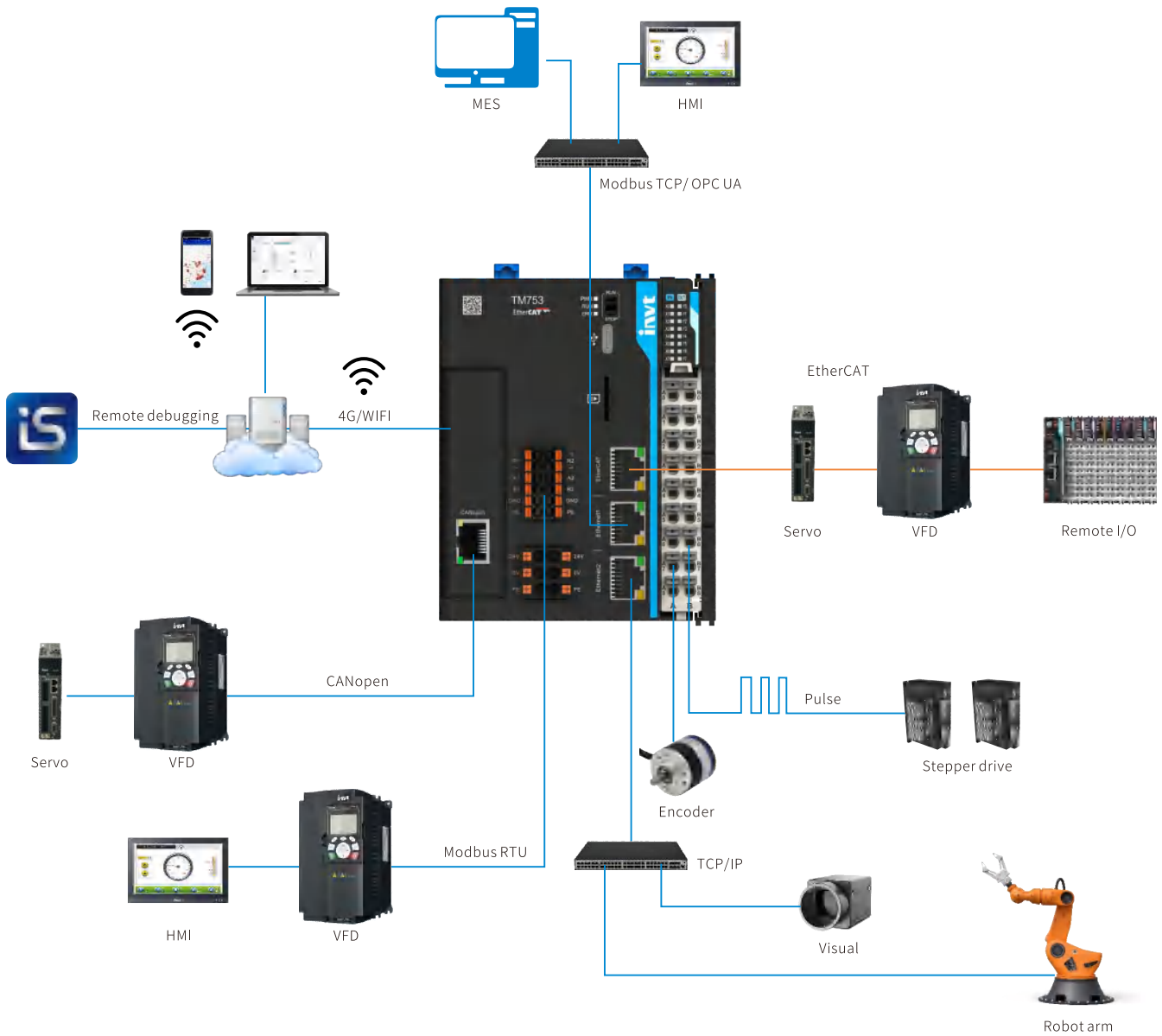

Easy programming

- Visibility of variable usage helps with program optimization and troubleshooting

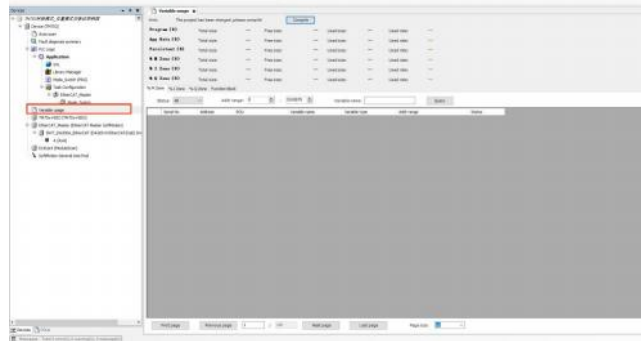

- Host controller reads and writes servo function codes and VFD function codes, making it easy to debug

No.	Parameter Name	Unit	Default Value	Min.	Max.	Resolution	Bit Type	Bit No.	Bit No. (Hex)	Function
P0.01	Motor Type		1	1	1		Bit	0017	0017	Phase voltage...
P0.02	Encoder type selection		1	1	1		Bit	0018	0018	Set the Encoder...
P0.03	Motor Forward Direction		0	1	0		Bit	0019	0019	Set the Forward...
P0.04	Control Mode Selection		0	1	0		Bit	0020	0020	Choose the Acti...
P0.05	Internal sensor enable		0	1	0		Bit	0021	0021	Internal enable...
P0.06	Axis speed	mm/s	1000	200	10000	1	Bit	0022	0022	Set the speed...
P0.07	Number of encoder pulse output		10000	1	10000	1	Bit	0023	0023	Number of P...
P0.08	Encoder of encoder pulse No.		1	1	1		Bit	0024	0024	Encoder of e...
P0.09	Public brake direction inverting		0	1	0		Bit	0025	0025	The normal o...
P0.10	Transtop mode selection		0	1	0		Bit	0026	0026	Parameter sel...
P0.11	stop Transstop	%	500	200	1000	1	Bit	0027	0027	Max. transtop...
P0.12	Phase of the external braking...		0	1	0		Bit	0028	0028	Max. transtop...
P0.13	Phase of the external braking...		0	1	0		Bit	0029	0029	Set the brake...
P0.14	Phase of the external braking...		0	1	0		Bit	0030	0030	Set the brake...
P0.15	Default movement parameters		0	1	0		Bit	0031	0031	Set the default...
P0.16	Character modification enable		0	1	0		Bit	0032	0032	The parameter...
P0.17	EEPROM save mode selection		0	1	0		Bit	0033	0033	The parameter...
P0.18	Production reset		0	1	0		Bit	0034	0034	Set the param...
P0.19	Public control selection		0	1	0		Bit	0035	0035	The parameter...
P0.20	Public control selection		0	1	0		Bit	0036	0036	The parameter...
P0.21	Public control selection		0	1	0		Bit	0037	0037	The parameter...
P0.22	Public control selection		0	1	0		Bit	0038	0038	The parameter...
P0.23	Public control selection		0	1	0		Bit	0039	0039	The parameter...
P0.24	Public control selection		0	1	0		Bit	0040	0040	The direction...
P0.25	Number of the 1st electronic...		1	1	1		Bit	0041	0041	Set the limit...
P0.26	Number of the deceleration gear		1	1	1		Bit	0042	0042	Set the limit...
P0.27	Number of the 2nd electronic...		1	1	1		Bit	0043	0043	Set the limit...
P0.28	Number of the 3rd electronic...		1	1	1		Bit	0044	0044	Set the limit...
P0.29	Number of the 4th electronic...		1	1	1		Bit	0045	0045	Set the limit...
P0.30	Power control IPI time	ms	1000	100	10000	1	Bit	0046	0046	Set the limit...
P0.31	Power control IPI time	ms	1000	100	10000	1	Bit	0047	0047	Set the limit...
P0.32	Power control IPI time	ms	1000	100	10000	1	Bit	0048	0048	Set the limit...
P0.33	Power control IPI time	ms	1000	100	10000	1	Bit	0049	0049	Set the limit...
P0.34	Power control IPI time	ms	1000	100	10000	1	Bit	0050	0050	Set the limit...
P0.35	Power control IPI time	ms	1000	100	10000	1	Bit	0051	0051	Set the limit...
P0.36	Negative position software limit		0	1	0		Bit	0052	0052	Set the limit...
P0.37	Positive control mode selection		0	1	0		Bit	0053	0053	Set the mode...
P0.38	Full speed response		0	1	0		Bit	0054	0054	Set the mode...
P0.39	Speed command selection		0	1	0		Bit	0055	0055	The parameter...

- Axis unit conversions, clear and concise

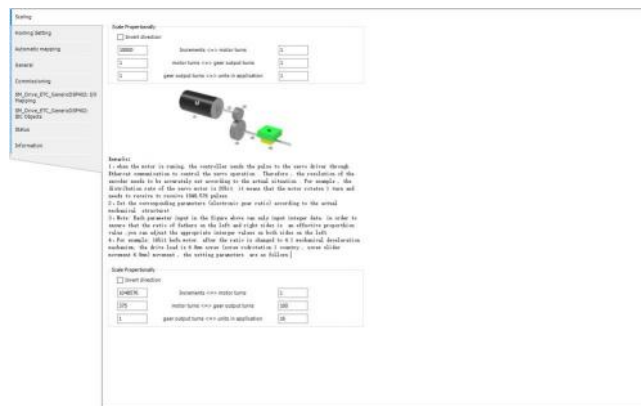

- Homing method, easy to understand

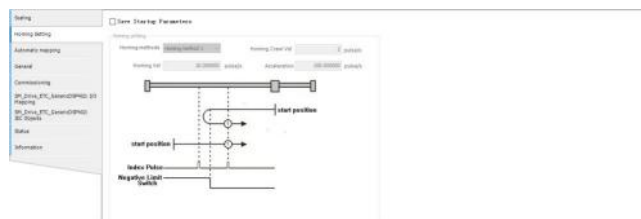

Small PLC

Medium PLC

X86 Controller

I/O System

HMI

Industrial Internet

Technical specifications

Model	TM750	TM751	TM752	TM753
Rated working voltage	DC24V(-15%~+20%)			
Memory				
Program capacity	20MB			
Data capacity	64MB			
Capacity of data saved at power failure	1MB			
Max. capacity of SD card	32G			
I/O				
High-speed I/O	8 high-speed inputs and 8 high-speed outputs			
Max. number of local expansion modules	16			
Max. number of I/O points	Local	512		
	EtherCAT bus	32000		
High-speed input	4 channels of high-speed counter, supporting 1PH, A/B phase, CW/CCW, and pulse+direction, in which A/B phase supports frequency multiplication by 1, 2, and 4			
High-speed output	8 channels of 200kHz high-speed output, supporting 4-axis pulse motion control			
Support for I/O interruption	8 channels of high-speed interrupt input			
PWM output	4 channels of PWM output			
Communication network and interface				
Ethernet	×2, RJ45, 100Base-TX, supporting PLC software download, ModbusTCP, TCP/IP, and OPC UA protocols			
EtherCAT	1×RJ45, 100Base-TX, with the distance between two slave nodes less than 100m			
Serial communication (RS485)	×2, Modbus RTU primary and secondary nodes, in-line terminal			
USB	×1, Type-C, for PC communication, program download and debugging			
Storage card	1×Micro SD, for firmware upgrade, application and file transmission			
Communication expansion	CANopen			
Motion control				
Max. number of control axes	4 axes(EtherCAT)+4 axes(pulse)	8 axes(EtherCAT)+4 axes(pulse)	16 axes(EtherCAT)+4 axes(pulse)	32 axes(EtherCAT)+4 axes(pulse)
Motion control function	Point-to-point (PTP) motion, interpolation motion (linear, arc), electronic gear, electronic cam (flying shear, linear flying shear), and so on			
Configuration programming				
Programming platform	Invtmatic Studio 1.3.5 and above			
Programming languages	IL、ST、FBD、LD、CFC、SFC			
Basic specifications				
Running environment temperature	-10~55°C			
Running environment humidity	10%~95% (no condensation)			
Storage temperature	-40~70°C			
Storage humidity	10%~100% (no condensation)			
IP rating	IP20			
Application environment	No corrosive gas			
Altitude	2000m or lower			
Installation manner	In control cabinet			
Pollution degree	Degree 2 or lower, compliant with IEC 61131-2			
Surge	2kV			
Anti-interference	2kV voltage-withstand power cable (compliant with IEC61000-4-4)			
ESD class	6kV CD or 8kV AD			
Vibration resistant	5~8.5Hz, vibration amplitude of 3.5mm; 8.5~150Hz, acceleration of 10m/s ² ; X/Y/Z axis, 10cycles			
Dimensions and weight				
Dimensions (W×H×D)	80.5×105×96mm (without terminal)		80.5×105×114.2mm (with terminal)	
Weight (kg)	0.39			

EC-CAN product image



Model	EC-CAN
Product description	TS/TM series CAN expansion card, with two RJ45 interfaces and one MicroSD card interface (Only the TS series can use the SD card)
Ingress protection (IP) rating	Ip20
Working temperature	-20°C~55°C
Terminal resistor	Built-in terminal resistor, which can be selected through the dial switch
Baud rate	1Mbps: Distance<20m 500Kbps: Distance<80m 250Kbps: Distance<150m 125Kbps: Distance<300m 100Kbps: Distance<500m 50Kbps: Distance<1000m
SD card capacity	Up to 32GB
SD card specifications	Micro SD
SD card communication interface	SDIO
Hot swapping	Supported by SD cards, but not supported by the expansion card



Model	EC-2AD2DA
Product description	TS/TM series analog expansion card, with 2-channel analog input and 2-channel analog output
Hot swapping	Not supported
Number of input channels	2 channels
Voltage input range	0-10V, 0-5V, and 1-5V
Current input range	0-20mA and 4-20mA
Input accuracy (at room temperature of 25°C)	Voltage±1% Current±1%
Input accuracy (in full temperature range)	Voltage±3% Current±3%
Input resolution	12-bit
Digital input	0-20000
Number of output channels	2 channels
Output voltage range	0-10V, 0-5V, and 1-5V
Output current range	0-20mA and 4-20mA
Output Accuracy (at room temperature of 25°C)	±1%
Output accuracy (in full temperature range)	±5%
Output resolution	12-bit
Digital output	0-20000

Product dimensions

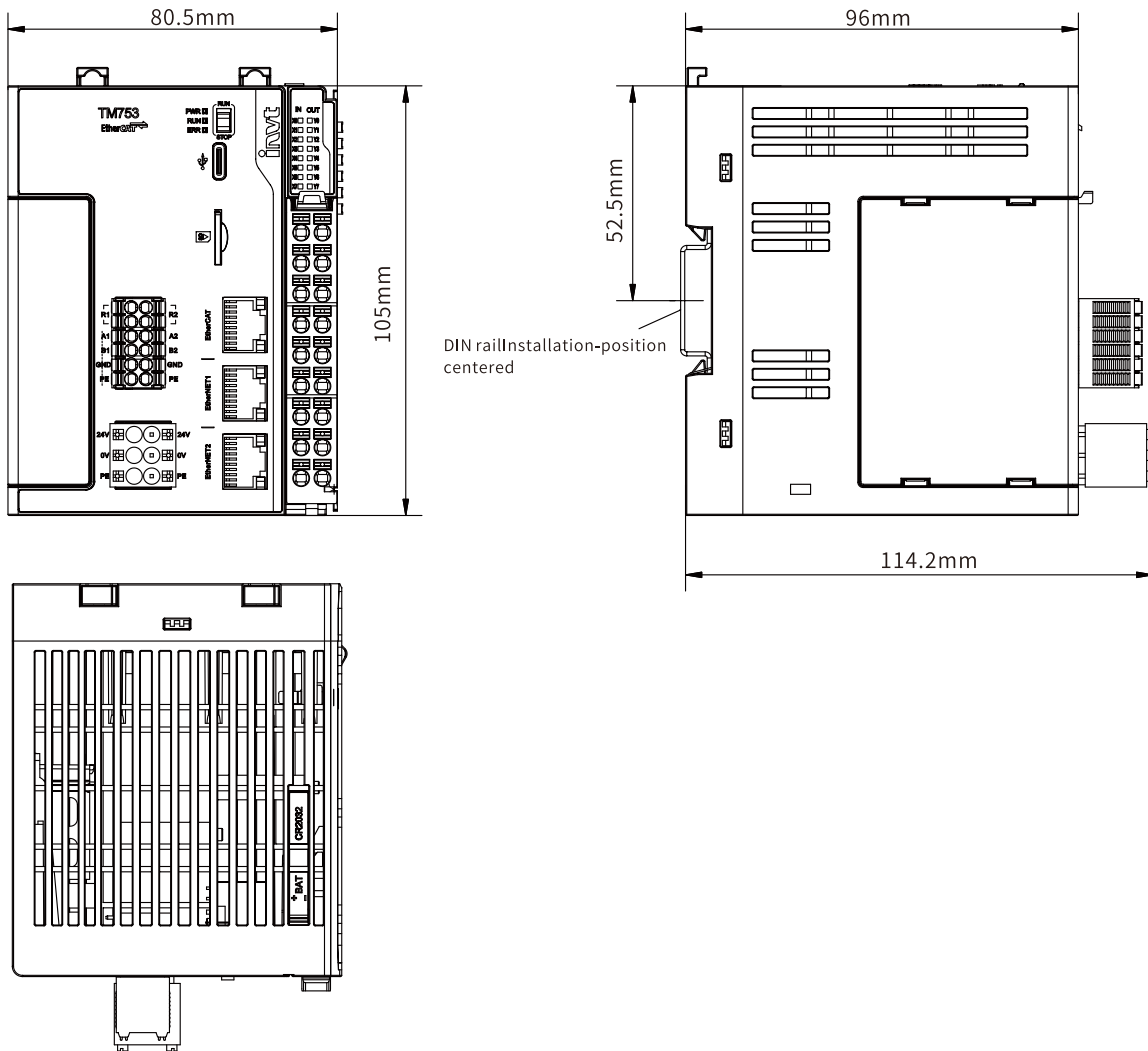

Product list

Ordering code	Model	Description	Dimension
11015-00024	TM750	CPU, 4-axis, 1×EtherCAT, 2×Ethernet, 2×RS485, 8-in and 8-out high-speed I/O, 24VDC; RoHS	80.5×105×114.2mm
11015-00025	TM751	CPU, 8-axis, 1×EtherCAT, 2×Ethernet, 2×RS485, 8-in and 8-out high-speed I/O, 24VDC; RoHS	80.5×105×114.2mm
11015-00026	TM752	CPU, 16-axis, 1×EtherCAT, 2×Ethernet, 2×RS485, 8-in and 8-out high-speed I/O, 24VDC; RoHS	80.5×105×114.2mm
11015-00023	TM753	CPU, 32-axis, 1×EtherCAT, 2×Ethernet, 2×RS485, 8-in and 8-out high-speed I/O, 24VDC; RoHS	80.5×105×114.2mm
11060-00332	EC-CAN	TS/TM series CAN expansion card, with two RJ45 interfaces and one MicroSD card interface (SD card interface only supports TS series)	70.8×20×53.5mm
11060-00333	EC-2AD2DA	TS/TM series analog expansion card, with 2-channel analog input and 2-channel analog output	70.8×20×53.5mm

X86 Controller

Industrial controller based on PC_Based and CODESYS

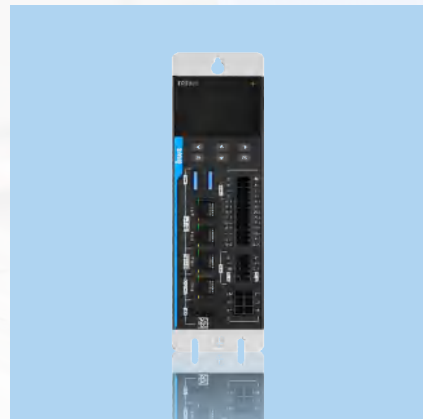

TP2000 SERIES

The TP2000 series intelligent controller is a high-performance and production-line-level controller based on the x86 hardware platform and fully compliant with the PLCopen standard. Supporting up to 128 axes, it delivers powerful performance and flexible networking, enabling complex multi-axis motion control and large-scale logic control with ease. It is well suited for both discrete and process automation applications. It can be widely used in industries such as printing, packaging, food, lithium battery, 3C, photovoltaic, woodworking, small to medium-sized production lines, and process control.



Powerful performance

500µs @ 32 axes high-speed response, with bus synchronization control for up to 128 axes, achieving higher precision and shorter processing cycle. o medium-sized production lines, and process control.



Seamless connectivity

Supports industrial protocols such as EtherCAT, OPC UA, and EtherNet/IP, enabling seamless integration with mainstream devices and breaking down brand barriers.



Dual-domain architecture

Physically isolated dual master stations for high and low real-time task domain processing, ensuring no interference and maximizing hardware performance.



Ring network redundancy

In the event of a single node cable failure, the system can continue running without downtime, enhancing system stability and reducing downtime losses.



Advanced motion control

Functions such as Buffermode, G-code, and robotic arms enable multi-scenario integration.



Information visualization

TargetVisu, web-based visualization, and onboard color screens allow real-time access to device information.



*Expected to be officially launched in Q4 2025

Powerful performance

- Minimum 250µs @ 16-axis synchronization cycle, 500µs @ 32-axis motion control, jitter<20µs, ensuring stability and precision.
- Supports up to 128 axes bus control, capable of handling complex devices with ease
- Supports 125 I/O slaves, with logic control capacity up to 128,000 points

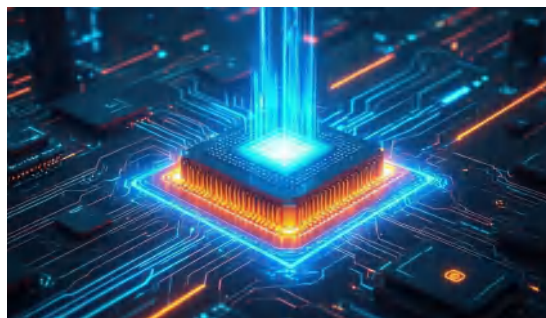

Seamless connectivity

- Supports a wide range of interfaces and protocols including EtherCAT, OPC UA, EtherNet/IP, Profinet (PN) master, Modbus TCP, TCP/IP, UDP, and Modbus RTU, enabling seamless integration with third-party devices.
- The Ethernet interface comes with an independent IP by default, ensuring data isolation and safe operation.
- The Ethernet interface supports the soft switch function, simplifying system configuration and offering flexibility and convenience.

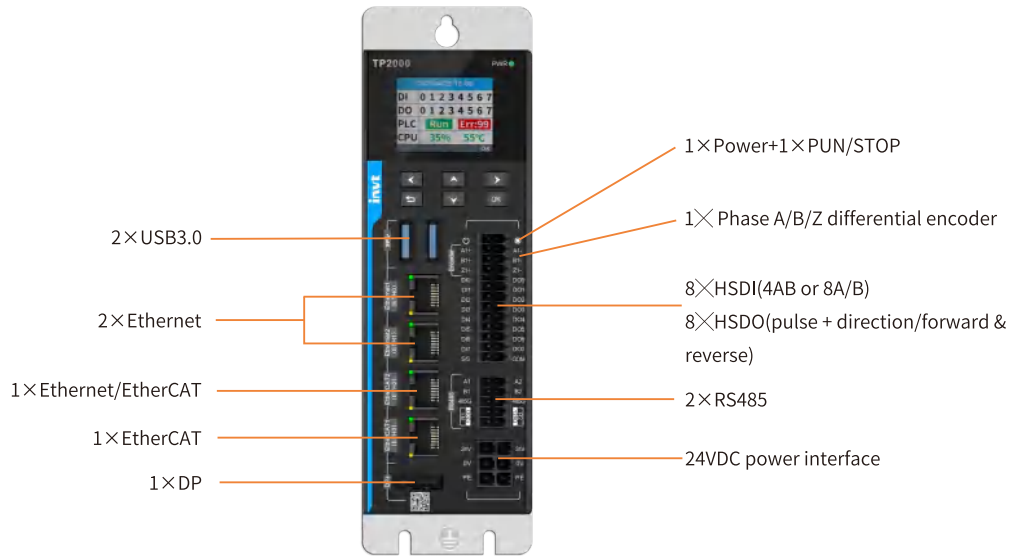

Dual-domain architecture

- Physically isolated dual master stations, with high and low real-time task domain processing, maximizing hardware performance.
- Cost-effective integration. One unit replaces two traditional PLCs, reducing hardware costs by 50% and eliminating communication delays between PLCs.
- Fault isolation. Automatic isolation of faults within a single domain, preventing system-wide failure.

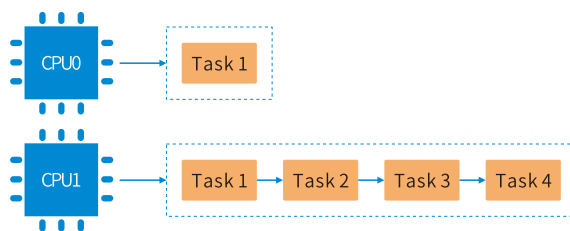

Cable redundancy

- In the event of a single node cable failure, the system can continue running without downtime, enhancing system stability and reducing downtime losses.

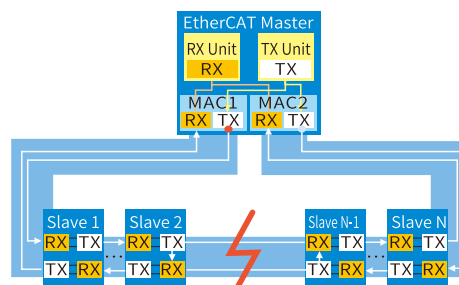

Advanced motion control

- Functions such as Buffermode, G-code, and robotic arms enable multi-scenario and multi-station production line-level integration.

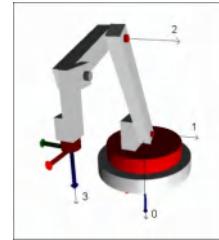
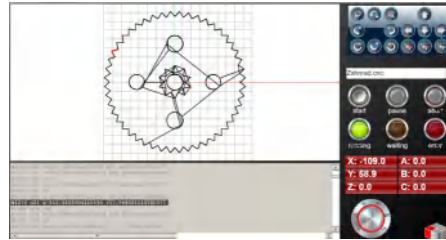
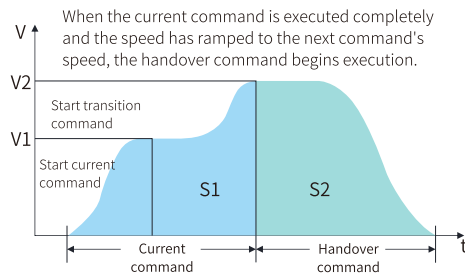

Efficient visualization

- Running status, basic information, and alarm data are displayed intuitively for easy access.
- TargetVisu requires no third-party configuration software, allowing direct access to program variables, real-time simulation, and making application development more efficient and convenient.
- The web-based visualization function enables multi-terminal and distributed access within a local network, making system monitoring and adjustments more efficient and convenient.

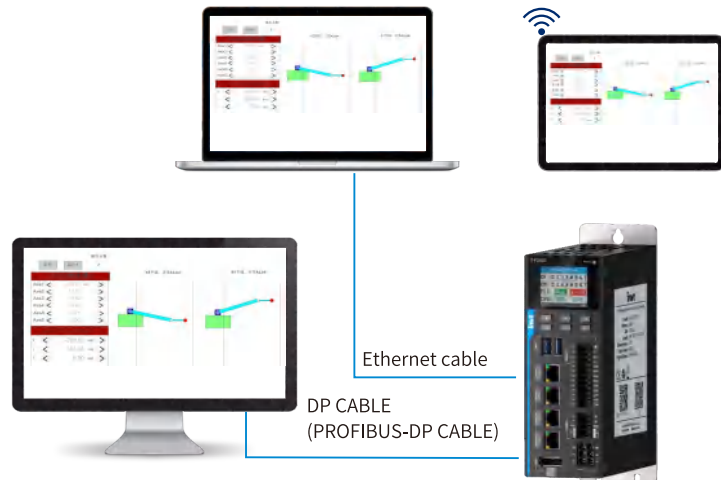

Efficient commissioning

- Integrated servo and VFD function codes for parameter commissioning, with one-click import/export.
- EOE direct connection. PC-side servo/VFD commissioning software can directly access servos/VFDs in the EtherCAT network via their IP address, offering more comprehensive functions and significantly improving commissioning and maintenance efficiency.

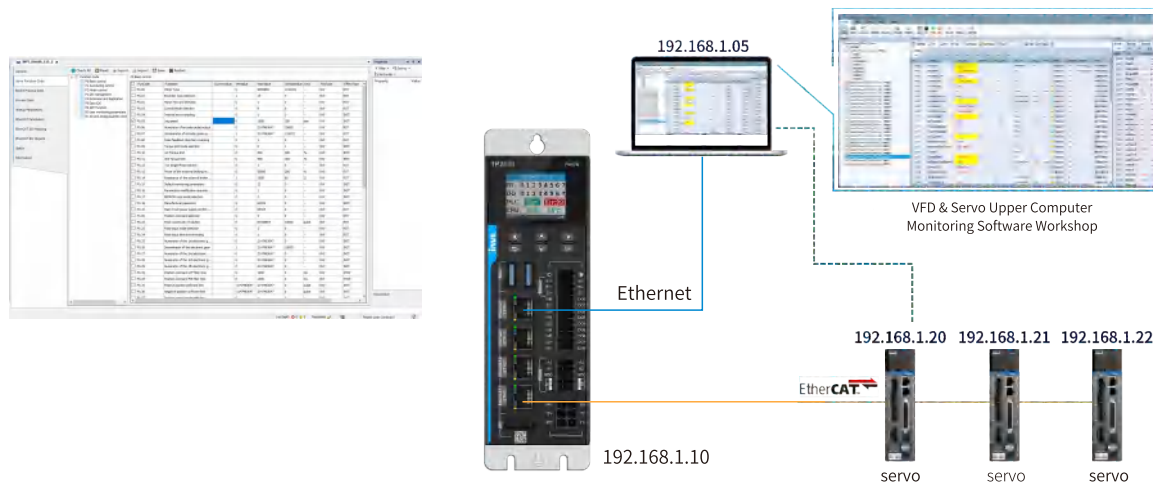

Large-scale distributed I/O

- Supports up to 125 I/O slaves and is equipped with the Flex series I/O system, enabling large-scale I/O control with up to 128,000 points.



Built-in UPS

- The built-in UPS offers a 1-second power transition, eliminating the need for an external UPS. It ensures 5MB of large-capacity power backup during a power failure, simplifying setup, saving space, and reducing overall system costs.



Specifications

codecode	11015-00043	11015-00042	11015-00045	11015-00032	11015-00044	11015-00046
Model	TP2321-1016	TP2321-1032	TP2422-1048	TP2422-1064	TP2422-1096	TP2422-1128
Rated operating voltage	24VDC (-20%~+20%)					
Processor	Dual-core			Quad-core		
Memory				8GB DDR4		
Hard disk	64GB SSD			128GB SSD		
User program capacity				256MB		
User data capacity				256MB		
Power-down data retention capacity				5MB		
Display screen				LCD		
System clock	Users need to purchase the button battery (Model: Cr2032)					
Communication network and interfaces						
Ethernet	3×RJ45 interfaces with 100/1000Base-TX, and independent IP, supporting switch and protocols such as OPC UA, EtherNet/IP, Modbus TCP, and UDP		2×RJ45 interfaces with 100/1000Base-TX, and independent IP, supporting switch and protocols such as OPC UA, EtherNet/IP, Modbus TCP, and UDP			
EtherCAT	1×RJ45 interface with 100/1000Base-TX 1×EtherCAT master		2×RJ45 interfaces with 100/1000Base-TX 2×EtherCAT master			
USB	2×USB 3.0, Type-A					
Serial communication	2×RS485, in-line terminals , supporting Modbus RTU protocol					
Display interface	1×DP					

Specifications

codecode	11015-00043	11015-00042	11015-00045	11015-00032	11015-00044	11015-00046
Model	TP2321-1016	TP2321-1032	TP2422-1048	TP2422-1064	TP2422-1096	TP2422-1128
I/O						
Inputs	Single-ended (Sourcing/Sinking): 8 channels, supporting 4-channel AB-phase encoder input, can be used as general inputs					
Outputs	Single-ended (Sinking): 8 channels, supporting 4-channel pulse output, can be used as general outputs					
Remote I/O points	128,000 points (EtherCAT bus)					
Motion Control						
Maximum number of controlled axes	16 axes	32 axes	48 axes	64 axes	96 axes	128 axes
Point-to-point control				●		
Interpolation motion				●		
Electronic cam				●		
Electronic gear				●		
CNC				●		
ROBOT				●		
Motion control cycle	The EtherCAT data communication cycle uses the same control cycle					
Position units	Pulse count, millimeters, and inches					
Redundancy						
Cable Redundancy	—	—	●	●	●	●
Configuration programming						
Programming platform	Invtmatic Studio 3.0 .0.7and later					
Programming language	IL, ST, FBD, LD, CFC, and SFC					
Basic specifications						
Installation position	Inside the control cabinet					
Ingress protection (IP) rating	Ip20					
Working environment temperature	-10°C~+55°C					
Working environment relative humidity (RH)	10%~95% (No condensation)					
Storage temperature	-40°C~+70°C					
Storage humidity	10%~100% (No condensation)					
Atmosphere	No corrosive gas					
Altitude	2000m					
Pollution degree	Degree 2 or below: Compliant with IEC 61800-61131-2					
Surge Level	2kV for power line, compliant with IEC 61000-4-4 standard					
Electrostatic discharge level	4kV CD and 6kV AD					
Impact resistance	5~8.5Hz with an amplitude of 3.5 mm; 8.5~150Hz with an acceleration of 10 m/s ² ; tested on the X, Y, and Z axes for 10 cycles					
Dimensions and weight						
Weight (kg)	Product weight: 1.41; Packaging weight: 1.59					
Dimensions W×H×D (mm)	Product dimensions: 60×195×158.3; Packaging dimensions: 108×255×198					

TP2000 Product List

Ordering code	Model	Description	Dimensions W x H x D (mm)
11015-00043	TP2321-1016	IPC; 1 × EtherCAT master station; 16 axes; 64GB flash storage; 8GB memory; Linux	60×195×158.3
11015-00042	TP2321-1032	IPC; 1 × EtherCAT master station; 32 axes; 64GB flash storage; 8GB memory; Linux	60×195×158.3
11015-00045	TP2422-1048	IPC; 2 × EtherCAT master station; 48 axes; 128GB flash storage; 8GB memory; Linux	60×195×158.3
11015-00032	TP2422-1064	IPC; 2 × EtherCAT master station; 64 axes; 128GB flash storage; 8GB memory; Linux	60×195×158.3
11015-00044	TP2422-1096	IPC; 2 × EtherCAT master station; 96 axes; 128GB flash storage; 8GB memory; Linux	60×195×158.3
11015-00046	TP2422-1128	IPC; 2 × EtherCAT master station; 128 axes; 128GB flash storage; 8GB memory; Linux	60×195×158.3

I/O system

Hundred-megabit rate compatible with various international communication networks



Flex series new generation distributed I/O system

INVT Flex series I/O system is a flexible, reliable, and efficient signal transmission system. The system is able to access to multiple standard communication networks, and equipped with rich signal modules to facilitate the deployment of personalized solutions while saving cabinet space, helping you develop more competitive personalized solutions.

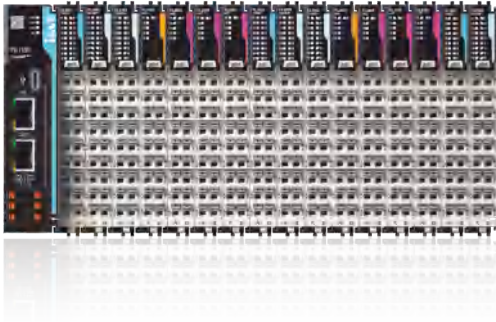

Flexible

Rich communication couplers and I/O modules enable the exible design of control systems.



Efficient

Fully upgraded F-BUS bus with a 100-megabit communication rate creates a high real-time communication system.



Reliable

Tight connection using the gold plating process ensures stable and reliable signal transmission.



Compact

Ultra-thin design significantly saves cabinet space and helps the equipment layout miniaturization.

Flexible

The open Flex series I/O system adopts a modular design, supporting various bus network, and is equipped with rich signal modules to create personalized solutions. By importing the device description le to a third-party host controller, the module conguration can be achieved without specialized software conguration.

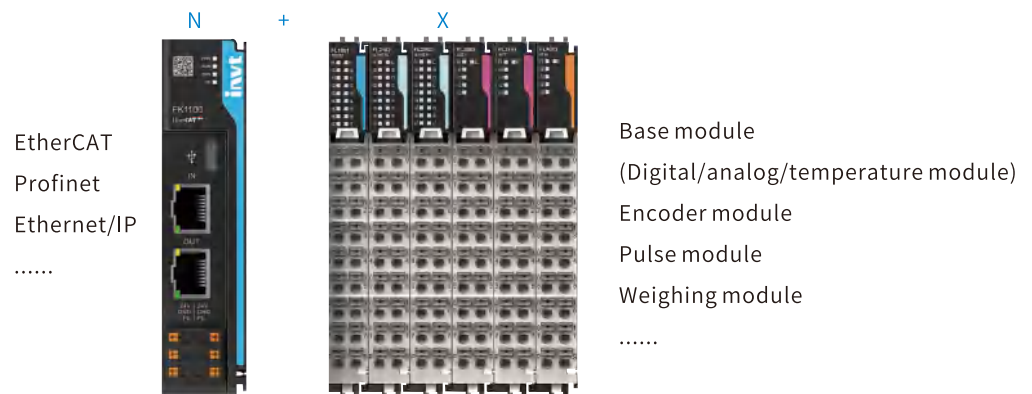

Efficient

The system is equipped with a 100Mbps F-BUS backplane bus, with a response of I/O refresh in microseconds, achieving high-speed information exchange.

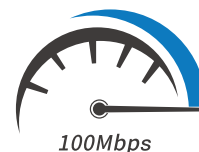

Product positioning

Spring-loaded connection technology and 5u" gold plating process keep the connectors away from various types of corrosion and ensure a long service life of connectors.



The entire series adopts three-resistance coating to prevent dust, moisture, and salt spray, meeting a wider range of operating conditions and extending service life.



Reliable grounding, further enhancing anti-interference capability.

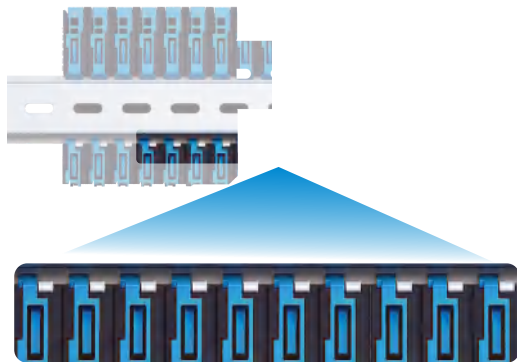

Capable of operating in -25~55°C and at an altitude of 3000m, fearless of freezing weather.



Compact

12mm ultra-thin design, saving 64% of the cabinet space, achieving miniaturization of the cabinet.



Easy installation

The wiring diagram is printed on the module so the wiring can be completed without referencing a user manual. By scanning the QR code on the front, you can obtain an electronic version of the user manual for more information.



Tool-free quick connection

PUSH IN connection technology enables easy installation without any tools, with a 70% improvement in wiring efficiency compared to screw terminals, effectively reducing installation time while ensuring good reliability.

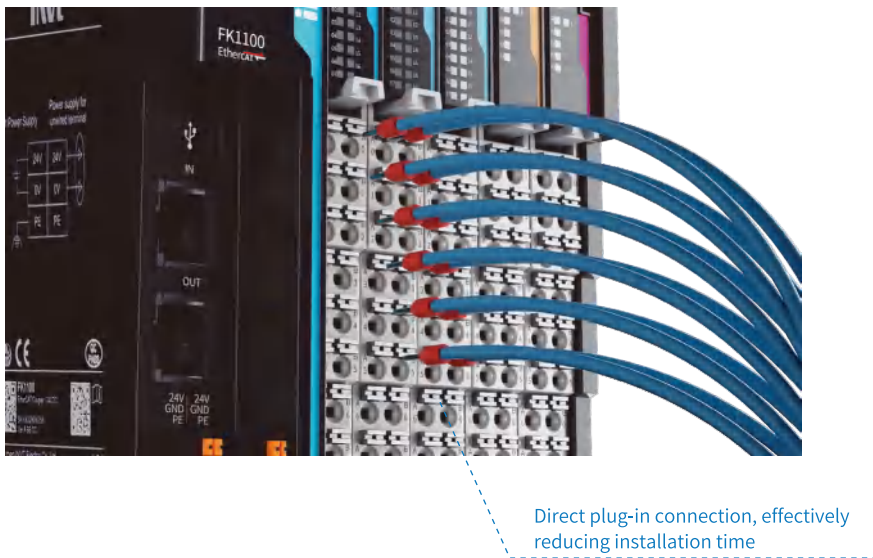

Clear identification

▣ Different modules are distinguished by color blocks and auxiliary codes, making identification and positioning more accurate and convenient.

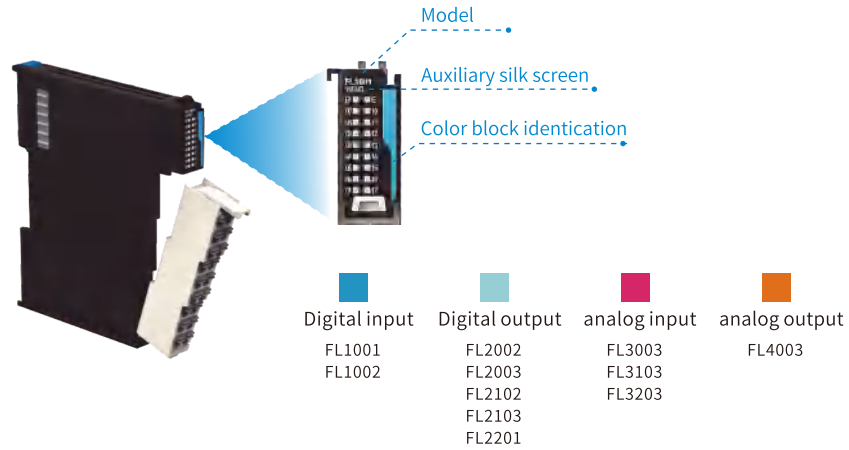

Channel-level diagnosis

▣ Each channel has a status indicator light, and each module can independently display its working status. The operating status and fault information are clear at a glance.

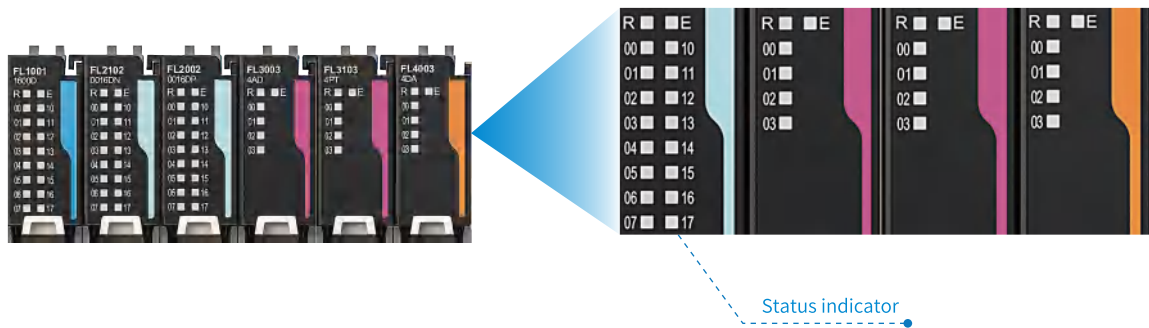

Easy to maintain

▣ Longitudinal sliding connection allows terminal assembly and disassembly without moving the left and right modules. Adopting a two-section modular design, the wiring terminals can be disassembled separately without repeated wiring.

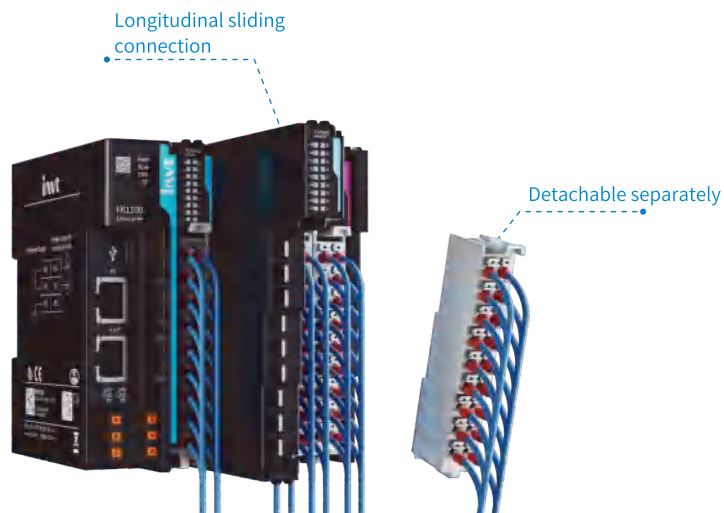

• Communication coupler (EtherCAT)

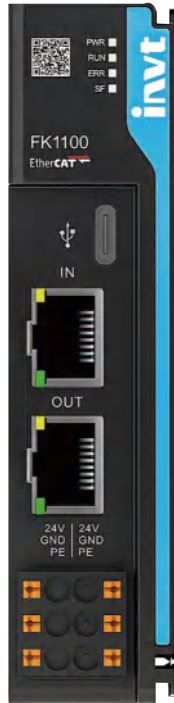

Item	Specifications			
Ordering code	11016-00005			
Model	FK1100			
Product type	EtherCAT communication coupler			
Power supply	Rated voltage	24VDC (-15%~ +20%)		
	Power consumption of module	<10W		
	Isolation	No isolation		
	Power supply protection	Protection against reverse connection, overcurrent, and surges		
Interface	USB2.0	×1, for module upgrade		
	RJ45	×2, EtherCAT IN&OUT		
	EtherCAT slave	Synchronization method	Distributed clocks or input and output synchronization	
		Physical layer	100BASE-TX	
		Baud rate	100Mbit/s	
		Output distance	Less than 100m between two nodes	
		Transmission mode	Full duplex	
		Topology structure	Linear, star-shape, tree-shape	
		Slave address range	Assigned by the system	
		Quantity of input PDO	Up to 768 bytes	
		Quantity of output PDO	Up to 768 bytes	
		Input mailbox size	Up to 128 bytes	
	Output mailbox size	Up to 128 bytes		
	Expansion bus	Number of I/O expansions	16, internal bus. The coupler can automatically identify the I/O type and quantity on the backplane	
Output power supply		5V/2.5A		
Certification	CE, RoHS			
Environment	IP rating	IP20		
	Working temperature	-20°C~55°C		
	Working humidity	10%~95%RH (no condensation)		
	Air	No corrosive gas		
	Storage temperature	-40°C~70°C (RH<90%RH, no condensation)		
	Altitude	Lower than 3000m		
	Pollution degree	Degree 2, compliant with IEC61131-2		
	Anti-interference	2kV power cable compliant with IEC61000-4-4		
	EMC antiinterference level	Zone B, IEC61131-2 (General industrial environment)		
	Vibration resistant	IEC60068-2-6 5Hz~8.4Hz, vibration amplitude of 3.5mm, 8.4Hz~150Hz, acceleration 9.8m/s ² , 100 minutes for each in X, Y, and Z directions (10 times, 10 minutes each time, a total of 100 minutes)		
Impact resistance	IEC60068-2-27, 9.8m/s ² , 11ms, X/Y/Z, 3 times for each of 3 axes and 6 directions			
Installation method	35mm standard rail			
Weight	Net: 0.25(Kg)	Gross: 0.28(Kg)		
Dimensions W×H×D	Product dimension: 25×105×96(mm)			
	Package dimension: 29×109×100(mm)			

● Communication coupler (Profinet)

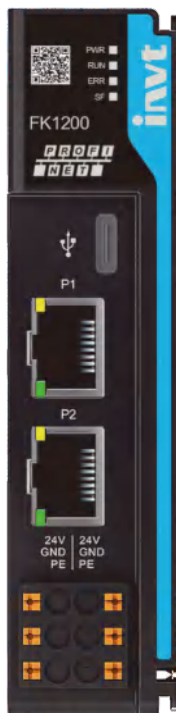

Item	Specifications		
Ordering code	11016-00012		
Model	FK1200		
Product type	PROFINET communication coupler		
Power supply	Rated voltage	24VDC (-15% ~ +20%)	
	Power consumption of module	<10W	
	Power supply protection	Protection against reverse connection, overcurrent, and surges	
Interface	Isolation	No isolation	
	USB2.0	×1, for module upgrade	
		RJ45	×2, Profinet P1&P2
	Profinet	Physical layer	100BASE-TX
		Baud rate	100Mbit/s
		Output distance	Less than 100m between two nodes
		Transmission mode	Full duplex
		Topology structure	Linear, star-shape, tree-shape
		Communication protocol	Profinet IO Device
		Communication mode	RT
		Communication period	Min. 1ms
		Process data zone	Input max. 1440 bytes, output max. 1440bytes; IM0-IM3
		Pronet switch function	Supports networking function
	Ethernet service	Supports TCP/IP, SNMP, LLDP, ping, arp	
	Port diagnosis	Supported	
	Port disabling	Supported	
	Factory settings reset	Supported	
Expansion bus	Number of I/O expansions	16, internal bus. The coupler can automatically identify the I/O type and quantity on the backplane	
	Output power supply	5V/2.5A	
Certification	CE, RoHS		
Environment	IP rating	IP20	
	Working temperature	-25°C~55°C	
	Working humidity	10%~95%RH (no condensation)	
	Air	No corrosive gas	
	Storage temperature	-40°C~70°C (RH<90%RH, no condensation)	
	Altitude	Lower than 3000m	
	Pollution degree	Degree 2, compliant with IEC61131-2	
	Anti-interference	2kV power cable compliant with IEC61000-4-4	
	EMC antiinterference level	Zone B, IEC61131-2 (General industrial environment)	
Vibration resistant	IEC60068-2-6 5Hz~8.4Hz, vibration amplitude of 3.5mm, 8.4Hz~150Hz, acceleration 9.8m/s ² , 100 minutes for each in X, Y, and Z directions (10 times, 10 minutes each time, a total of 100 minutes)		
Impact resistance	IEC60068-2-27, 9.8m/s ² , 11ms, X/Y/Z, 3 times for each of 3 axes and 6 directions		
Installation method	35mm standard rail		
Weight	Net: 0.25(Kg) Gross: 0.28(Kg)		
Dimensions W×H×D	Product dimension: 25×105×96(mm)		
	Package dimension: 29×109×100(mm)		

Small PLC

Medium PLC

X86 Controller

I/O System

HMI

Industrial Internet

• Communication coupler (EtherNet/IP)

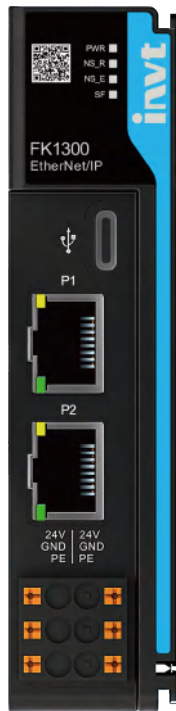

Item	Specifications			
Ordering code	11016-00018			
Model	FK1300			
Product type	EtherNet/IP communication coupler			
Power supply	Rated voltage	24VDC (-15%~ +20%)		
	Power consumption of module	<10W		
	Isolation	No isolation		
	Power supply protection	Protection against reverse connection, overcurrent, and surges		
Interface	USB2.0	×1, used for module upgrade		
	RJ45	×2, EtherNet/IP P1&P2		
	EtherNet/IP	Physical layer	100BASE-TX	
		Baud rate	100Mbit/s	
		Output distance	Less than 100m between two nodes	
		Transmission mode	Full duplex	
		Topology structure	Linear, star, or tree	
		Communication protocol	EtherNet/IP	
		Max input length	504 bytes	
		Max output length	504 bytes	
		Max number of explicit message connections	6	
		Max number of implicit message connections	3	
	Max number of CIP connections	6		
	Min. request packet interval (RPI)	1ms		
	Alarm/Diagnosis status information	Supporting the upload of function codes from the local to the PLC		
Expansion bus	Number of I/O expansions	Up to 16, which depends on the actual power consumption calculation		
	Output power supply	5V/2.5A		
Certification	CE, RoHS			
Environment	IP rating	IP20		
	Working temperature	-20°C~55°C		
	Working humidity	10%~95%RH (no condensation)		
	Air	No corrosive gas		
	Storage temperature	-40°C~70°C (RH<90%RH, no condensation)		
	Altitude	Lower than 3000m		
	Pollution degree	Degree 2, compliant with IEC61131-2		
	Anti-interference	2kV power cable compliant with IEC61000-4-4		
EMC antiinterference level	Zone B, IEC61131-2 (General industrial environment)			
	Vibration resistant	IEC60068-2-6 5Hz~8.4Hz, vibration amplitude of 3.5mm, 8.4Hz~150Hz, acceleration 9.8m/s ² , 100 minutes for each in X, Y, and Z directions (10 times, 10 minutes each time, a total of 100 minutes)		
		Impact resistance	IEC60068-2-27, 9.8m/s ² , 11ms, X/Y/Z, 3 times for each of 3 axes and 6 directions	
Installation method	35mm standard rail			
Weight	Net: 0.25(Kg)	Gross: 0.28(Kg)		
Dimensions W×H×D	Product dimension: 25×105×96(mm)			
	Package dimension: 29×109×100(mm)			

● Communication coupler (Modbus TCP)

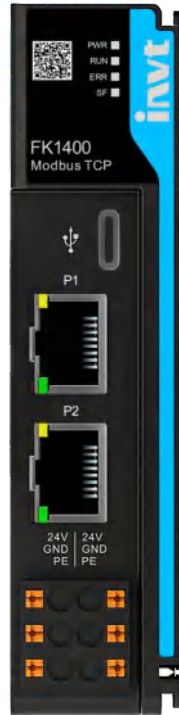

Item	Specifications		
Ordering code	11016-00029		
Model	FK1400		
Product type	Modbus TCP communication coupler		
Power supply	Rated voltage	24VDC (-15%~ +20%)	
	Power consumption of module	<10W	
	Isolation	No isolation	
Interface	Power supply protection	Protection against reverse connection, overcurrent, and surges	
	USB2.0	×1, used for module upgrade	
	RJ45	×2, Modbus TCP	
	Modbus TCP server (slave)	Max. number of client connections	5
		TCP keepalive timer	Supported
		Watchdog setting	Supported (on by default, 30s)
		Supported function codes	01/02/03/04/05/06/15/16/23
		IP address setting	Using the Ttools-IO tool
		Diagnostic function	Supported
		Physical layer	100BASE-TX
		Communication rate	10M/100Mbps, adaptive
		Communication method	Full duplex
		Topology structure	Linear, star, tree
	Transmission medium	Category-5 or higher network cables	
	Transmission distance	Max. segment length: 100m	
Alarm/Diagnosis status information	Supporting the upload of function codes from the local to the PLC		
Expansion bus	Scalable I/O count	Up to 32, must be used with power feed modules. The actual number depends on power consumption	
	Output power supply	5V/2.5A(12.5W)	
Certification	CE, RoHS		
Environment	IP rating	IP20	
	Working temperature	-20°C~55°C	
	Working humidity	10%~95%RH (no condensation)	
	Air	No corrosive gas	
	Storage temperature	-40°C~70°C (RH<90%RH, no condensation)	
	Altitude	Below 3000m	
	Pollution degree	Degree 2 or lower, compliant with IEC61131-2	
	Immunity standard	2kV power cable, compliant with IEC61000-4-4	
	EMC standard	Zone B, IEC61131-2 (general industrial environment)	
Vibration resistance standard	IEC60068-2-6		
Impact test	IEC60068-2-27, 9.8m/s ² , 11ms, X/Y/Z, 3 axes in 6 directions repeated 3 times		
Installation method	35mm standard rail		
Weight	Net: 0.25(Kg) Gross: 0.28(Kg)		
Dimensions W×H×D	Product dimension: 25×105×96(mm)		
	Package dimension: 29×109×100(mm)		

Small PLC

Medium PLC

X86 Controller

I/O System

HMI

Industrial Internet

• Digital input

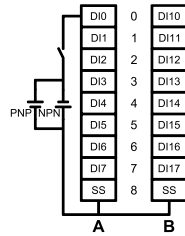

Model	FL1001
Ordering code	11016-00004
Product type	Digital input, supporting source type/sink type
Power loss	0.71W
Number of channels	16
Input type	Source/sink
Input voltage	DC24V±10%
Input current	7mA
Max. input frequency	500Hz (duty ratio: 40%-60%)
Port filter time	Setting range: 1-65535 (default 1000), unit: 10µs; 1000 indicates 10ms. Able to set two groups of lter parameter. Every eight channels use a group of lter parameter
Signal of logic 1	≥15V DC
Signal of logic 0	≤5V DC
OFF-ON response time	100µs
ON-OFF response time	100µs
Isolation method	Optocoupler
Input frequency decrease	Derate by 75% when operating at 55°C (with no more than 12 input points that are on at the same time), or by 10°C when all input points are on
Weight	Net: 0.15(Kg) Gross: 0.18(Kg)
Dimensions (W×H×D)	Product dimension: 12.5×105×96mm Package dimension: 17.5×109×100mm

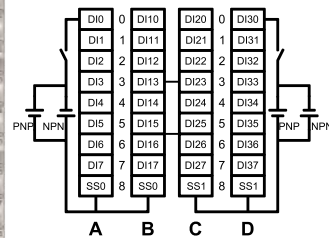

Model	FL1002
Ordering code	11016-00016
Product type	Digital input, supporting source type/sink type
Power loss	0.73W
Number of channels	32
Input type	Source/sink
Input voltage	DC24V±10%
Input current	7mA
Max. input frequency	500Hz (duty ratio: 40%-60%)
Port filter time	Setting range: 1-65535 (default 1000), unit: 10µs; 1000 indicates 10ms. Able to set two groups of lter parameter. Every eight channels use a group of lter parameter.
Signal of logic 1	≥15V DC
Signal of logic 0	≤5V DC
OFF-ON response time	100µs
ON-OFF response time	100µs
Isolation method	Optocoupler
Input frequency decrease	Derate by 75% when operating at 55°C (with no more than 12 input points that are on at the same time), or by 10°C when all input points are on
Weight	Net: 0.30(Kg) Gross: 0.33(Kg)
Dimensions (W×H×D)	Product dimension: 25×105×96mm Package dimension: 29×109×100mm

● Digital output (source type)

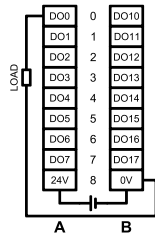

Model	FL2002
Ordering code	11016-00006
Product type	Digital output, transistor source type output, active high
Power loss	0.77W
Number of channels	16
External power	DC24V (-15%~+20%)
Output voltage	24V±10%
Max. output frequency	1kHz
Max. load	Resistive load: 0.5A/point, 2A/module Inductive load: 7.2W/point, 12W/module Illumination load: 5W/point, 18W/module
Leakage current/point	<10uA
OFF-ON response time	100µs
ON-OFF response time	100µs
Protection against overheat/overcurrent/overvoltage	Supported
Exception check of external power	Supported
Isolation method	Magnetic
Short-circuit protection output	Yes
Weight	Net: 0.15(Kg) Gross: 0.18(Kg)
Dimensions (W×H×D)	Product dimension: 12.5×105×96mm Package dimension: 17.5×109×100mm

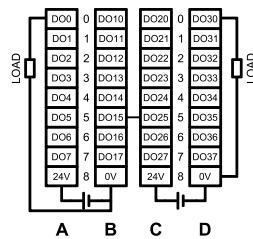

Model	FL2003
Ordering code	11016-00013
Product type	Digital output, transistor source type output, active high
Power loss	0.78W
Number of channels	32
External power	DC24V (-15%~+20%)
Output voltage	24V±10%
Max. output frequency	1kHz
Max. load	Resistive load: 0.5A/point, 2A/module Inductive load: 7.2W/point, 12W/module Illumination load: 5W/point, 18W/module
Leakage current/point	<10uA
OFF-ON response time	100µs
ON-OFF response time	100µs
Protection against overheat/overcurrent/overvoltage	Supported
Exception check of external power	Supported
Isolation method	Optocoupler isolation
Short-circuit protection output	Yes
Weight	Net: 0.30(Kg) Gross: 0.33(Kg)
Dimensions (W×H×D)	Product dimension: 25×105×96mm Package dimension: 29×109×100mm

● Digital output (sink type)

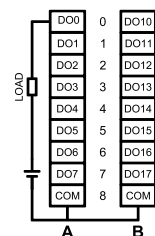

Model	FL2102
Ordering code	11016-00003
Product type	Digital output, transistor sink type output, active low
Power loss	1.04W
Number of channels	16
External power	DC24V (-15%~+20%)
Output voltage	24V±10%
Max. output frequency	1kHz (duty ratio: 40%~60%)
Max. load	Resistive load: 0.5A/point, 4A/module Inductive load: 7.2W/point, 24W/module Illumination load: 5W/point, 18W/module
Leakage current/point	<10uA
OFF-ON response time	100µs
ON-OFF response time	100µs
Protection against overheat/overcurrent/overvoltage	Supported
Exception check of external power	Supported
Isolation method	Magnetic
Short-circuit protection output	Yes
Weight	Net: 0.15(Kg) Gross: 0.18(Kg)
Dimensions (W×H×D)	Product dimension: 12.5×105×96mm Package dimension: 17.5×109×100mm

● Digital output (sink type)

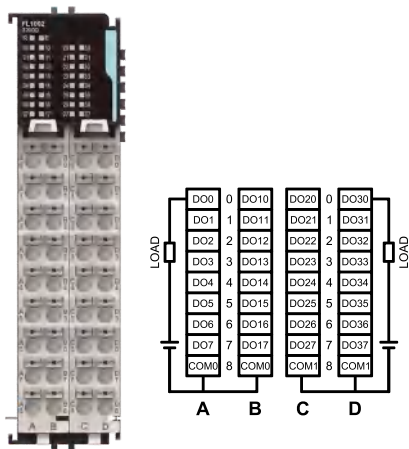

Model	FL2103
Ordering code	11016-00017
Product type	Digital output, transistor sink type output, active low
Power loss	1.46W
Number of channels	32
External power	DC24V (-15%~+20%)
Output voltage	DC24V±10%
Max. output frequency	1kHz (duty ratio: 40%~60%)
Max. load	Resistive load: 0.5A/point, 4A/module Inductive load: 7.2W/point, 24W/module Illumination load: 5W/point, 18W/module
Leakage current/point	<10uA
OFF-ON response time	100μs
ON-OFF response time	100μs
Protection against overheat/overcurrent/overvoltage	Supported
Exception check of external power	Supported
Isolation method	Magnetic
Short-circuit protection output	Yes
Weight	Net: 0.15(Kg) Gross: 0.18(Kg)
Dimensions (W×H×D)	Product dimension: 25×105×96mm Package dimension: 29×109×100mm

● Digital input & output (source type)

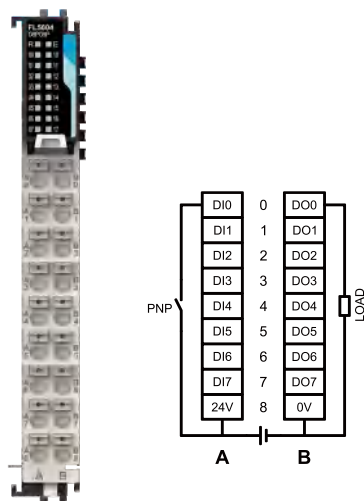

Model	FL5004
Ordering code	11016-00045
Product type	Digital input and output
Power loss, typ.	0.78W
Number of input channels	8
Input type	Source
Input voltage	DC24V±10%
Input current	5.2mA
Port filter time	Setting range: 1~65535 (default 1000), unit: 10μs; 1000 indicates 10ms. Eight channels use a group of filter parameter
Signal of logic 1	≥15V DC
Signal of logic 0	≤5V DC
Isolation method	Optocoupler
Input frequency decrease	Derate by 75% when operating at 55°C (with no more than 4 input points that are on at the same time), or by 10°C when all input points are on
Number of output channels	8
Output type	Transistor, sink type, active high
External power	DC24V(-15%~+20%)
Output voltage	24V±10%
Max. load	Resistive load: 0.5A/point, 2A/module Inductive load: 7.2W/point, 12W/module Illumination load: 5W/point, 9W/module
Leakage current/point	<10uA
Protection against overheat/overcurrent/overvoltage	Supported
Exception check of external power	Supported
Isolation method	Capacitive isolation
Short-circuit protection output	Supported
OFF-ON	300μs
ON-OFF	300μs
Weight	Net: 0.15Kg Gross: 0.18Kg
Dimensions (W×H×D)	Product dimension: 12.5×105×96mm Package dimension: 17.5×109×100mm

● Digital input & output (sink type)

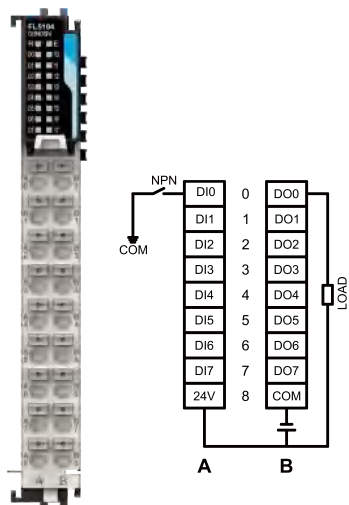

Model	FL5104
Ordering code	11016-00044
Product type	Digital input and output
Power loss, typ.	0.78W
Number of input channels	8
Input type	Sink
Input voltage	DC24V±10%
Input current	5.2mA
Port filter time	Setting range: 1-65535 (default 1000), unit: 10μs; 1000 indicates 10ms. Eight channels use a group of filter parameter
Signal of logic 1	≥15V DC
Signal of logic 0	≤5V DC
Isolation method	Optocoupler
Input frequency decrease	Derate by 75% when operating at 55°C (with no more than 4 input points that are on at the same time), or by 10°C when all input points are on
Number of output channels	8
Output type	Transistor, sink type, active low
External power	DC24V(-15%~+20%)
Output voltage	24V±10%
Max. load	Resistive load: 0.5A/point, 2A/module Inductive load: 7.2W/point, 12W/module Illumination load: 5W/point, 9W/module
Leakage current/point	<10uA
Protection against overheat/overcurrent/overvoltage	Supported
Exception check of external power	Supported
Isolation method	Capacitive isolation
Short-circuit protection output	Supported
OFF-ON	300μs
ON-OFF	300μs
Weight	Net: 0.15Kg Gross: 0.18Kg
Dimensions (W×H×D)	Product dimension: 12.5×105×96mm Package dimension: 17.5×109×100mm

Small PLC

Medium PLC

X86 Controller

I/O System

HMI

Industrial Internet

● Digital input & output (source type)

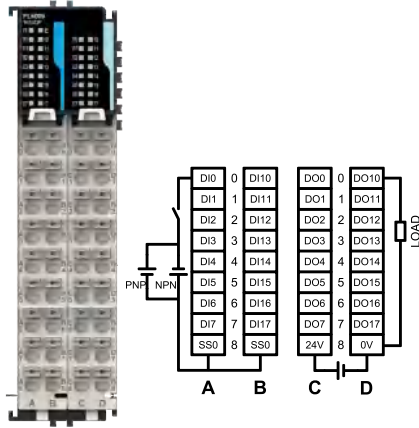

Model	FL5005
Ordering code	11016-00015
Product type	Digital input and output
Power loss	0.68W
Number of channels	16
Input type	Source/sink
Input voltage	DC24V±10%
Input current,typ	7mA
Max. input frequency	500Hz (duty ratio: 40%~60%)
Port filter time	Setting range: 1~65535 (default 1000), unit: 10μs; 1000 indicates 10ms. Able to set two groups of lter parameter. Every eight channels use a group of lter parameter.
Signal of logic 1	≥15V DC
Signal of logic 0	≤5V DC
OFF-ON response time	100μs
ON-OFF response time	100μs
Isolation method	Optocoupler
Input frequency decrease	Derate by 75% when operating at 55°C (with no more than 12 input points that are on at the same time), or by 10°C when all input points are on
Number of output channels	16
Output type	Source, active high
External power	DC24V (-15%~+20%)
Output voltage	24V±10%
Max. output frequency	1kHz
Max. load	Resistive load: 0.5A/point; 2A/module Inductive load: 7.2W/point; 12W/module Illumination load: 5W/point; 18W/module
Leakage current/point	<10uA
Protection against overheat/overcurrent/overvoltage	Supported
Exception check of external power	Supported
Isolation method	Magnetic
Short-circuit protection output	Yes
OFF-ON	100μs
ON-OFF	100μs
Weight	Net: 0.30(Kg) Gross: 0.33(Kg)
Dimensions (W×H×D)	Product dimension: 25×105×96mm Package dimension: 29×109×100mm

● Digital input & output (sink type)

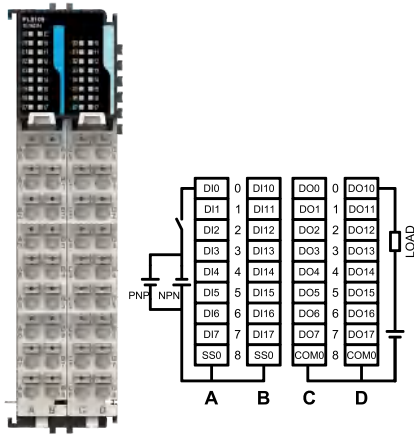

Model	FL5105
Ordering code	11016-00014
Product type	Digital input and output
Power loss	1.05W
Number of channels	16
Input type	Source/sink
Input voltage	DC24V±10%
Input current,typ	7mA
Max. input frequency	500Hz (duty ratio: 40%~60%)
Port filter time	Setting range: 1~65535 (default 1000), unit: 10μs; 1000 indicates 10ms. Able to set two groups of lter parameter. Every eight channels use a group of lter parameter.
Signal of logic 1	≥15V DC
Signal of logic 0	≤5V DC
OFF-ON response time	100μs
ON-OFF response time	100μs
Isolation method	Optocoupler
Input frequency decrease	Derate by 75% when operating at 55°C (with no more than 12 input points that are on at the same time), or by 10°C when all input points are on
Number of output channels	16
Output type	sink, active low
External power	DC24V (-15%~+20%)
Output voltage	24V±10%
Max. output frequency	1kHz
Max. load	Resistive load: 0.5A/point; 4A/module Inductive load: 7.2W/point; 24W/module Illumination load: 5W/point; 18W/module
Leakage current/point	<10uA
Protection against overheat/overcurrent/overvoltage	Supported
Exception check of external power	Supported
Isolation method	Magnetic
Short-circuit protection output	Yes
OFF-ON	100μs
ON-OFF	100μs
Weight	Net: 0.30(Kg) Gross: 0.33(Kg)
Dimensions (W×H×D)	Product dimension: 25×105×96mm Package dimension: 29×109×100mm

● Digital output (relay)

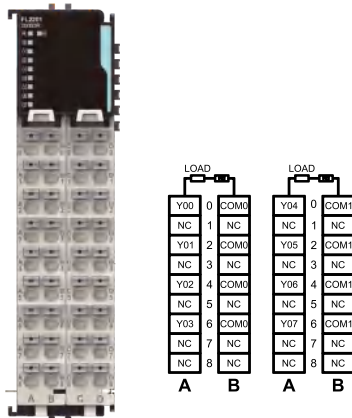

Model	FL2201
Ordering code	11016-00009
Product type	Digital output, relay output
Power loss	1.56W
Number of channels	8
Contact type	N.O. contact
Contact load (resistive)	3A 250VAC/30VDC
Max. switching voltage	250VAC/125VDC@0.3A
Max. switching current	5A
Service life of relay	Electrical: 100,000 times Mechanical: 20,000,000 times
OFF-ON response time	≤15ms
ON-OFF response time	≤10ms
Weight	Net: 0.30(Kg) Gross: 0.33(Kg)
Dimensions (W×H×D)	Product dimension: 25×105×96mm Package dimension: 29×109×100mm

• Analog input

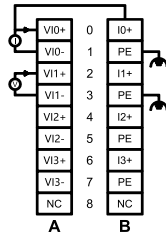

Model	FL3003
Ordering code	11016-00011
Product type	4 channels of analog input
Power consumption	0.83W
Number of channels	4
Voltage range	±5V, ±10V, +5V, +10V
Current range	0-20mA, 4-20mA, ±20mA
Accuracy in room temperature (of 25°C)	Voltage±0.1%FS, current±0.1%FS
Converting speed	320μs/channel
Max. common-mode voltage between channels	30VDC
Disconnection detection	Support (only voltage)
Isolation method	Between I/O port and power supply: isolated Between channels: not isolated
Resolution	16 bits
Weight	Net: 0.15(Kg) Gross: 0.18(Kg)
Dimensions (W×H×D)	Product dimension: 12.5×105×96mm Package dimension: 17.5×109×100mm

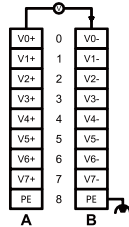

Model	FL3404
Ordering code	11016-00026
Product type	8-channel analog voltage input
Power consumption	0.81W
Number of channels	8
Voltage range	±5V, ±10V, 0~5V, 0~10V, 1~5V
Input mode	Differential
Accuracy in room temperature (of 25°C)	±0.15%FS
Accuracy in working temperature	±0.3%FS
Converting speed	170μs/channel
Voltage input limit	±15VDC
Max. common-mode voltage between channels	30VDC
Disconnection detection	Not supported
Over limit detection	Supported
Over range detection	Supported
Isolation method	Isolated between I/O ports and power supplies Not isolated between channels
Resolution	16 bits
Weight	Net: 0.15(Kg) Gross: 0.18(Kg)
Dimensions (W×H×D)	Product dimension: 12.5×105×96mm Package dimension: 17.5×109×100mm

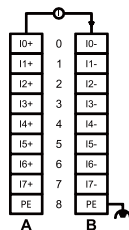

Model	FL3504
Ordering code	11016-00027
Product type	8-channel analog current input
Power consumption	0.81W
Number of channels	8
Current range	0~20mA, 4~20mA, ±20mA
Input mode	Differential
Accuracy in room temperature (of 25°C)	±0.15%FS
Accuracy in working temperature	±0.3%FS
Converting speed	170μs/channel
Current input limit	30mA
Max. common-mode voltage between channels	30VDC
Disconnection detection	Not supported
Over limit detection	Supported
Over range detection	Supported
Isolation method	Isolated between I/O ports and power supplies Not isolated between channels
Resolution	16 bits
Weight	Net: 0.15(Kg) Gross: 0.18(Kg)
Dimensions (W×H×D)	Product dimension: 12.5×105×96mm Package dimension: 17.5×109×100mm

● Analog output

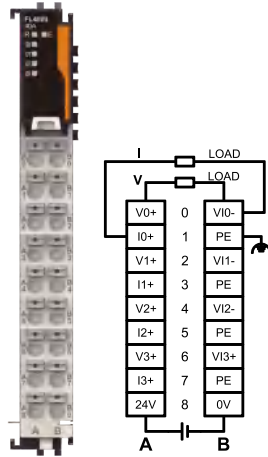

Model	FL4003
Ordering code	11016-00008
Product type	4 channels of analog output
External power	24VDC (-15%~+20%)
Power consumption	0.68W
Number of channels	4
Voltage range	±5V, ±10V, 0~5V, 0~10V
Current range	0~20mA, 4~20mA
Accuracy in room temperature (of 25°C)	Voltage ±0.1%FS, current ±0.1%FS
Converting speed	40μs/channel
Min. load resistance during voltage output	1kΩ
Max. load resistance during current output	600Ω
Disconnection detection	Support (only current)
Isolation method	Between I/O port and power supply: isolated Between channels: not isolated
Resolution	16 bits
Weight	Net: 0.15(Kg) Gross: 0.18(Kg)
Dimensions (W×H×D)	Product dimension: 12.5×105×96mm Package dimension: 17.5×109×100mm

● Temperature measuring (thermistor)

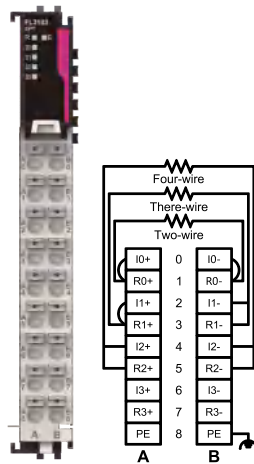

Model	FL3103
Ordering code	11016-00007
Product type	4 channels of thermistor input
Power consumption	0.88W
Number of channels	4
Wiring method	Two-, three-, or four-wire
Supported thermal resistors	PT100, PT500, PT1000, CU100
Sensitivity	0.0625°C/0.0625°F
SamplePeriod	240ms/channel (typical value)
Accuracy in room temperature (of 25°C)	±0.1%FS
Accuracy in working temperature	±1%FS
Filter time	Adjustable
Accuracy in working temperature	±0.3%FS
Isolation method	Between I/O port and power supply: isolated Between channels: not isolated
Weight	Net: 0.15(Kg) Gross: 0.18(Kg)
Dimensions (W×H×D)	Product dimension: 12.5×105×96mm Package dimension: 17.5×109×100mm

● Temperature measuring (thermocouple)

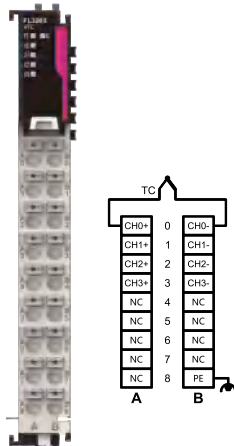

Model	FL3203
Ordering code	11016-00010
Product type	4 channels of thermocouple input
Power loss	0.78W
Number of channels	4
Supported thermocouples	Types B, E, J, K, N, R, S, and T
Sensitivity	0.0625°C/0.0625°F
SamplePeriod	360ms/channel
Accuracy in room temperature (of 25°C)	±0.1%FS+cold junction compensation error
Accuracy in working temperature	±0.3%FS+cold junction compensation error
Cold junction compensation method	Internal
Disconnection detection	Supported
Isolation method	Between I/O port and power supply: isolated Between channels: not isolated
Weight	Net: 0.15(Kg) Gross: 0.18(Kg)
Dimensions (W×H×D)	Product dimension: 12.5×105×96mm Package dimension: 17.5×109×100mm

● Counting and position measurement

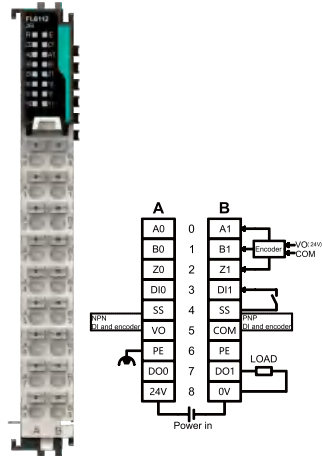

Model	FL6112
Ordering code	11016-00019
Product category	Incremental encoder module
Power consumption	0.68W
Number of channels	2
Encoder voltage	24VDC±15%
Counting range	-2147483648~2147483647
Pulse mode	AB-phase quadrature pulse/Pulse + direction
Pulse frequency	200KHz
Frequency multiplication mode	X1/X2/X4
Resolution	1-65535 ppr (number of pulses per revolution)
Counter preset	Software preset
Z-pulse calibration	Supported by default for Z signa
Counter filter	0.1~65535*0.1µs per channel
Number of DIs	1 per channel
DI voltage	24VDC
DI edge selection	Rising edge/Falling edge/Rising or falling edge
DI type	Source or sink
DI filter time setting	0.1~65535*0.1µs per channel
DI function	Latch and reset
Latched value	Total latched values and latch completion flags
ON/OFF response time	µs level
Number of DOs	1 per channel
DO voltage	24V
DO type	Sink type, max. current 0.16A
DO function	High-speed comparison output
Measurement variable	Frequency/Speed
Update time of the measurement function	20/100/500/1000ms
Gating function	Software gate
Weight	Net: 0.15(Kg) Gross: 0.18(Kg)
Dimensions (W×H×D)	Product dimension: 12.5×105×96mm Package dimension: 17.5×109×100mm

● Counting and position measurement

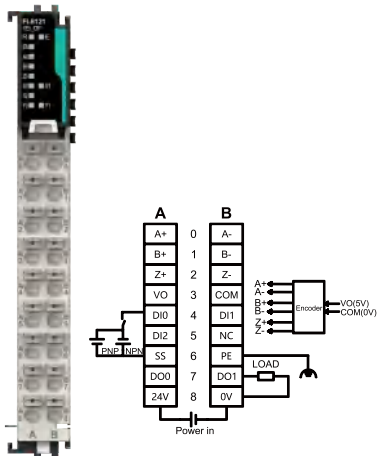

Model	FL6121
Ordering code	11016-00021
Product category	Incremental encoder module
Power consumption	0.68W
Number of channels	2
Encoder voltage	5VDC
Encoder signal type	RS422 electrical level standards, differential input
Counting range	-2147483648~2147483647
Pulse mode	ABZ-phase quadrature pulse/Pulse + direction
Pulse frequency	100Hz~2MHz
Frequency multiplication mode	X1/X2/X4
Resolution	1-65535ppr
Counter preset	Software preset
Z-pulse calibration	Supported by default for Z signa
Counter filter	(0~65535)*10ns
Number of DIs	3
DI voltage	24VDC±10%
DI edge selection	Rising edge/Falling edge/Rising or falling edge
DI type	Source or sink
DI filter time	0~65535*10ns per channel
DI function	2XLatch, 1XReset
Latched value	Latched value 0, latched value 1, and latch completion flags
Hardware reset	Rising edge reset
Number of DOs	2
DO voltage	24VDC
DO type	Source type, rated output current 0.16A
DO function	High-speed comparison output
Measurement variable	Frequency/Speed
Update time of the measurement function	20/100/500/1000ms
Gating function	Software gate
Weight	Net: 0.15(Kg) Gross: 0.18(Kg)
Dimensions (W×H×D)	Product dimension: 12.5×105×96mm Package dimension: 17.5×109×100mm

● Counting and position measurement

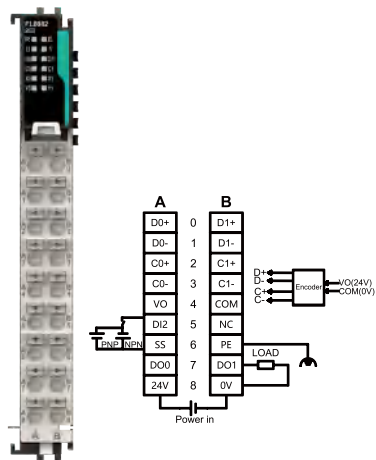

Model	FL6002
Ordering code	11016-00022
Product category	SSI absolute encoder module
Power consumption	0.69W
Number of channels	2
Encoder voltage	24VDC
Encoder signal type	RS422 electrical level standards, differential input
SSI frame length	10~40 (Default: 13)
SSI clock frequency	125K/250K/500K/1M/1.5M/2MHz
Signal type	Gray code (default) / Binary
SSI interval time	(1~65536)*100us
Number of DIs	1 per channel
DI voltage	24VDC
DI edge selection	Rising edge/Falling edge/Rising or falling edge
DI type	Source or sink
DI filter time	(1~65536) *0.1us
DI function	Latch
Latched value	Latched values and latch completion flags
Number of DOs	1 per channel
DO voltage	24V
DO type	Source type, rated output current 0.16A
DO function	High-speed comparison output
Measurement variable	Frequency/Speed
Update time of the measurement function	20/100/500/1000ms
Gating function	Software gate
Weight	Net: 0.15(Kg) Gross: 0.18(Kg)
Dimensions (W × H × D)	Product dimension: 12.5 × 105 × 96mm Package dimension: 17.5 × 109 × 100mm

● Resistance bridge measurement

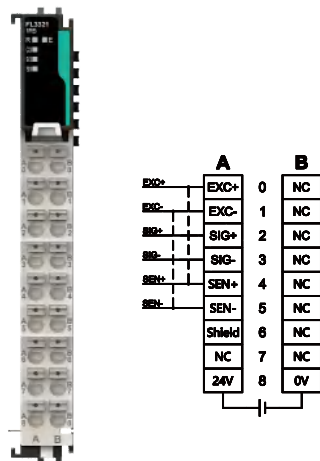

Model	FL3321
Ordering code	11016-00030
Product type	Resistance bridge measurement
Power consumption	0.5W
Number of channels	1
Input sensor type	4-wire or 6-wire bridge sensor
Input mode	Differential
Input signal range	±30mVDC
Load cell characteristics	(1/2/4/6)mV/V
Sampling time	2, 5, 10, 20, 40, 80 (default), 200, 400 ms × channel number (fine-tuning according to the ADC device)
Load range	40~4010Ω
Max. exciting current	5V@250mA
±0.01%FS (25°C, sampling rate < 80ms)	±0.01%FS (25°C, sampling rate < 80ms)
Accuracy in working temperature	±0.05%FS (-25°C~+55°C)
Disconnection detection	Supported
Short circuit detection	Exciting power short circuit detection supported
Over range detection	Supported
Isolation method	Not isolated between channels
Resolution	16 bits
Weight	Net: 0.15(Kg) Gross: 0.18(Kg)
Dimensions (W × H × D)	Product dimension: 12.5 × 105 × 96mm Package dimension: 17.5 × 109 × 100mm

Small PLC

Medium PLC

X86 Controller

I/O System

HMI

Industrial Internet

● Resistance bridge measurement

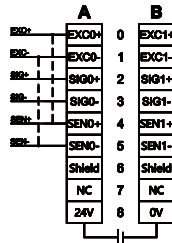

Model	FL3322
Ordering code	11016-00031
Product type	Resistance bridge measurement
Power consumption	0.55W
Number of channels	2
Input sensor type	4-wire or 6-wire bridge sensor
Input mode	Differential
Input signal range	±30mVDC
Load cell characteristics	(1/2/4/6)mV/V
Sampling time	2, 5, 10, 20, 40, 80 (default), 200, 400 ms × channel number (fine-tuning according to the ADC device)
Load range	40~4010Ω
Max. exciting current	5V@250mA
Accuracy in room temperature (of 25°C)	±0.01%FS (25°C, sampling rate < 80ms)
Accuracy in working temperature	±0.05%FS (-25°C~+55°C)
Disconnection detection	Supported
Short circuit detection	Exciting power short circuit detection supported
Over range detection	Supported
Isolation method	Not isolated between channels
Resolution	16 bits
Weight	Net: 0.15(Kg) Gross: 0.18(Kg)
Dimensions (W×H×D)	Product dimensions: 12.5×105×96mm Package dimensions: 17.5×109×100mm

● Pulse module

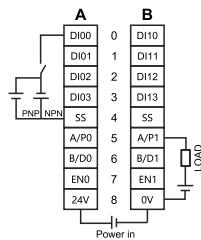

Model	FL7102
Ordering code	11016-00025
Product type	Pulse output module
Power consumption	0.75W
Number of pulse channels	2
Output mode	Single-ended NPN output
Output voltage range	(12~24VDC) ± 15%
Output frequency	Up to 200kHz
Pulse mode	Pulse + direction, CW/CCW
Input channel	8 channels (4 × 2CH)
Input channel function	Positive limit, negative limit, origin switch, and emergency stop
Input type	PNP/NPN
Input voltage range	24VDC ± 15%
Input signal logic	Limit, origin, and emergency stop are individually configured as normally open/normally closed, defaulting to normally open
Motion mode	Absolute position mode, relative position mode, and speed mode
Trapezoidal ACC/DEC	Supported
Motion merging	Supported
Homing mode	4 modes (19, 21, 24, 28) supported
Forced emergency stop	Supported
Refresh rate	≥ 1ms
Weight	Net: 0.15(Kg) Gross: 0.18(Kg)
Dimensions (W×H×D)	Product dimensions: 12.5×105×96mm Package dimensions: 17.5×109×100mm

● Power feed module

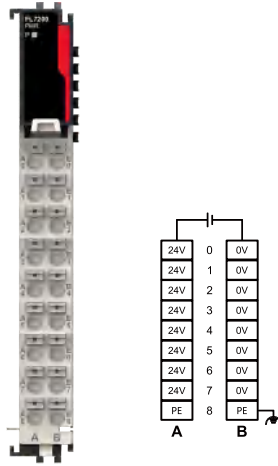

Model	FL7200
Ordering code	11016-00025
Product type	Power feed module
Power consumption	1.4W
Terminal input power rated voltage	24VDC±15%
Terminal input power rated current	0.7A (typical value at 24V)
Terminal current capacity	<4A
Terminal input power reverse connection protection	Supported
Fieldbus output power rated voltage	5VDC(4.5VDC ~ 5.5VDC)
Fieldbus output power rated current	2.5A (typical value at 25°C ambient temperature)
Fieldbus output power short circuit protection	Supported, hiccup-mode protection
Isolation method	No isolation
Module addressing	No addressing, no slot occupying
Module status reading	Not supported
Weight	Net: 0.15(Kg) Gross: 0.18(Kg)
Dimensions (W×H×D)	Product dimensions: 12.5×105×96mm Package dimensions: 17.5×109×100mm

● Network components

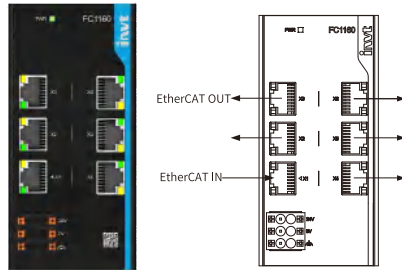

Model	FC1160
Ordering code	11016-00020
Product type	EtherCAT branch device
Power consumption	3.6W
Rated voltage	24VDC (-15%~+20%)
Number of EtherCAT ports	6 (1 input, 5 outputs)
Communication protocol	EtherCAT
Synchronization method	Distributed clocks (DCs)
Topology structure	Star (supporting splitter based cascade)
Physical layer	100BASE-TX
Data transmission rate	100MBit/s
Transmission mode	Full duplex
Output distance	Less than 100m between the two nodes
Weight	Net: 0.38(Kg) Gross: 0.41(Kg)
Dimensions (W×H×D)	Product dimensions: 50×105×112.8mm Package dimensions: 51×112×120mm

● Relay module

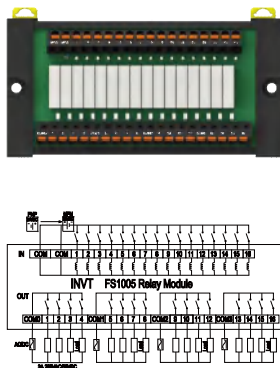

Model	FS1005
Ordering code	11016-00024
Product type	Digital input and relay output module
Power consumption	0.23W
Number of input channels	16
Input type	Source/sink
Input voltage	DC24V±10%
Input current (typical value)	7mA
Max. input frequency	500Hz (duty cycle: 40%~60%)
Port filter time	10ms
Logic 1 signal	≥15V DC
Logic 0 signal	≤5V DC
Isolation method	Relay isolation
Number of output channels	16
Output type	Relay
Touch point type	N.O. contact
Contact load (resistive)	3A 250VAC/30VDC
Max. switching voltage	250VAC/125VDC@0.3A
Max. switching current	5A
Relay lifespan	Electrical: 100,000 times Mechanical: 20 million times
Response time of OFF-ON	≤15ms
Response time of ON-OFF	≤10ms
Weight	Net: 0.157(Kg) Gross: 0.186(Kg)
Dimensions (W×H×D)	Product dimensions: 129.2×70.9×29.9mm Package dimensions: 142×90×37mm

I/O system product list

Ordering code	Model	Product type	Specifications
11016-00005	FK1100	Communication coupler (EtherCAT)	Coupler, EtherCAT, 24VDC; RoHS
11016-00012	FK1200	Communication coupler (Profinet)	Coupler, Profinet, 24VDC; RoHS
11016-00018	FK1300	Communication Coupler (EtherNet/IP)	Coupler, EtherNet/IP, 24VDC; RoHS
11016-00029	FK1400	Communication coupler (Modbus TCP)	Coupler, Modbus TCP, 24VDC; RoHS
11016-00004	FL1001	Digital input	Digital input module, 16 channels, supporting the source and sink types, 500mA@ 24 VDC inputs; RoHS
11016-00016	FL1002	Digital input	Digital input module, 32 channels, supporting the source and sink types, 500mA@ 24 VDC inputs; RoHS
11016-00006	FL2002	Digital output (source type)	Digital output module, with 16 channels of PNP transistor output, 500mA @ 24 VDC; RoHS
11016-00013	FL2003	Digital output (source type)	Digital output module, with 32 channels of PNP transistor output, 500mA @ 24 VDC; RoHS
11016-00003	FL2102	Digital output (sink type)	Digital output module, with 16 channels of NPN transistor output, 500mA @ 24 VDC; RoHS
11016-00017	FL2103	Digital output (sink type)	Digital output module, with 32 channels of NPN transistor output, 500mA @ 24 VDC; RoHS
11016-00045	FL5004	Digital input/output (source type)	Digital input/output, 8 channels of PNP input, 8 channels of PNP transistor output; RoHS
11016-00044	FL5104	Digital input/output (sink type)	Digital input/output, 8 channels of NPN input, 8 channels of NPN transistor output; RoHS
11016-00015	FL5005	Digital input/output (source type)	Digital input/output, 16 channels of input, 16 channels of PNP transistor output; RoHS
11016-00014	FL5105	Digital input/output (sink type)	Digital input/output, 16 channels of input, 16 channels of NPN transistor output; RoHS
11016-00009	FL2201	Digital output (relay)	Digital output, 8 relay outputs, dry contacts, 3A@30VDC/250VAC; RoHS
11016-00011	FL3003	Analog input	Analog input, 4 channels, 16-bit resolution, room-temperature accuracy of $\pm 0.1\%$ FS; RoHS
11016-00026	FL3404	Analog input	Analog input; 8 channels; voltage signals; 16-bit resolution; accuracy $\pm 0.15\%$ FS at room temperature
11016-00027	FL3504	Analog input	Analog input; 8 channels; current signal; 16-bit resolution; accuracy $\pm 0.15\%$ FS at room temperature
11016-00008	FL4003	Analog output	Analog output module, 4 channels, 16-bit resolution, room-temperature accuracy of $\pm 0.1\%$ FS; RoHS
11016-00007	FL3103	Temperature measurement (thermal resistor)	Thermal resistor detection, 4 channels, 24-bit resolution, sensitivity of $0.1^{\circ}\text{C}/^{\circ}\text{F}$; RoHS
11016-00010	FL3203	Temperature measurement (thermocouple)	Thermocouple detection, 4 channels, 24-bit resolution, sensitivity of $0.1^{\circ}\text{C}/^{\circ}\text{F}$; RoHS
11016-00019	FL6112	Counting module	Incremental encoder input, 2 channels, 24V single-ended, 200kHz; RoHS
11016-00021	FL6121	Counting module	Incremental encoder input, 1 channel, 5VDC differential, 2MHz; RoHS
11016-00022	FL6002	Counting module	SSI absolute input encoder module, 2 channels, 24VDC, 2MHz; RoHS
11016-00030	FL3321	Resistance bridge measurement	4-wire/6-wire resistor bridge sensor input, 1 channel, 24-bit, 5VDC, RoHS
11016-00031	FL3322	Resistance bridge measurement	4-wire/6-wire resistor bridge sensor input, 2 channel, 24-bit, 5VDC, RoHS
11016-00025	FL7102	Pulse module	Pulse output, 2 channels, 200kHz; RoHS
11016-00028	FL7200	Power feed module	Power feed; input: 24VDC, output: 5VDC 2.5A; RoHS
11016-00020	FC1160	EtherCAT branch device	Network component, EtherCAT, 6 ports, 100Mbit/s, 24VDC; RoHS
11016-00024	FS1005	Relay module	16 channels of input, supporting source/sink type, 16 channels of relay output, 5A@250VAC/30VDC



HMI

Friendly human-machine interaction experience



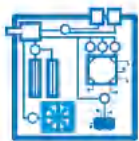

Powerful CPU

- Stable, efficient, safe, and reliable run in Linux.
- Industrial-grade high-performance processor.
- Cortex A7 CPU, with the main frequency up to 1.2GHz.



Diversified communication

- Multi-serial communication (RS232/422/485).
- Ethernet communication.
- Allowing one screen or multi-screen for one machine, or multi-screen for multi-machine.
- Optional IoT module, supporting remote monitoring, and remote program uploading and downloading.



Convenient configuration

- Multi-set recipes, multi-window function.
- Data acquisition, data alarm function.
- Macros are supported.
- Support for custom vector graphics.

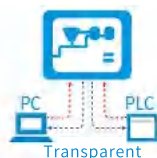

Featured function

- PC can communicate directly with the PLC via the HMI.
- Online simulation function, PC can be directly connected to the PLC simulation configuration project.
- USB, Ethernet, U disk three ways to update the configuration of the project.



IoT operation and maintenance

- Supporting WiFi networking method.
- Supporting remote upload and download, firmware update HMI/PLC.
- Supporting cloud platform data monitoring, historical data storage, and alarm push.
- Supporting cloud configuration, GIS mapping, and monitoring via the mobile app.



Safe and reliable

- Industrial-grade design, stable operation.
- High-capacity FLASH supports permanent storage of large capacity data without loss of power.
- Support USB flash drive data storage.
- New password mechanism, more secure and reliable to use.

VS-Q series

- 4.3/7.0/10.2/15.6"
- 16.77 million colors of true color display
- C language macros



Technical specification

Model	VS-043QE	VS-043QS	VS-070QE	VS-070QS	VS-070QS-G	VS-102QS-G	VS-102QS	VS-156QS	
Display									
Display size	4.3"	4.3"	7"	7"	7"	10.2"	10.2"	15.6"	
Resolution	480×272	480×272	800×480	800×480	1024×600	1024×600	1024×600	1920×1080	
Screen material	ITO								
Color depth	24 bits								
Brightness (cd/m ²)	400			450			300		
Backlight type	LED								
Backlight life (hr)	20000								15000
Touch panel type	4-wire high accuracy touch panel								
CPU and memory									
CPU	Cortex-A7 1GHz (dual core)								Cortex-A7 1.2GHz
Memory	128M DDR3								256M DDR3
Flash	128M Flash								4G (EMMC)
Communication interface									
USB	USB Client ×1, USB Host ×1								
Serial * interface	COM1	RS232	RS485	RS232	RS232	RS232	RS232	RS232	RS232
	COM2	RS485/422	-	RS485/422	RS485/422	RS485/422	RS485/422	RS485/422	RS485/422
	COM3	-	-	RS485	RS485	RS485	RS485	RS485	RS485
Ethernet	-	Support	-	Support	Support	Support	Support	Support	
SD card slot	-								
WIFI	-						Support		-
Power supply									
Rated voltage	12-24VDC (±15%)								
Rated power	3W			4W			7W		10W
Environment									
Work temperature	-20~55 °C								
Work humidity	5~95%RH (No condensation)								
Protection level	IP65 (front panel)								
Certification									
CE	En55032, EN55035								
FCC compatibility	FCC, Class A								
Dimensions and weight									
Physical dimension W*H*D (mm)	139×86×31	139×86×31	203×145×35	203×145×35	203×145×35	273×211×40	273×211×40	395×257×31	
Hole dimension A*B (mm)	132×80	132×80	192×138	192×138	192×138	259×201	259×201	383×246	
Weight (Kg)	0.2	0.2	0.7	0.7	0.7	1.05	1.05	2.45	
Configuration									
Configuration software	HMITOOL								

Note: ● Indicates Support - Indicates not supported * In the serial interface, DB9 is a male socket

Dimension

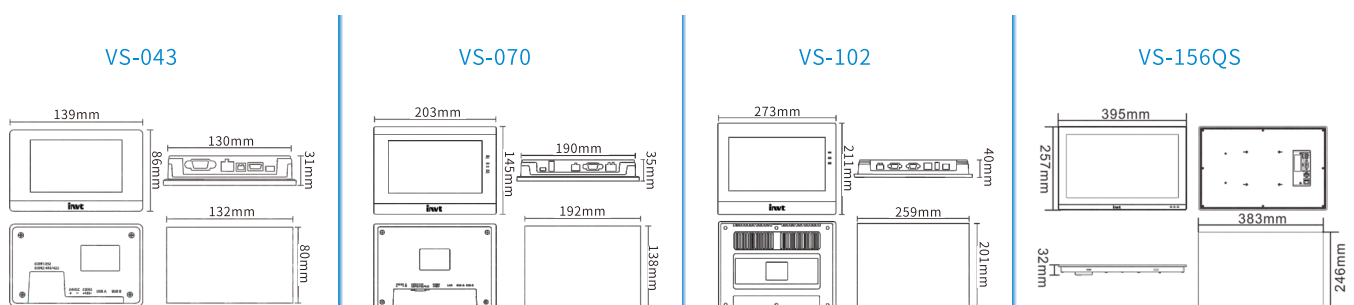

VA series

- 7.0/10.1"
- 3 serial ports
- Backlight life 20,000hrs
- Up to 30 screens, 100 macros



Technical specification

Model		VA2070-N0CXR	VA2100-N0CXR
Display			
Display size		7"	10.1"
Resolution		800×480	1024×600
Screen material		TFT	
Color depth		16 bits	
Brightness (cd/m ²)		350	250
Backlight type		LED	
Backlight life (hr)		20000	
Touch panel type		4-wire resistive screen	
CPU and memory			
CPU		RISC ARM9 32Bit 300MHz	
Memory		64MB DDR3	
Flash		128MB Flash	
Number of screens		30 pages	
Interface			
USB		Host: USB2.0×1 / Client: USB2.0×1	
Serial * interface	COM1	RS232 (DB9)	RS232 (DB9)
	COM2	RS485/422 (DB9)	RS485/422 (DB9)
	COM3	RS485 (DB9)	RS485 (DB9)
Ethernet interface		-	-
Micro SD card slot		-	-
Power supply			
Rated voltage		24VDC (±10%)(Isolation)	
Rated power		10W	20W
Environment			
Work temperature		-10~50°C	
Work humidity		10~90%RH (No condensation)	
Protection level		IP54 (Front board)	
Certification			
CE		EN61000-6-2, EN61000-6-4	
FCC compatibility		FCC, Class A	
RoHS		●	●
Dimensions and wight			
Physical dimension W*H*D (mm)		203.5×148.5×31.5	270.8×212.8×42.5
Hole dimension A*B (mm)		191.5×138	259×201
Weight (Kg)		0.55	1.1
Configuration			
Configuration software		VT Designer	

Note: ● Indicates Support - Indicates not supported * In the serial interface, DB9 is a female socket

Dimension

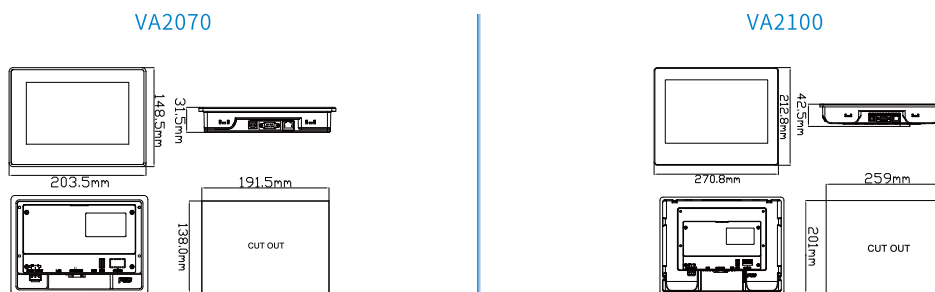

VK series

- 4.3/7.0/10.1"
- 3 serial ports
- Backlight life 20,000hrs
- Support macros



Technical specification

Model	VK2043-N0CXN	VK2043-N0CXR	VK2043-N0EXR	VK2070-N0EXR	VK2070-N0CXR	VK2100-N0CXR	VK2100-N0EXR
Display							
Display size	4.3"	4.3"	4.3"	7"	7"	10.1"	10.1"
Resolution	480×272	480×272	480×272	800×480	800×480	1024×600	1024×600
Screen material	TFT						
Color depth	16 bits						
Brightness (cd/m ²)	400	400	400	400	400	350	350
Backlight type	LED						
Backlight life (hr)	20000						
Touch panel type	4-wire resistive screen						
CPU and memory							
CPU	RISC ARM9 32Bit 300MHz						
Memory	64MB DDR3						
Flash	128MB Flash						
Number of screens	7999 pages						
Interface							
USB	USB Host: USB2.0×1 / USB Client: USB2.0×1						
Serial interface *	COM1	-	RS232 (5-PIN terminal connector)		RS232 (DB9)		
	COM2	-	RS422/485 (5-pin terminal connector)		RS422/485 (DB9)		
	COM3	RS485 (5-pin terminal connector)			RS485 (DB9)		
Ethernet interface	-	-	10M/100M BASE-T×1	10M/100M BASE-T×1	-	-	10M/100M BASE-T×1
Micro SD card slot	-						
Power supply							
Rated voltage	24VDC (±10%)(Isolation)						
Rated power	10W	10W	10W	20W	20W	20W	20W
Environment							
Work temperature	-10~60° C						
Work humidity	10~90%RH (No condensation)						
Protection level	IP65 (Front board)						
Certification							
CE	EN61000-6-2, EN61000-6-4						
FCC compatibility	FCC, Class A						
RoHS	●	●	●	●	●	●	●
Dimensions and weight							
Physical dimension W*H*D (mm)	129×103×33	129×103×33	129×103×33	203.5×148.5×37	203.5×148.5×37	270.8×212.8×42.5	270.8×212.8×42.5
Hole dimension A*B (mm)	118.5×92.5	118.5×92.5	118.5×92.5	191.5×138	191.5×138	259×201	259×201
Weight (Kg)	0.23	0.23	0.23	0.55	0.55	1.1	1.1
Configuration							
Configuration software	VT Designer						

Note: ● Indicates Support - Indicates not supported * In the serial interface, DB9 is a female socket

Dimension

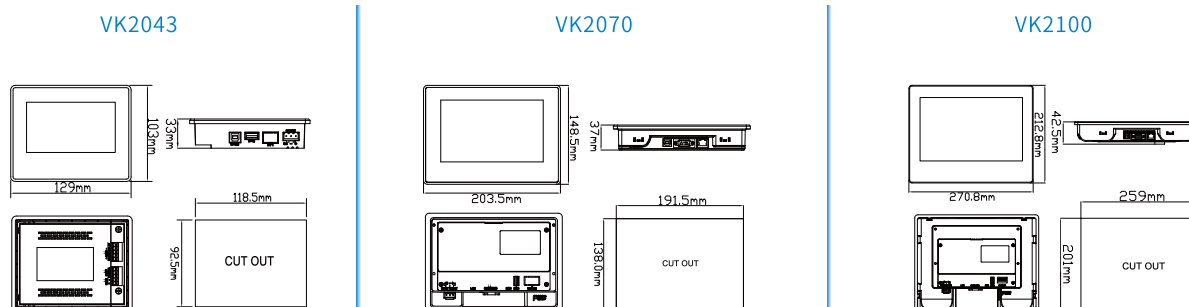

VT series

- 7.0/10.4"
- Up to 5 serial ports
- Isolation design
- Backlight life 20,000hrs
- Support macros



Technical specification

Model		VT2070-NOCTR-24	VT2070-H1ETR-31	VT2104-H0ETR-51
Display				
Display size		7"	7"	10.4"
Resolution		800×480	800×480	800×600
Screen material			TFT	
Color depth			16 bits	
Brightness (cd/m ²)			400	
Backlight type			LED	
Backlight life (hr)			20000	
Touch panel type			4-wire resistive screen	
CPU and memory				
CPU			RISC ARM9 32Bit 300MHz	
Memory			64MB DDR3	
Flash			128MB Flash	
Number of screens			7999 pages	
Interface				
USB			USB Host: USB2.0×1 / USB Client: USB2.0×1	
Serial * interface	COM1	RS232 (DB9)	RS232/422/485 (DB9)	RS232 (DB9)
	COM2	RS422/485 (DB9)	RS485 (5-PIN terminal)	RS422/485 (DB9)
	COM3	-	RS485 (DB9)	RS485 (DB9)
	COM4	-	-	RS485 (5-pin terminal)
	COM5	-	-	RS485 (5-pin terminal)
Ethernet interface		-	10/100M BASE-T×1	10/100M BASE-T×1
Micro SD card slot		-	Micro SD	-
Power supply				
Rated voltage			24VDC (±10%)(Isolation)	
Rated power		20W	20W	20W
Environment				
Work temperature			-10~60°C	
Work humidity			10~90%RH (No condensation)	
Protection level			IP66 (Front board)	
Certification				
CE			EN61000-6-2, EN61000-6-4	
FCC compatibility			FCC, Class A	
RoHS		●	●	●
Dimensions and wight				
Physical dimension W*H*D (mm)		188×143.3×40	188×143.3×40	270.8×212.8×42.5
Hole dimension A*B (mm)		174.5×132.5	174.5×132.5	259×201
Weight (Kg)		0.55	0.55	1.1
Configuration				
Configuration software			VT Designer	

Note: ● Indicates Support - Indicates not supported * In the serial interface, DB9 is a female socket

Dimension

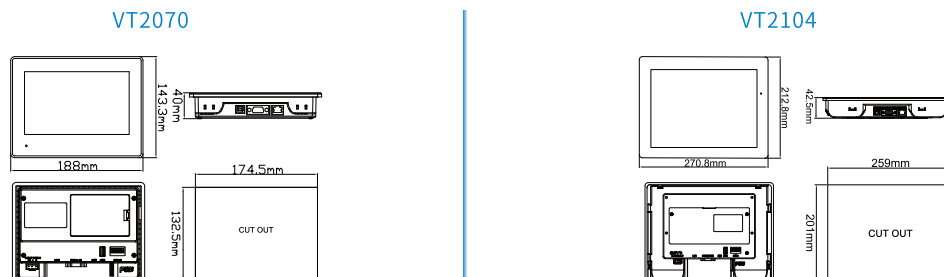

VS Series Intergrated Machine

- Size of 7.0 inches
- HMI-PLC AIO
- Diverse communication methods
- Easy configuration



Technical specification

Model		VS070QS-1618MDM1
Display		
Display size		7"
Resolution		800×480
Screen material		TFT
Color depth		24 bits
Brightness (cd/m ²)		450
Backlight type		LED
Backlight life (hr)		20000
Touch panel type		4-wire resistive
Processor and memory		
Processor		Cortex-A7 1GHz
Memory		128MB DDR3
Flash memory		128MB Flash
Interface		
USB		USB Host×1 / USB Client×1
Serial * interface	COM1	RS485
	COM2	RS232
Ethernet		Supported
SD card socket		-
Power supply		
Rated voltage		24VDC (±15%)
Rated power		7W
Input		
Digital		16
Analog		2 channels
Output		
Digital		18
Analog		1 channel
Environment		
Working temperature		-20~55°C
Working humidity		5~95%RH (no condensation)
IP rating		IP65 (front panel)
Certification		
CE		En55032, En55035
FCC compatibility		FCC, Class A
RoHS		●
Dimensions and wight		
Physical dimension W*H*D (mm)		203×145×56
Hole dimension A*B (mm)		192×138
Weight (Kg)		0.8
Configuration		
Configuration software		HMI TOOL + Auto Station

Note: ● Indicates Support - Indicates not supported * In the serial interface, DB9 is a female socket

Dimension

VS070QS-1618MDM1

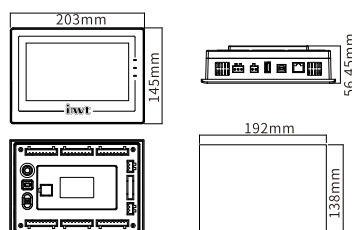

HMI-VS-Q series wireless module

Modules can be mounted to the HMI interface with fasteners, plug and play



Product model	VS-Q-WIFI
Networking method	WIFI
Network frequency	IEEE 802.11b
frequency band	IEEE 802.11g
	IEEE 802.11n
Network reconnection	Supported
Offline transmission resuming	Supported
API interface	Supported
VNC function	Supported
Data monitoring	Support up to 280 data points
Historical data	Supports up to 20,000 data items
Alarm push	Support client push and WeChat public account push

IWOcloud IoT cloud platform free application

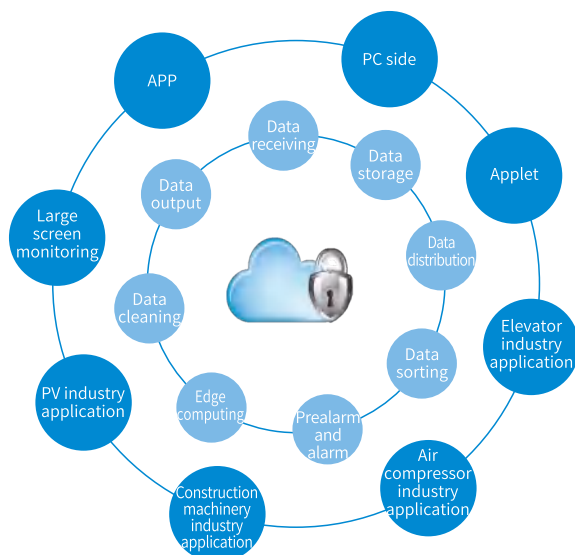

HMI product list

Product	Material code	Model	Description	Cut-out size
VS-Q series	11026-00025	VS-043QE	4.3", 480×272, 24bit color, 2 serial port, RoHS	132×84mm
	11026-00031	VS-043QS	4.3", 480×272, 24bit color, 2 serial port, 1 Ethernet port, RoHS	132×84mm
	11026-00022	VS-070QE	7.0", 800×480, 24bit color, 3 serial port, RoHS	192×138mm
	11026-00023	VS-070QS	7.0", 800×480, 24bit color, 3 serial ports, 1 Ethernet port, RoHS	192×138mm
	11026-00029	VS-070QS-G	7.0", 800×480, 24bit color, 3 serial ports, 1 Ethernet port, support the expansion of the IoT, RoHS	192×138mm
	11026-00024	VS-102QS	10.2", 1024×600, 24bit color, 3 serial port, 1 Ethernet port, RoHS	259×201mm
	11026-00028	VS-102QS-G	10.2", 1024×600, 24bit color, 3 serial port, 1 Ethernet port, support the expansion of the IoT, RoHS	259×201mm
	11026-00026	VS-156QS	15.6", 1920×1080, 24bit color, 3 serial port, 1 Ethernet port, RoHS	383×246mm
	11095-00023	VS-Q-WIFI	Wi-Fi module, supporting network frequency segments IEEE802.11b, IEEE802.11g, IEEE802.11n, need to be used with the IoT screen	-
VA series	11060-00320	VS070QS-1618MDM1	7.0" Inch AIO, with built-in 16 channels of digital input, 18 channels of digital output, 2 channels of analog input, 1 channel of analog output	192×138mm
	11060-00156	VA2070-N0CXr	7.0", 800×480, 16bit color, 3 serial ports, no Ethernet port	191.5×138mm
VK series	11060-00157	VA2100-N0CXr	10.1", 1024×600, 16bit color, 3 serial ports, no Ethernet port	259×201mm
	11060-00172	VK2043-N0CXN	4.3", 480×272, 16bit color, 2 serial ports, no Ethernet port	118.5×92.5mm
	11060-00272	VK2043-N0CXr	4.3", 480×272, 16bit color, 3 serial ports, no Ethernet port	118.5×92.5mm
	11060-00173	VK2043-N0EXr	4.3", 480×272, 16bit color, 3 serial ports, 1 Ethernet port	118.5×92.5mm
	11060-00169	VK2070-N0EXr	7.0", 800×480, 16bit color, 3 serial ports, 1 Ethernet port	191.5×138mm
	11060-00171	VK2070-N0CXr	7.0", 800×480, 16bit color, 3 serial ports, no Ethernet port	191.5×138mm
	11060-00168	VK2100-N0CXr	10.1", 1024×600, 16bit color, 3 serial ports, no Ethernet port	259×201mm
	11060-00167	VK2100-N0EXr	10.1", 1024×600, 16bit color, 3 serial ports, 1 Ethernet port	259×201mm
	VT series	11026-00017	VT2070-H1ETR-31	7.0", 800×480, 16bit color, 3 serial ports, 1 Ethernet port
11026-00018		VT2070-N0CTR-24	7.0", 800×480, 16bit color, 32 serial ports, no Ethernet port, 1MB (backup)	174.5×132.5mm
11026-00016		VT2104-H0ETR-51	10.4", 800×600, 16bit color, 5 serial ports, 1 Ethernet port	259×201mm

Industrial Internet

Cloud platform | Application system | Cloud platform | Cloud services

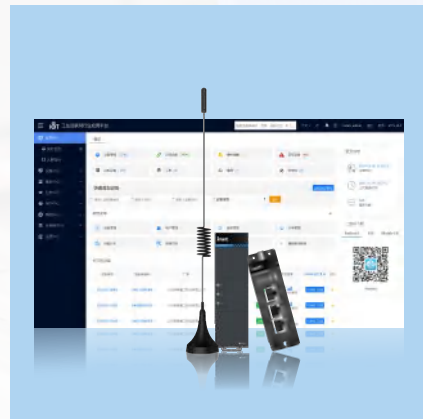

INVT independently develops and owns four industrial Internet products, namely, IWOCLOUD industrial Internet cloud platform, WOScene application system, IWOLink data terminal products, and ICS industrial cloud service. In combination with INVT industrial automation products, we provide end-to-end integrated solutions for industry customers, helping them to move towards a new journey of digital transformation!

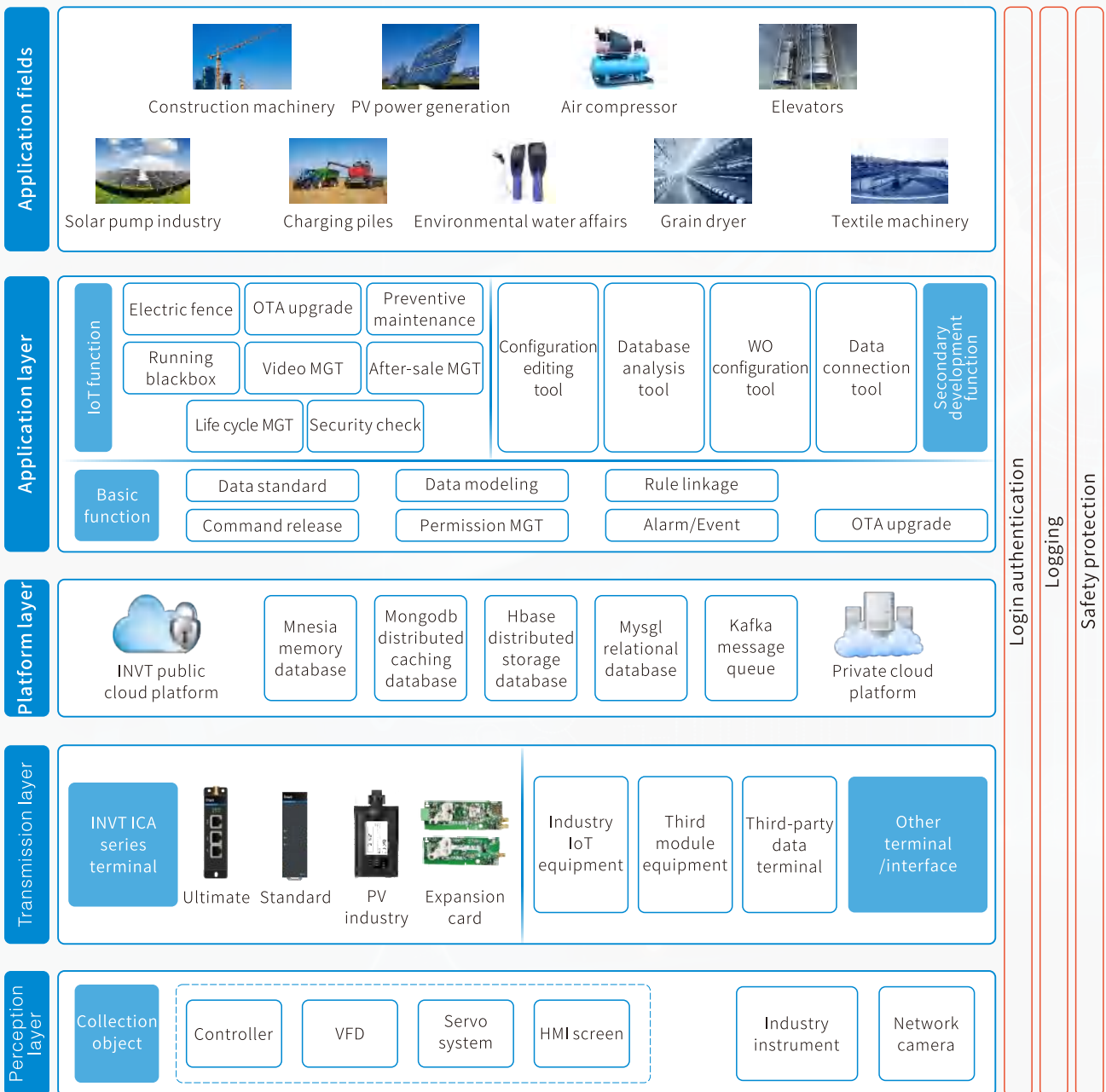

IWOScene-SCADA: acquisition and monitoring system

Integrate equipment monitoring functions in various dimensions to meet the needs for equipment monitoring, including real-time monitoring of the safe operation, operation efficiency and effectiveness of the equipment in the form of large screens.

● Data cockpit

Management without leaving home

Through web pages in a mobile or a computer, large screen monitoring and other forms, you can quickly grasp the APP real-time status of the equipment, and carry out video monitoring, remote start/stop, and modification of parameters, and so on.

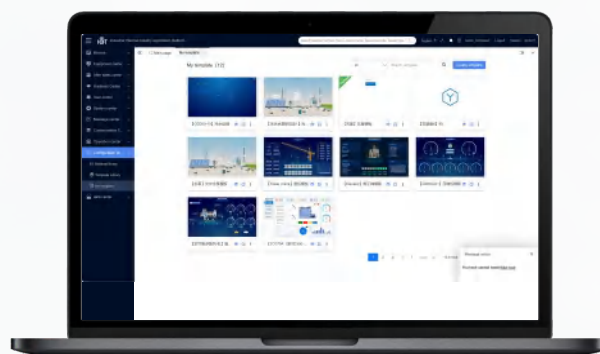

● Free configuration monitoring

Manage affairs without leaving home

The platform has built-in configuration editing tools, allowing users to configure their own configuration monitoring pages.



● Historical data

Integrates the functions for system operation and daily platform management to meet the needs for system management, including system settings, operation records, user data statistics, enterprise dynamic management, etc.

● Historical data query

Multidimensional application of data

You can customize the type of the focused parameter, address, type, chart, and fault.
You can also customize data charts for display, and export historical data to the local server in various types of files.

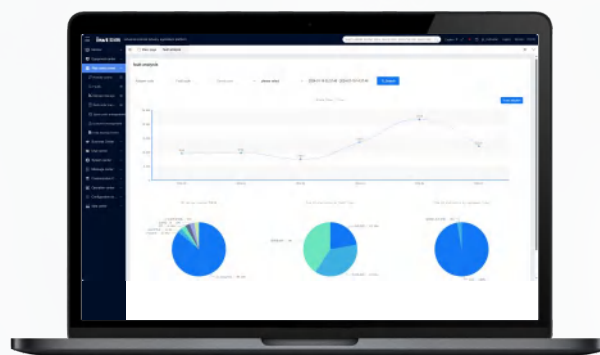

- Data analysis and statistics

- Objective data support for fault analysis**

For historical data, various statistical reports can be customized and generated, facilitating multi-dimensional data analysis applications. Based on different user needs, statistical analysis includes the assessment and statistical analysis of various equipment parameters, providing objective data support for decision-making in various departments such as research and development, after-sales, and sales.

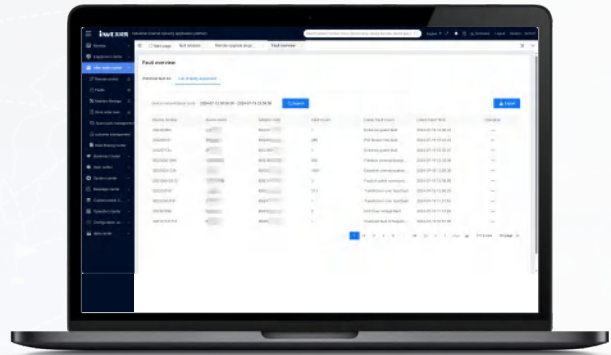

IWOScene-OMS: Operation and maintenance system

- Remote assistance

- Remote upgrade of equipment

- Remote upgrade without leaving home**

You can remotely upload, download, and monitor device equipment programs, including PLC, VFD, data terminal modules, etc.

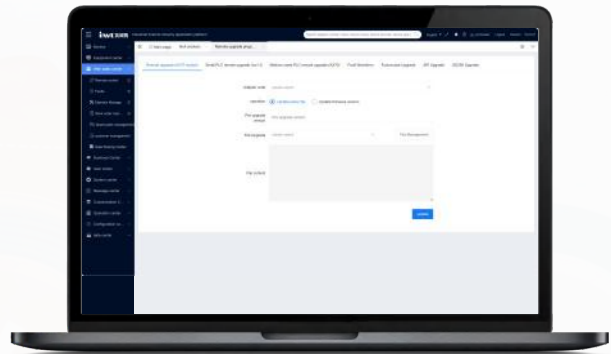

- Fault management

- Fault pre-alarm/alarm

- Electronic sentry, real-time guarding of equipment**

The system provides timely feedback on alarm information and push them through APP SMS, e-mail and other forms. For the key parameters of the key equipment, pre-alarm values can be set to detect faults before they occur.

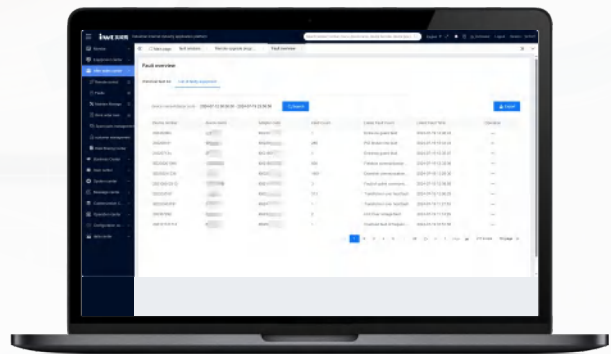

Integrates functions for after-sales maintenance, improving the efficiency of after-sales maintenance of user equipment, including: fault management, maintenance management, work order management, spare parts management, etc.

● Preventive maintenance

Passive after-sales service becomes proactive service

This includes prediction of equipment service life, preventive cleaning of key components, life cycle management of maintenance parts, equipment exception pre-alarm, etc.

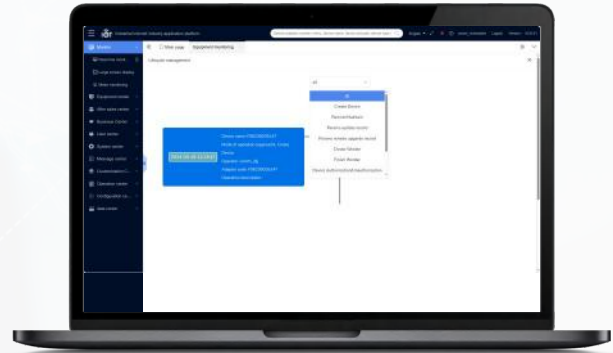

● Maintenance management

"Digital housekeeper" of equipment

The system can set the maintenance cycle for the monitoring equipment as a whole or components, and the maintenance logic can be customized, including countdown and event triggering.

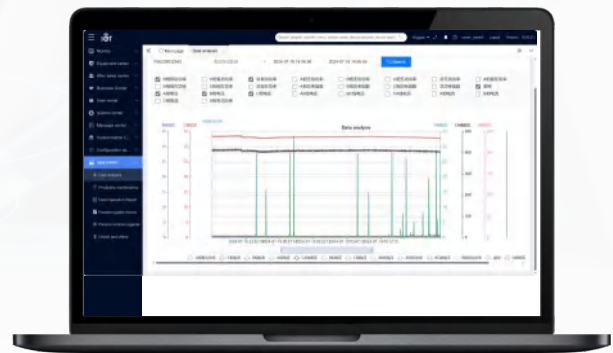

● Work order management

● After-sale WO management

Online processing of after-sale business

You can circulate a series of after-sales work orders such as faults, installation, and repair, and monitor the entire process of handling the results, improving the efficiency of after-sales maintenance work, enhancing user experience and corporate image.

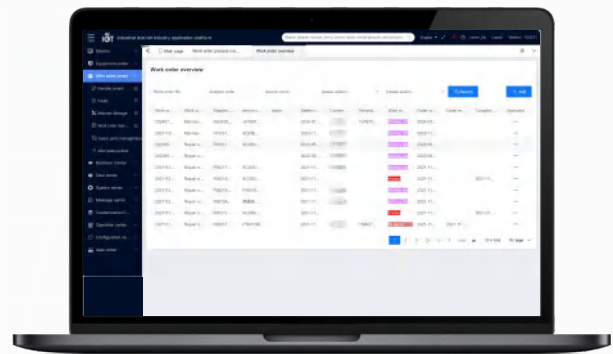

Small PLC
Medium PLC
X86 Controller
I/O System
HMI
Industrial Internet

System features

INVT provides industrial enterprises with complete, reliable, flexible, and quick-deliverable solutions.



Pan-access

Supporting various VFDs, servo, PLC, and HMI screens.



Multiple presenting

Supporting PC and mobile app (on Android and iOS)



Privatization deployment

The system cloud platform supports privatization deployment



Safe and stable

Supporting the pushing by means of mobile app, email, and SMS message



Multimedia access

Supporting onsite video, image, and interface access, and AI recognition of face.



Quick start

Easy to operate and user friendly interface



Personalized customization

Application system functions can be customized



Data analysis

Historic data, condition collection, and data reports



Alarm pushing

Data is encrypted before transmission, and servers are managed in distributed mode



Data interface

The platform provides the API, eliminating data silos

Multiple login methods

Go to the login interface through <https://iot.invt.com/> with a PC



Login through the INVT APP with a mobile

Download methods: iOS: App Store > Search "INVTIOT" > Download

Android: App Store > Search "Invt cloud"



Large-screen application

Customized large-screen display can be applied to system data, which can be planned as follows:

- Macro data: Device distribution map, online/fault/alarm device distribution
- System key statistics: Device status statistics and work order quantity display



IWOLink data terminal product

To flexibly adapt to the data acquisition needs of various industrial equipment and different network scenarios, INVT has launched a series of data acquisition products to provide fast, easy, and secure IoT data connection solutions.

ICA417 series

Excellent performance

Edge computing, VPN transparent transmission, and remote OTA makes you feel like you are there!



4G Ultimate

TBox series

Super applicability

One device supports multiple scene applications!
(Serial to 4G, Serial to Network port, Network port to 4G)



4G Standard

ICA400-06 series

With Wi-Fi

Dedicated to the PV industry, worry free network connection!



PV industry

EC-IC series

Perfect match

With a built-in card, traditional devices are perfectly upgraded with IoT functions!



Expansion card

Technical specifications

Data Terminal Products	TBox	TBox-EU	TBox-LA	TBox-4G	ICA100-02	ICA400-02-CN	ICA417-02-CN
Ordering Code	11095-00035	11095-00036	11095-00041	11095-00034	11095-00008	11095-00004	11095-00019
Product Positioning	Standard Version	Standard European Version	Standard Latin American Version	Youth Version	WiFi Version	4G-pro Version	4G Flagship Version
SIM Card	Comes with a 1GB/month data SIM card	No SIM card		Comes with a 1GB/month data SIM card	No need for a SIM card	Comes with a 30MB/month data SIM card	Comes with a 2GB/month data SIM card
Communication Parameters							
Upstream Networking	4G/Ethernet Port/WiFi			4G/Ethernet Port	WiFi(2.4GHz)	4G	4G/Ethernet Port
Upstream Network Speed	5Mbps				10Mbps	5Mbps	50Mbps
Downstream Communication	RS485/RS232/Ethernet Port				RS485/232	RS485/232	RS485/RS232 /Ethernet Port
Downstream Network Speed	10Mbps				54Mbps	10Mbps	100Mbps
Hardware Parameters							
Protection Level	IP20						
Supply Voltage	DC 10~24V						
Overall Power Consumption	3W			2W		3W	
Indicator Lights	Power Indicator, Network Status Indicator, Operation Status Indicator						
Installation Method	Standard Rail Mounting						
Operating Temperature	-25°C~65°C						
International Version	CN Version	EU Version	LA Version	CN Version	Internationally Universal	CN Version, This Series Supports EU/LA Versions	
Antenna	External				WiFi Antenna	External	
Bluetooth Debugging	Supported				Not Supported		
Shell Material	Engineering Plastic						Sheet Metal
Software Functions							
Real-time Data Monitoring	Supported						
Edge Computing	Supported in Non-standard Cases						
FOTA Remote Upgrade	Supports Inverter Upgrade (GD270/350 Platform Dedicated Products)				Not Supported	Supports Inverter Upgrade (GD270/350 Platform Dedicated Products)	
Serial Port Transparency Transmission	Supported				Not Supported	Supported	
Ethernet Port VPN Transparency Transmission	Supported				Not Supported		Supported

Structure size

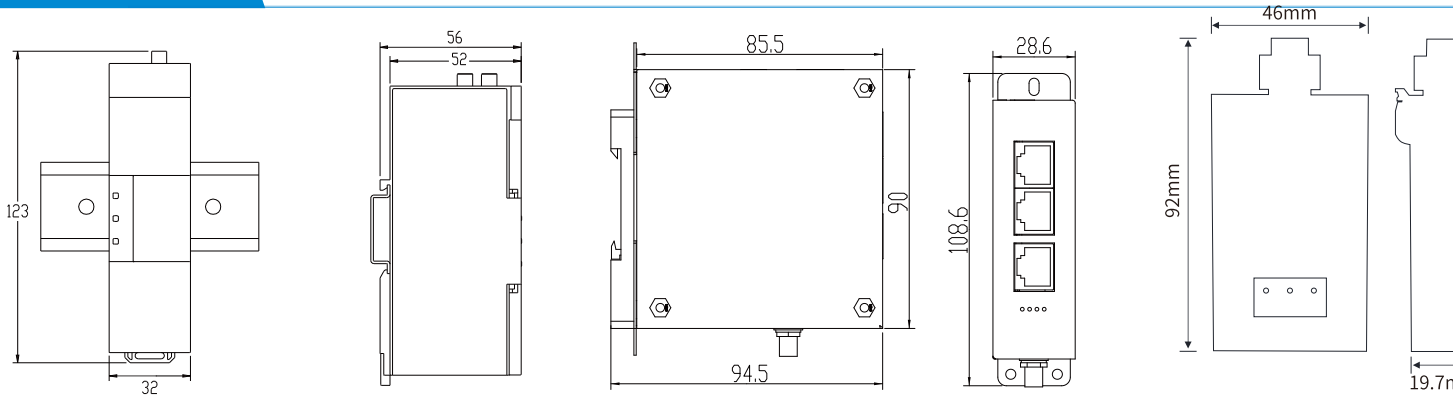

Model	Dimensions (W×H×D) (including rail clips)	Weight (excluding antenna)
TBox series	32×123×56mm	55g

Model	Dimensions (W×H×D) (including rail clips)	Weight (excluding antenna)
ICA417series	28.6×108.6×94.5mm	153g

Model	Dimensions (W×H×D) (including rail clips)
ICA-06 series	46×92×28.6mm

[Positioning: 3-in-1 version \(RS485 to 4G/RS485 to network port/network port to 4G\)](#)
[Features: RTU performance at the price of a DTU](#)

[Positioning: 4G Ultimate version \(high-speed 4G cat 4 version\)](#)
[Features: VPN transparent transmission, perfect support for remote debugging](#)

TBox-4G/A	TBox-4G/A-EU	EC-IC502-2-CN	ICA400-06N	ICA400-26-EU	ICA400-26N-EU	ICA400-26N-LA	ICA100-06N-EU	ICA400-00HNPC
11095-00038	11095-00037	11095-00009	11095-00025	11095-00039	11095-00039	11095-00040	11095-00029	34008-00160
Elevator Industry Version	Elevator Industry European Version	4G Expansion Card for Inverter	4G Version for Photovoltaic Industry	4G Version for Photovoltaic Industry	4G European Version for Photovoltaic Industry	4G Latin American Version for Photovoltaic Industry	WiFi Version for Photovoltaic Industry	Youth Version for Photovoltaic Water Pump Industry
Comes with a 30MB/month voice data SIM card	No SIM card	Comes with a 30MB/month data SIM card			No SIM card		No need for a SIM card	No SIM card
4G 5Mbps							WiFi (2.4GHz) 10Mbps	4G/3G/2G 5Mbps
RS485/232/AUX/Type-c		RS485/232						
10Mbps							54Mbps	10Mbps
IP20		IP00		IP65				IP00
DC 10~24V				DC 5~12V				DC 10~24V
3W				3.5w			1.5w	2W
Server Indicator, Network Status Indicator, Operation Status Indicator								
Standard Rail Mounting		Screw		Aviation Interface				Screw
-25°C~65°C								
CN Version	EU Version	CN Version, This Series Supports EU/LA Versions		Supports CN/EU Versions	EU Version	LA Version	Supports CN/EU Versions	CN Version
External		Internal						
Supported (Optional)		Not Supported		Supported				Not Supported
Engineering Plastic		No Shell		Engineering Plastic				No Shell
Supported								
Supported in Non-standard Cases								
Supports Inverter Upgrade (Elevator, GD270/350 Platform Dedicated Products)		Supports Inverter Upgrade (GD270/350 Platform Dedicated Products)		Supports Inverter Upgrade				Supports Inverter Upgrade (GD270/350 Platform Dedicated Products)
Supported				Not Supported				Supported
Not Supported								

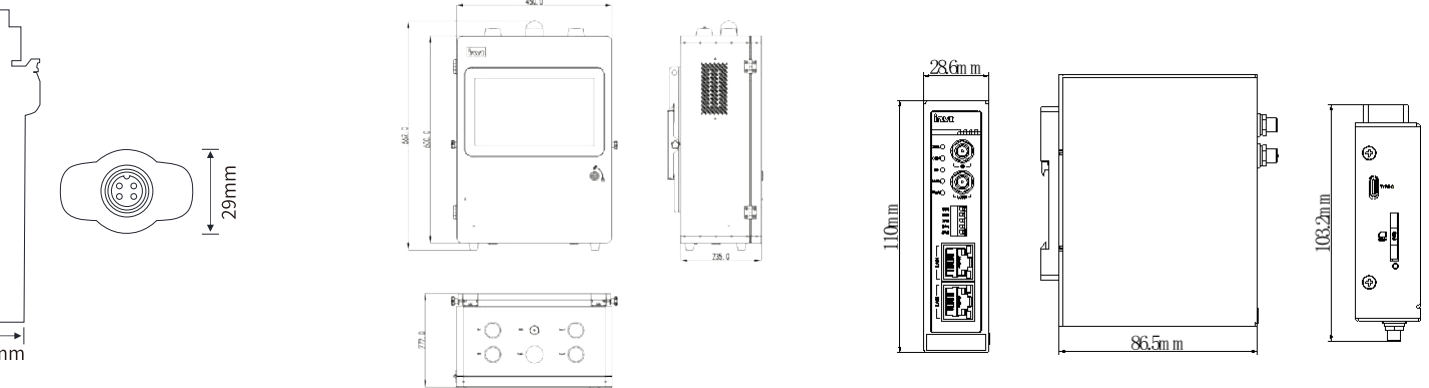

W×H×D (including clips)	Weight (excluding antenna)
29mm	47g

Model	Dimensions (W×H×D) (including rail clips)	Weight (excluding antenna)
ICA-C Control Cabinet	450×600×662mm	28.6kg

Model	Dimensions (W×H×D) (including rail clips)	Weight (excluding antenna)
ICA-E Edge Terminal	28.6×103.2×110mm	0.65kg

Small PLC

Medium PLC

X86 Controller

I/O System

HMI

Industrial Internet

IWOCloud industrial cloud platform

INVT develops the industrial IoT data processing platform to provide a stable, safe, and high-efficiency base for various IoT industries and application scenarios. As the IoT "brain", the platform provides large-scale data terminal node access and high concurrent terminal access capability to accept, clean, arrange, distribute, and save data uploaded from various devices. In addition, it provides standard database interfaces in unified data format externally, meeting enterprise informationization development needs.

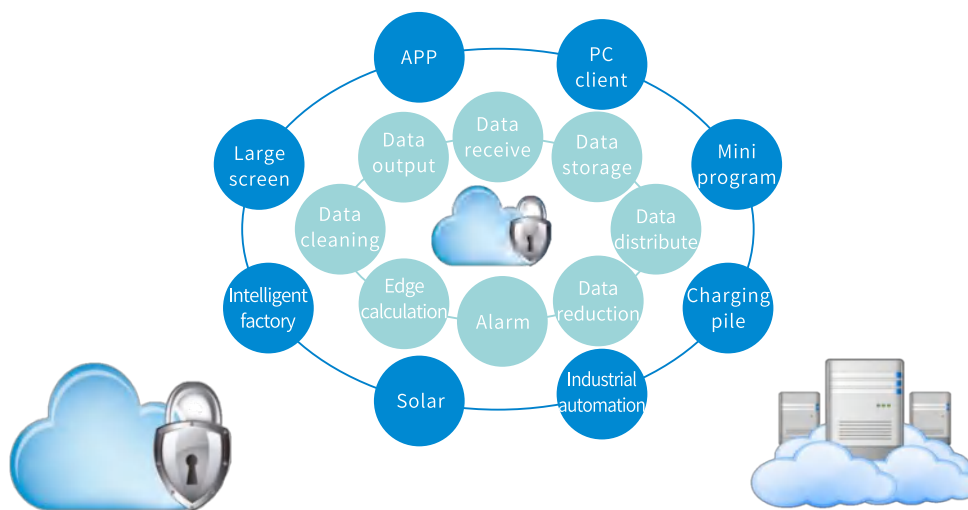

INVT public cloud platform

Customers upload device acquired data to INVT cloud platform (IWOCloud)

- System running: safe and stable
- Maintenance: at low cost

Privatized IoT platform

Customers can deploy industrial cloud platform with private permissions on specified servers, and upload device acquired data to the platform.

- Data privatization
- Maintenance: at high cost for the need of specialist for system stability maintenance



Small PLC
Medium PLC
X86 Controller
I/O System
HMI
Industrial Internet

Industrial cloud service



Policy file maintenance service

ICS-SW

Data acquiring policy
File maintenance service



Data flow card service

ICS-SIM-

- Standard card: 30MB per month
- Large data flow card: 100MB per month
- Users can recharge their cards before the 12-month service life expires.



Cloud data storage service

ICS-DS-

- 6M: The data storage rolling period is 6 months.
- 12M: The data storage rolling period is 12 months.



Cloud platform use and maintenance

ICS-PF

INVT cloud platform use and maintenance

Data flow card service

- Standard card: 30MB per month
- Large data flow card: 100MB per month. Users can recharge their cards before the 12-month service life expires

API service

- CS-API: A third-party system can obtain device real-time data, facilitating remote device control and remote program upgrade.
- Standard version: The service application system provides data interfaces, for third-party systems to invoke data.
- Customized version: Data interfaces can be customized based on third-party system requirements.

Policy file maintenance service

- ICS-SW: Data acquiring policy file maintenance service, implementing the upgrade or update on different data points of monitored devices

Cloud platform use and maintenance

- INVT cloud platform use and maintenance

Cloud data storage service

- 6M: The data storage rolling period is 6 months
- 12M: The data storage rolling period is 12 months

Air compressor IoT comprehensive service management platform

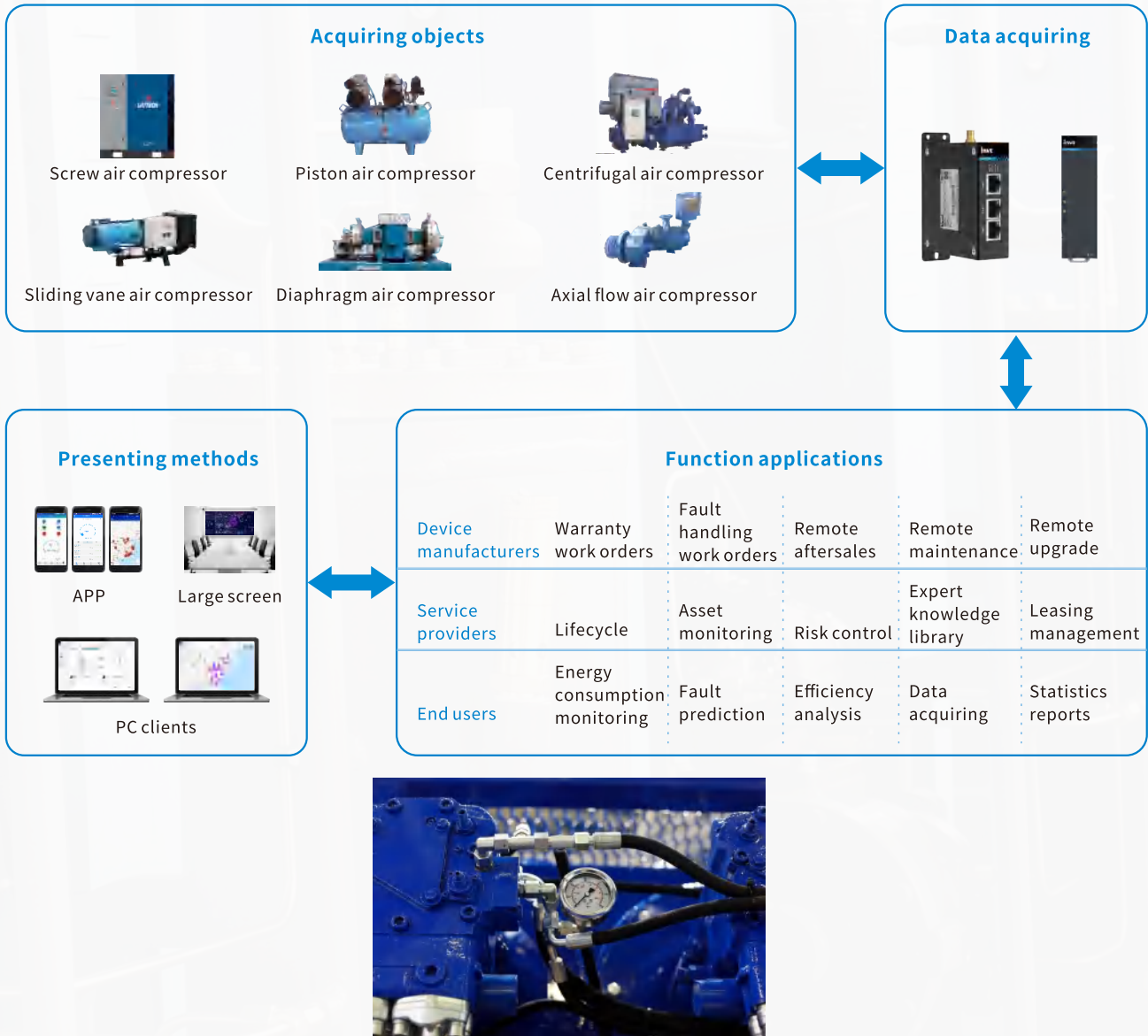

● Solutions

1. Saving aftersales costs: Remote aftersales can improve overall aftersales efficiency and reduce aftersales costs.
2. Device status monitoring and operation analysis: The best economic efficiency of replacing vulnerable and consumable parts can be achieved by real-time detection and intelligent analysis of these parts of air compressor.
3. IoT supervision and online leasing business: The ownership of leased device is separated from operational services, improving efficiency and reducing risks.
4. Refined energy consumption management: Through the IoT management, an enterprise can achieve a reduction of approximately 10% in energy consumption under the same operating conditions, saving at least RMB 700,000 in energy consumption costs annually.

Multi-Device Joint Control System for Air Compressor Applications

By leveraging intelligent algorithms, the system optimizes air compressor operation to reduce energy consumption, enhance

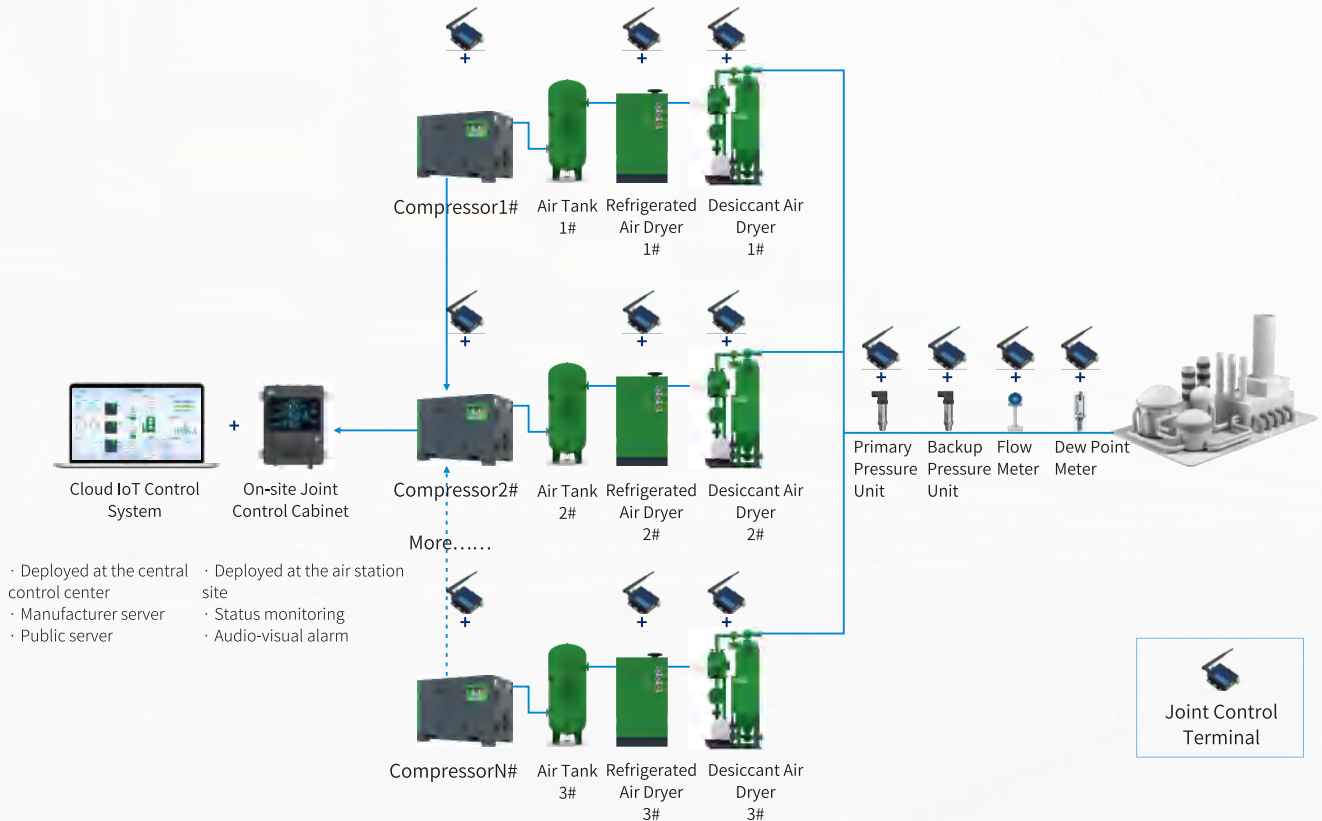

ICA Joint Control Cabinet

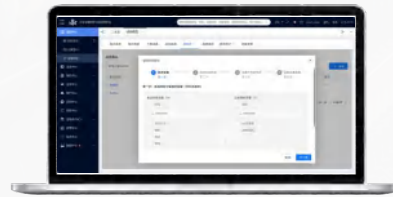

Algorithm Configuration

Station-Wide Energy Saving

From single-unit optimization to system-level efficiency

Equipment utilization rate, specific energy consumption, cumulative power consumption, etc

From “Cruise Control” to “Autonomous Operation”

Using conditional algorithms, the system automatically adjusts loading and unloading based on actual equipment operating conditions to ensure continuous and efficient operation

Actual Effect of Single Pressure Band Operation

Reduces pressure difference between devices, maintains constant pressure, and minimizes ineffective energy consumption in workshops

Big Data Visualization Technology

Comprehensive analysis of system investment returns, energy efficiency, control records, and 9 major analysis categories

Solution Value: Station-Wide Energy Saving

- 1.Reduce Idle Operation Waste:Balance air compressor operating time, switch equipment status in real time, and minimize idle running and unnecessary startup losses.
- 2.Lower Network Average Pressure:Multi-parameter control of main pipeline flow, main pipeline pressure, and terminal pressure reduces overall network pressure fluctuations.
- 3.Reduce Specific Energy Consumption:Through precise multi-parameter control (main pipeline flow, main and terminal pressure), network pressure fluctuations are minimized.Within the typical pressure range of 6–8 bar, every 1 bar reduction in discharge pressure can lower energy consumption by approximately 7%.

Construction machinery IoT smart management platform

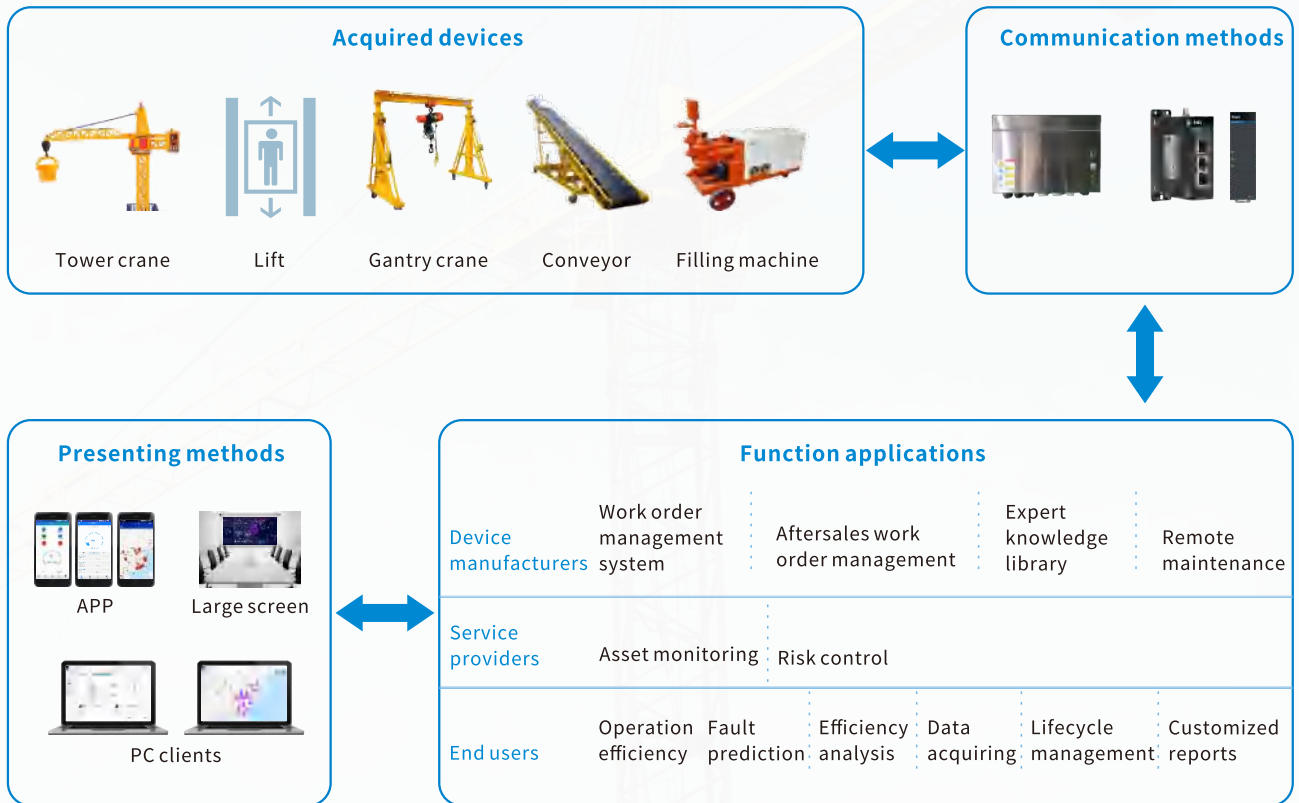

• Solution

Device manufacturers

1. Fault work order management: can handle faults timely and accurately, improving user experience.
2. Aftersales and maintenance work order management: can rigger maintenance tasks actively through remote aftersales and remote control, enhancing customer stickiness, and driving accessory sales.
3. Expert knowledge library management: precise fault handling suggestions pushing to assist in efficient management.

Service providers

1. Risk control: By combining IoT technology to achieve online leasing business, separating ownership of leased device from operational services, improving efficiency and controlling risks.
2. Timely reminder of payment: For device service providers' leasing business, a reminder of lease expiration can be provided to reduce repayment risks.

End users

1. Device monitoring: Real time monitoring of device status and implementation of over limit alarm mechanism for key parameters to ensure onsite safety production.
2. With the help of IoT terminal devices on construction sites, onsite inspectors can track device conditions and respond promptly to emergency situations.
3. Data report management: can generate health data for devices, facilitating maintenance operations, preventing faults, and timely notifying manufacturers for repairs.
4. Full lifecycle management of construction machinery: all device data is fully recorded for engineers to access.

PV water pump IoT smart management platform

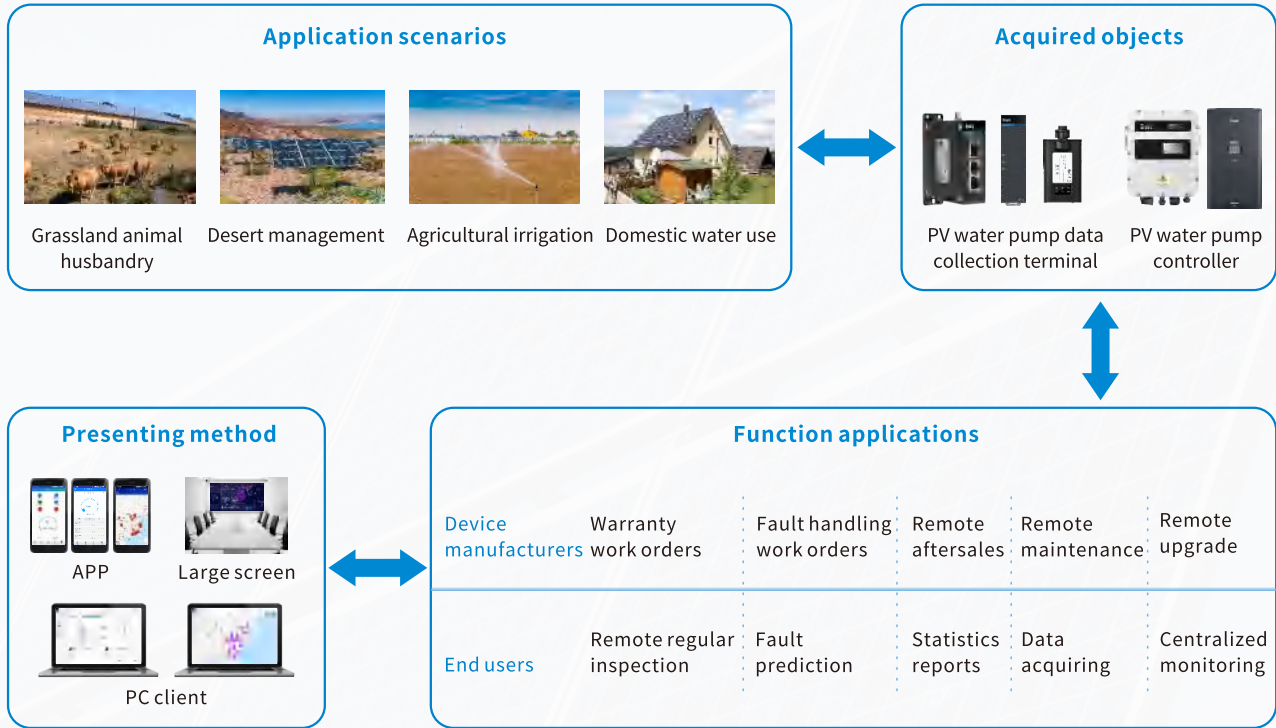

PV water pump IoT platform

● Solution

1. Smart regular inspection and efficient O&M: can realize remote monitoring and analysis of PV water pump faults and exceptions, effectively solving practical problems such as difficult monitoring and control of PV water pumps, inspection difficulty, and low O&M effectiveness. Ultimately, the annual cost of O&M and inspection can be reduced by 30%.
2. Panoramic monitoring: can acquire operational data information such as voltage, current, and power of PV water pumps in real time, comprehensively monitor the operation of PV devices, and make intelligent analysis to achieve maximum operational efficiency of the entire PV water pump system.
3. PV water pump devices can be remotely controlled through computers and mobile phones, and key parameters of the devices can be remotely regulated.

Smart factory solution—Energy saving, emission reduction, production increase and efficiency enhancement

The smart factory solution is a full lifecycle management system for a digital factory or product from requirements to design, production, operation, and maintenance. The purpose is to summarize and integrate the manufacturing data, operation data, maintenance data, and then analyze and process the data through big data analysis systems and artificial intelligence systems, ultimately completing the optimization, production capacity improvement, efficient operation, remote pre-maintenance.

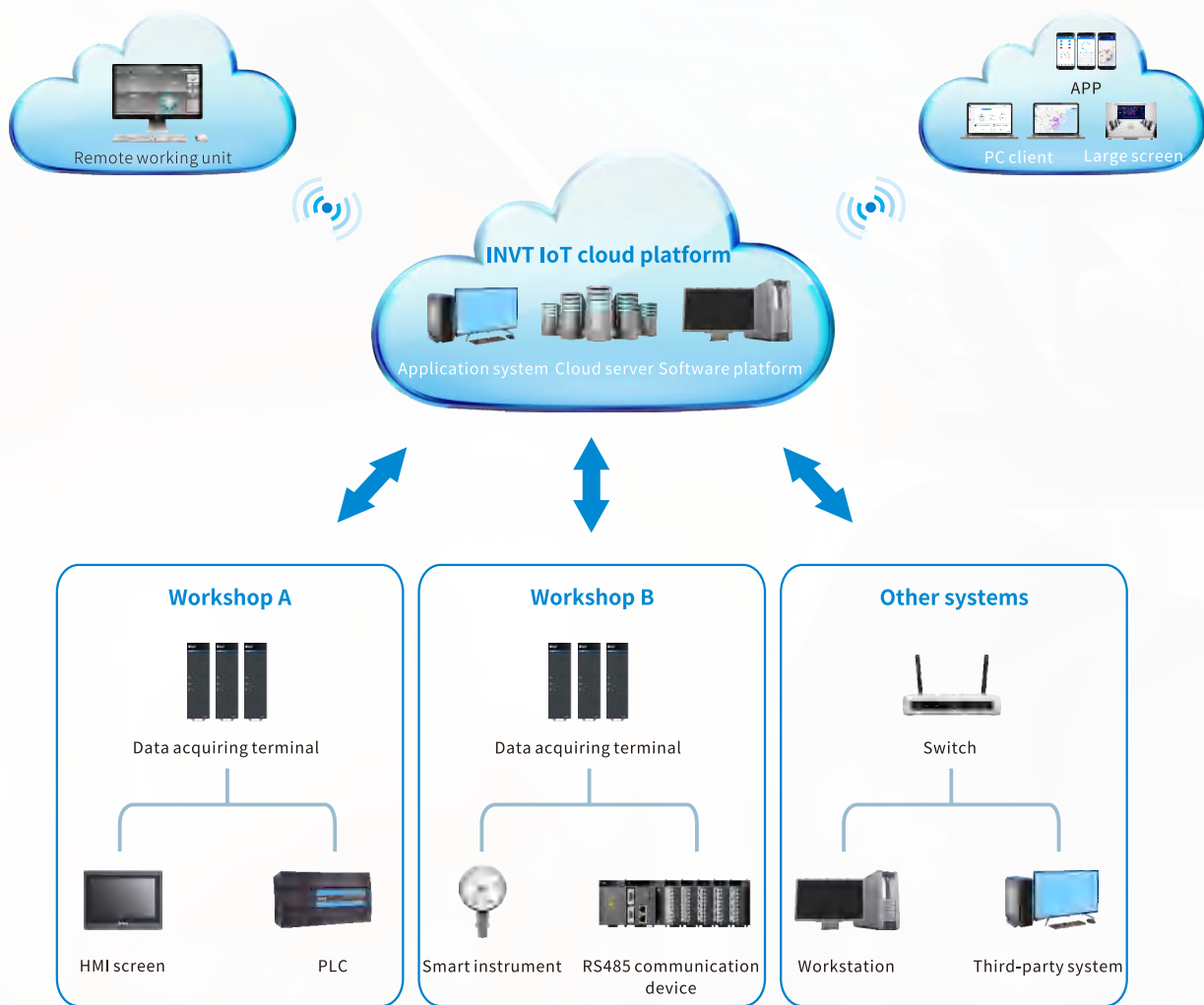

INVT IoT solution gradually achieves the goal of energy saving, emission reduction, and production increase and efficiency enhancement in smart factories in three stages:

1. To realize the interconnection and intercommunication of various industrial device data in the factory.
2. To manage factory device energy consumption and faults.
3. To establish a mathematical model for device energy saving, emission reduction, and production increase and efficiency enhancement by means of data analysis.

IESM - Elevator IoT monitoring and management platform

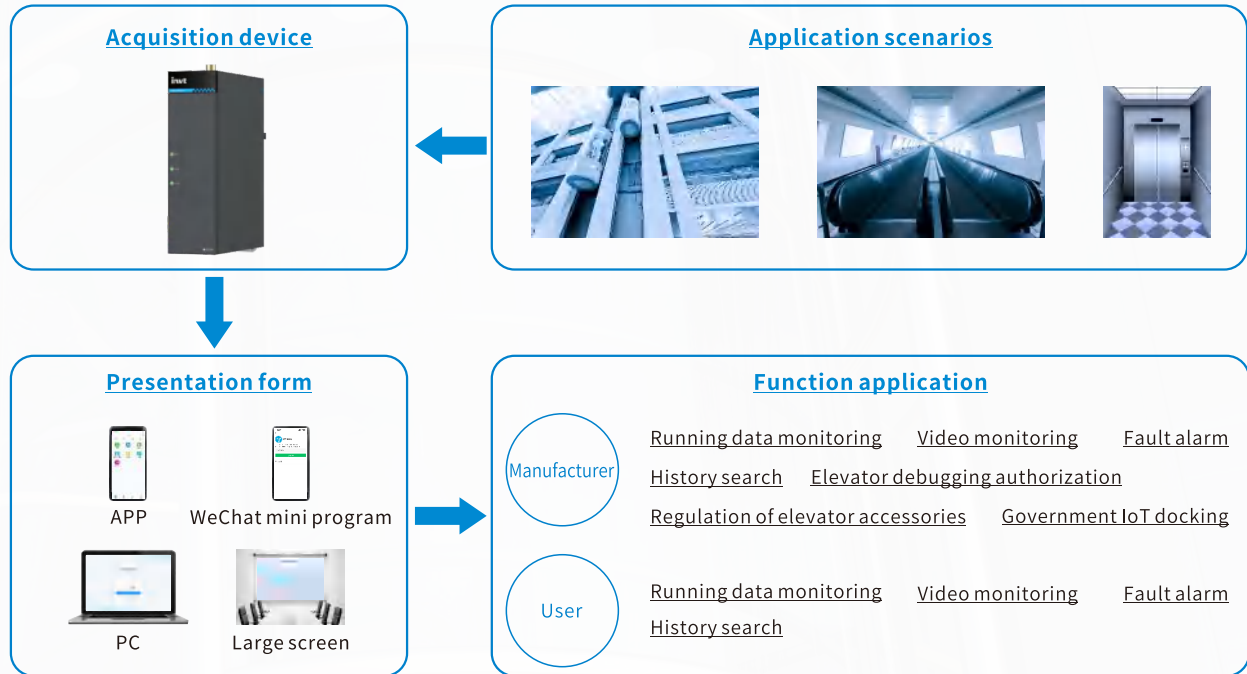

● **Solution**

1. Elevator debugging tools: The elevator main control and other auxiliary boards can be debugged through the APP, and the debugging permissions of the elevator can be supervised, so that only authorized personnel can perform elevator debugging.
2. "Digital housekeeper" of elevators: The accessories of elevators are supervised to ensure that only authorized elevator components can be installed for normal use, and avoid the use of illegal components that may affect the safety of elevator operation.
3. Real-time monitoring of operation status: Maintenance personnel can understand the health of the elevator at the first time, and take targeted measures.
4. Automatic push of faults and alarms: When a fault occurs, maintenance personnel will be notified in a timely manner through SMS. When a critical fault occurs (people trapped), the platform can automatically call the maintenance phone to timely appease the trapped personnel.
5. Data docking with government platforms: Currently, the docking work has been achieved in Shanghai, Hangzhou, Jiaxing, Jinhua, Ningbo, Shenyang, Fuzhou, Liaoning, Huzhou, Lishui and other places.

Textile IoT smart management platform

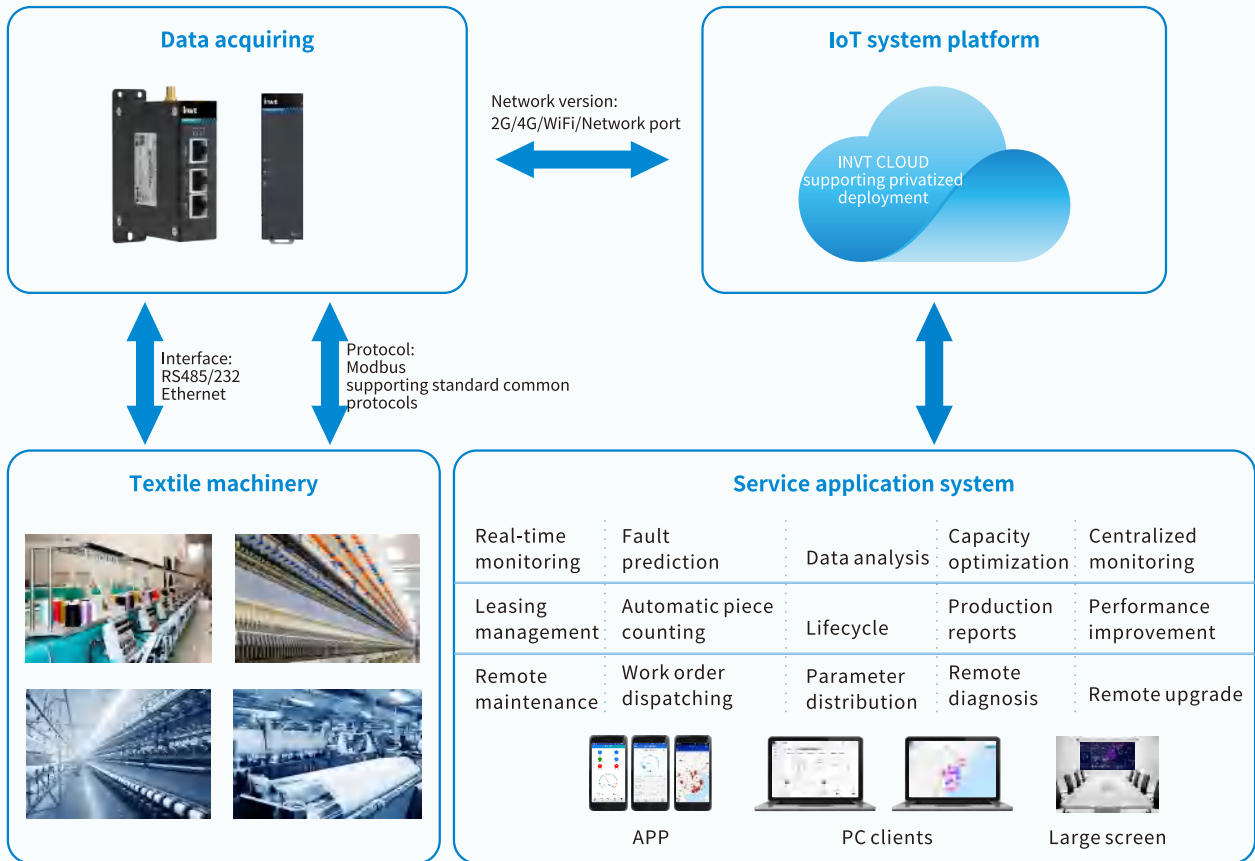

Textile process production line

● Solution

1. It realizes remote monitoring of textile production line device, batch parameter distribution, real-time monitoring of device status, improving production efficiency.
2. It realizes remote fault prediction, reducing downtime of textile production line device, ensuring system stability, and reminding of periodic device maintenance.
3. It realizes the integration of IoT platform with enterprise ERP, PLM, CRM, SCM and other management information systems, helping enterprises in efficient resource flow and integration from product design to production, and ensuring the stability and efficiency of production.

Small PLC

Medium PLC

X86 Controller

I/O System

HMI

Industrial Internet

Your Trusted Industry Automation Solution Provider



E-mail: overseas@invt.com.cn Website: www.invt.com

SHENZHEN INVT ELECTRIC CO.,LTD. INVT Guangming Technology Building, Songbai Road, Matian, Guangming District, Shenzhen, China

- Industrial Automation:**
- HMI
 - PLC
 - VFD
 - Servo System
 - Elevator Intelligent Control System
 - Rail Transit Traction System
- Electric Power:**
- UPS
 - DCIM
 - Solar Inverter
 - New Energy Vehicle Powertrain System
 - New Energy Vehicle Charging System
 - New Energy Vehicle Motor

INVT Copyright.
Information may be subject to change without notice during product improving.

66003-00274

202511(V4.0)